

2024 Outdoor Products Price List

Hearth Dealer

USA Pricing - MSRP



Effective May 1, 2024

Updated
6/25/24

Registered trademarks property of Travis Industries®
All images and names Copyright © 2023

TABLE OF CONTENTS

<u>OUTDOOR FIREPIT BURNERS</u>	<u>PAGE#</u>	<u>OUTDOOR TORCHES</u>	<u>PAGE#</u>
36" Firepit Burner	3	Tempest Torch	29
60" Firepit Burner	4	Tempest 20K Lanterns	31
72" Firepit Burner	5	Tempest 50k Lantern	33
96" Firepit Burner	6		
120" Firepit Burner	7		
		<u>MISCELLANEOUS</u>	
		Custom Plate Kit Order Form	34
<u>OUTDOOR COMPLETE FIREPITS</u>			
48" Complete Firepit	8		
72" Complete Firepit	9		
84" Complete Firepit	10		
108" Complete Firepit	11		
132" Complete Firepit	12		
<u>OUTDOOR GAS FIREPLACES</u>			
4024 Linear Outdoor Gas Fireplace	13		
4024 Linear See-Thru Outdoor Gas Fireplace	14		
6424 Linear Outdoor Gas Fireplace	15		
6424 Linear See-Thru Outdoor Gas Fireplace	16		
4035 Traditional Outdoor Gas Fireplace	17		
<u>OUTDOOR TABLE</u>			
44" Chat Table	18		
<u>OUTDOOR VORACIOUS FIRE BURNERS</u>			
10" Voracious Fire Burner	19		
13" Voracious Fire Burner	21		
18" Voracious Fire Burner	23		
22" Voracious Fire Burner	25		
32" Voracious Fire Burner	27		

TERMS & PRICES SUBJECT TO CHANGE WITHOUT PRIOR NOTICE:

1. All prices are FOB origin.
2. Not all units and accessories are guaranteed in stock at the local warehouse.
Contact your s Manager for availability.
3. Standard Terms are 2%/15, Net 30 upon approval of credit.
4. Possession of this Price list does not constitute an offer to sell.
5. Any returned items must be pre-authorized and accompanied by an RMA form within 180 days of purchase date. There will be a 20% restocking charge.
6. A \$7.00 handling fee is added to all UPS ground & US mail orders.





12521 Harbour Reach Drive - Mukilteo, WA 98275
 Phone Order Line: (800) 654-1177
 Technical Service Line: (888) 298-1616
 Web Address: www.firegardenoutdoors.com



36" Firepit Burner

Model	SKU #	Wt. Lbs							MSRP
<p>Firepit Burner- 36" 65,000 BTUs. Includes stainless steel burner, 3/8" thick, 6" tall tempered glass wind guard with chrome hardware standard, 2 air vents, key valve kit (shut off), 24V AC Hot Shot™ electronic ignition (patent pending) and Natural gas with an LP conversion kit.</p> 	94900430	66							\$2,862

STEP #1 - SELECT A SINGLE MODEL OR MULTIPLE MODEL TRANSFORMER

Required	SKU #	Wt.					MSRP
<p>Single Model Transformer Has single 24v lead up to 95ft. Can run 1 Fire Garden™ Product.</p> 	94800833	5					\$184
<p>Multiple Model Transformer Has 24V/26V/28V leads. Can run up to six Fire Garden™ Products. Transformer can be located up to 1000ft. from single unit, or approximately 100ft from group of six units.</p> 	94800830	15					\$292



STEP #2 - SELECT A CRUSHED GLASS COLOR OR TUMBLED STONES

Required	SKU #	Wt.				MSRP
<p>10 LBS PER BOX</p> <p>Uses 15 lbs</p>	<p>Platinum</p> 	94500580	10	<p>Requires 2 Boxes</p>		\$114
	<p>Bronze</p> 	94500581	10		\$114	
	<p>Cobalt</p> 	94500582	10		\$114	
	<p>Black</p> 	94500583	10		\$114	
<p>Uses 30 lbs Small AND 20 lbs Large</p>	<p>Tumbled Stones</p> <p>10 lbs Small Rock</p> 	94500985	11	<p>Requires 3 Boxes AND Requires 1 Box</p>		\$74
	<p>20 lbs Large Rock</p>	94500986	21		\$116	





60" Firepit Burner

Model	SKU #	Wt. Lbs							MSRP
<p>Firepit Burner - 60" 120,000 BTUs. Includes stainless steel burner, 3/8" thick, 6" tall tempered glass wind guard with chrome hardware standard, 2 air vents, key valve kit (shut off), 24V AC Hot Shot™ electronic ignition (patent pending) and Natural gas with an LP conversion kit.</p> 	94900447	99							\$3,516

STEP #1 - SELECT A SINGLE MODEL OR MULTIPLE MODEL TRANSFORMER

Required	SKU #	Wt.					MSRP
<p>Single Model Transformer Has single 24v lead up to 95ft. Can run 1 Fire Garden™ Product.</p> 	94800833	5					\$184
<p>Multiple Model Transformer Has 24V/26V/28V leads. Can run up to six Fire Garden™ Products. Transformer can be located up to 1000ft. from single unit, or approximately 100ft from group of six units.</p> 	94800830	15					\$292

STEP #2 - SELECT A CRUSHED GLASS COLOR OR TUMBLED STONES

Required	SKU #	Wt.				MSRP
<p>10 LBS PER BOX</p> <p>Uses 25 lbs</p>	<p>Platinum</p> 	94500580	10	<p>Requires 3 Boxes</p>		\$114
	<p>Bronze</p> 	94500581	10			\$114
	<p>Cobalt</p> 	94500582	10			\$114
	<p>Black</p> 	94500583	10			\$114
<p>Tumbled Stones</p> <p>Uses 50 lbs Small AND 20 lbs Large</p>	<p>10 lbs Small Rock</p> 	94500985	11	<p>Requires 5 Boxes AND Requires 1 Box</p>		\$74
	<p>20 lbs Large Rock</p>	94500986	21			\$116

72" Firepit Burner

Model	SKU #	Wt. Lbs							MSRP
Firepit Burner - 72" 132,000 BTUs. Includes stainless steel burner, 3/8" thick , 6" tall tempered glass wind guard with chrome hardware standard, 2 air vents, key valve kit (shut off), 24V AC Hot Shot™ electronic ignition (patent pending) and Natural gas with an LP conversion kit.	94900452	164							\$4,946



72" FIREPIT BURNER IS CUSTOM MADE, PLEASE ALLOW 4-8 WEEKS FOR DELIVERY



Required	SKU #	Wt.					MSRP
Multiple Model Transformer Has 24V/26V/28V leads. Can run up to six Fire Garden™ Products. Transformer can be located up to 1000ft. from single unit, or approximately 100ft from group of six units.	94800830	15					\$292







STEP #1 - SELECT A CRUSHED GLASS COLOR OR TUMBLED STONES

Required	SKU #	Wt.				MSRP
10 LBS PER BOX Uses 30 lbs	Platinum 	94500580	10	Requires 3 Boxes		\$114
	Bronze 	94500581	10			
	Cobalt 	94500582	10			
	Black 	94500583	10			
Uses 60 lbs Small AND 40 lbs Large	Tumbled Stones 10 lbs Small Rock 	94500985	11	Requires 6 Boxes AND Requires 2 Boxes		\$74
	20 lbs Large Rock 	94500986	21			\$116

96" Firepit Burner

Model	SKU #	Wt. Lbs							MSRP
<p>Firepit Burner - 96" 185,000 BTUs. Includes stainless steel burner, 3/8" thick , 6" tall tempered glass wind guard with chrome hardware standard, 2 air vents, key valve kit (shut off), 24V AC Hot Shot™ electronic ignition (patent pending) and Natural gas with an LP conversion kit.</p> 	94900460	218							\$5,634
Required	SKU #	Wt.							MSRP
<p>Multiple Model Transformer Has 24V/26V/28V leads. Can run up to six Fire Garden™ Products. Transformer can be located up to 1000ft. from single unit, or approximately 100ft from group of six units.</p> 	94800830	15							\$292

STEP #1 - SELECT A CRUSHED GLASS COLOR OR TUMBLED STONES

Required	SKU #	Wt.				MSRP
<p>10 LBS PER BOX</p> <p>Uses 35 lbs</p>	<p>Platinum</p> 	94500580	10	<p>Requires 4 Boxes</p>		\$114
	<p>Bronze</p> 	94500581	10		\$114	
	<p>Cobalt</p> 	94500582	10		\$114	
	<p>Black</p> 	94500583	10		\$114	
<p>Uses 80 lbs Small AND 40 lbs Large</p>	<p>Tumbled Stones</p> <p>10 lbs Small Rock</p> 	94500985	11	<p>Requires 8 Boxes AND Requires 2 Boxes</p>		\$74
	<p>20 lbs Large Rock</p>	94500986	21		\$116	

120" Firepit Burner

Model	SKU #	Wt. Lbs							MSRP
Firepit Burner - 120" 240,000 BTUs. Includes stainless steel burner, 3/8" thick, 6" tall tempered glass wind guard with chrome hardware standard, 2 air vents, key valve kit (shut off), 24V AC Hot Shot™ electronic ignition (patent pending) and Natural gas with an LP conversion kit.	94900465	248							\$6,568







120" FIREPIT BURNER IS CUSTOM MADE, PLEASE ALLOW 4-8 WEEKS FOR DELIVERY

Required	SKU #	Wt.						MSRP
Multiple Model Transformer Has 24V/26V/28V leads. Can run up to six Fire Garden™ Products. Transformer can be located up to 1000ft. from single unit, or approximately 100ft from group of six units.	94800830	15						\$292





STEP #1 - SELECT A CRUSHED GLASS COLOR OR TUMBLED STONES

Required	SKU #	Wt.					MSRP
10 LBS PER BOX Uses 50 lbs	Platinum 	94500580	10	Requires 5 Boxes			\$114
	Bronze 	94500581	10				\$114
	Cobalt 	94500582	10				\$114
	Black 	94500583	10				\$114
Uses 100 lbs Small AND 40 lbs Large	Tumbled Stones 10 lbs Small Rock 	94500985	11	Requires 10 Boxes AND Requires 2 Boxes			\$74
	20 lbs Large Rock	94500986	21				\$116





48" Complete Firepit

Model	SKU #	Wt. Lbs							MSRP
<p>Complete Firepit - 48" 65,000 BTUs. Includes fully assembled stainless steel burner, key valve kit (shut off), 3/8" thick, 6" tall tempered glass wind guard with chrome hardware standard, powder coated, 24V AC Hot Shot™ electronic ignition(patent pending) and Natural gas with an LP conversion kit.</p> <p>Graphite Powder Coat</p> 	94900432	172							\$4,026

STEP #1 - SELECT A SINGLE MODEL OR MULTIPLE MODEL TRANSFORMER

Required	SKU #	Wt.					MSRP
<p>Single Model Transformer Has single 24v lead up to 95ft. Can run 1 Fire Garden™ Product.</p> 	94800833	5					\$184
<p>Multiple Model Transformer Has 24V/26V/28V leads. Can run up to six Fire Garden™ Products. Transformer can be located up to 1000ft. from single unit, or approximately 100ft from group of six units.</p> 	94800830	15					\$292



STEP #2 - SELECT A CRUSHED GLASS COLOR OR TUMBLED STONES

Required	SKU #	Wt.				MSRP
<p>10 LBS PER BOX</p> <p>Uses 15 lbs</p>	<p>Platinum</p> 	94500580	10	<p>Requires 2 Boxes</p>		\$114
	<p>Bronze</p> 	94500581	10		\$114	
	<p>Cobalt</p> 	94500582	10		\$114	
	<p>Black</p> 	94500583	10		\$114	
<p>Tumbled Stones</p> <p>Uses 30 lbs Small AND 20 lbs Large</p>	<p>10 lbs Small Rock</p> 	94500985	11	<p>Requires 3 Boxes AND Requires 1 Box</p>		\$74
	<p>20 lbs Large Rock</p>	94500986	21		\$116	





72" Complete Firepit

Model	SKU #	Wt. Lbs							MSRP
<p>Complete Firepit - 72" 120,000 BTUs. Includes fully assembled stainless steel burner, key valve kit (shut off), 3/8" thick , 6" tall tempered glass wind guard with chrome hardware standard, powder coated, 24V AC Hot Shot™ electronic ignition (patent pending), Natural gas with an LP conversion kit.</p>  <p>Graphite Powder Coat</p>	94900449	233							\$4,830

STEP #1 - SELECT A SINGLE MODEL OR MULTIPLE MODEL TRANSFORMER

Required	SKU #	Wt.					MSRP
<p>Single Model Transformer Has single 24v lead up to 95ft. Can run 1 Fire Garden™ Product.</p> 	94800833	5					\$184
<p>Multiple Model Transformer Has 24V/26V/28V leads. Can run up to six Fire Garden™ Products. Transformer can be located up to 1000ft. from single unit, or approximately 100ft from group of six units.</p> 	94800830	15					\$292

STEP #2 - SELECT A CRUSHED GLASS COLOR OR TUMBLED STONES

Required	SKU #	Wt.				MSRP
<p>10 LBS PER BOX</p> <p>Uses 25 lbs</p>	<p>Platinum</p> 	94500580	10	<p>Requires 3 Boxes</p>		\$114
	<p>Bronze</p> 	94500581	10			\$114
	<p>Cobalt</p> 	94500582	10			\$114
	<p>Black</p> 	94500583	10			\$114
<p>Tumbled Stones</p> <p>Uses 10 lbs Small Rock 50 lbs Small AND 20 lbs Large 20 lbs Large Rock</p> 	94500985	11	<p>Requires 5 Boxes AND Requires 1 Box</p>		\$74	
	94500986	21			\$116	

84" Complete Firepit **COMING SOON!**

10





Model	SKU #	Wt. Lbs							MSRP
Complete Firepit - 84" 132,000 BTUs. Includes fully assembled stainless steel burner, key valve kit (shut off), 3/8" thick , 6" tall tempered glass wind guard with chrome hardware standard, powder coated, 24V AC Hot Shot™ electronic ignition (patent pending), Natural gas with an LP conversion kit. 	94900453	250							\$5,980

Graphite Powder Coat



84" COMPLETE FIREPIT IS CUSTOM MADE, PLEASE ALLOW 4-8 WEEKS FOR DELIVERY

Required	SKU #	Wt.					MSRP
Multiple Model Transformer Has 24V/26V/28V leads. Can run up to six Fire Garden™ Products. Transformer can be located up to 1000ft. from single unit, or approximately 100ft from group of six units. 	94800830	15					\$292



STEP #1 - SELECT A CRUSHED GLASS COLOR OR TUMBLED STONES

Required	SKU #	Wt.				MSRP
10 LBS PER BOX Uses 30 lbs	Platinum 	94500580	10	Requires 3 Boxes		\$114
	Bronze 	94500581	10			
	Cobalt 	94500582	10			
	Black 	94500583	10			
Uses 60 lbs Small AND 40 lbs Large	Tumbled Stones 10 lbs Small Rock 	94500985	11	Requires 6 Boxes AND Requires 2 Boxes		\$74
	20 lbs Large Rock	94500986	21			\$116

108" Complete Firepit

Model	SKU #	Wt. Lbs							MSRP
<p>Complete Firepit - 108" 185,000 BTUs. Includes fully assembled stainless steel burner, key valve kit (shut off), 3/8" thick , 6" tall tempered glass wind guard with chrome hardware standard, powder coated, 24V AC Hot Shot™ electronic ignition (patent pending), Natural gas with an LP conversion kit.</p>  <p>Graphite Powder Coat</p>	94900461	367							\$7,532
Required	SKU #	Wt.							MSRP
<p>Multiple Model Transformer Has 24V/26V/28V leads. Can run up to six Fire Garden™ Products. Transformer can be located up to 1000ft. from single unit, or approximately 100ft from group of six units.</p> 	94800830	15							\$292

STEP #1 - SELECT A CRUSHED GLASS COLOR OR TUMBLED STONES

Required	SKU #	Wt.					MSRP
<p>10 LBS PER BOX</p> <p>Uses 35 lbs</p>	<p>Platinum</p> 	94500580	10	<p>Requires 4 Boxes</p>			\$114
	<p>Bronze</p> 	94500581	10			\$114	
	<p>Cobalt</p> 	94500582	10			\$114	
	<p>Black</p> 	94500583	10			\$114	
<p>Tumbled Stones</p> <p>Uses 80 lbs Small AND 40 lbs Large</p>	<p>10 lbs Small Rock</p> 	94500985	11	<p>Requires 8 Boxes AND Requires 2 Boxes</p>			\$74
	<p>20 lbs Large Rock</p>	94500986	21			\$116	

132" Complete Firepit

Model	SKU #	Wt. Lbs							MSRP
<p>Complete Firepit - 132" 240,000 BTUs. Includes fully assembled stainless steel burner, key valve kit (shut off), 3/8" thick , 6" tall tempered glass wind guard with chrome hardware standard, powder coated, 24V AC Hot Shot™ electronic ignition (patent pending), Natural gas with an LP conversion kit.</p> <p>Graphite Powder Coat</p> 	94900467	350							\$8,464

132" COMPLETE FIREPIT IS CUSTOM MADE, PLEASE ALLOW 4-8 WEEKS FOR DELIVERY

Required	SKU #	Wt.					MSRP
<p>Multiple Model Transformer Has 24V/26V/28V leads. Can run up to six Fire Garden™ Products. Transformer can be located up to 1000^{ft.} from single unit, or approximately 100^{ft.} from group of six units.</p> 	94800830	15					\$292



STEP #1 - SELECT A CRUSHED GLASS COLOR OR TUMBLED STONES

Required	SKU #	Wt.				MSRP
<p>10 LBS PER BOX</p> <p>Uses 50 lbs</p>	<p>Platinum</p> 	94500580	10	<p>Requires 5 Boxes</p>		\$114
	<p>Bronze</p> 	94500581	10			
	<p>Cobalt</p> 	94500582	10			
	<p>Black</p> 	94500583	10			
<p>Tumbled Stones</p> <p>Uses 10 lbs Small Rock 100 lbs Small AND 40 lbs Large 20 lbs Large Rock</p> 	94500985	11	<p>Requires 10 Boxes AND Requires 2 Boxes</p>		\$74	
	94500986	21			\$116	



4024 Linear Outdoor Gas Fireplace

Model	SKU #	Wt. Lbs							MSRP
Linear Outdoor Gas Fireplace - 36" Burner 65,000 BTUs. Viewing Area: 40" W x 24" H. Includes stainless steel firebox and burner, standard LP conversion kit, 3/8" tempered glass wind screen 6" tall, standard black glass fireback, 2 air vents and key valve kit (shut off). 	94900290	334							\$4,724

STEP #1 - SELECT A SINGLE MODEL OR MULTIPLE MODEL TRANSFORMER

Required	SKU #	Wt.					MSRP
Single Model Transformer Has single 24v lead up to 95ft. Can run 1 Fire Garden™ Product. 	94800833	5					\$184
Multiple Model Transformer Has 24V/26V/28V leads. Can run up to six Fire Garden™ Products. Transformer can be located up to 1000ft. from single unit, or approximately 100ft from group of six units. 	94800830	15					\$292

STEP #2 - SELECT A CRUSHED GLASS COLOR OR TUMBLED STONES

Required	SKU #	Wt.				MSRP
10 LBS PER BOX Uses 25 lbs	Platinum 	94500580	10	Requires 3 Boxes		\$114
	Bronze 	94500581	10			
	Cobalt 	94500582	10			
	Black 	94500583	10			
Tumbled Stones Uses 50 lbs Small AND 20 lbs Large	10 lbs Small Rock 	94500985	11	Requires 5 Boxes AND Requires 1 Box		\$74
	20 lbs Large Rock	94500986	21			\$116



STEP #3 - ADD YOUR EXTRAS

Notable Extra	SKU #	Wt.				MSRP
Lifting Handles Includes 2 Handles Service Part ONLY STOCKED IN WA 	98500711	11				\$76





4024 Linear See-Thru Outdoor Gas Fireplace

Model	SKU #	Wt. Lbs							MSRP
Linear See-Thru Outdoor Gas Fireplace - 36" Burner 65,000 BTUs. Viewing Area: 40" W x 24" H. Includes stainless steel firebox and burner, standard LP conversion kit, 3/8" tempered glass wind screen 6" tall, standard black glass fireback, 2 air vents, key valve kit (shut off). 	94900296	312							\$4,534

STEP #1 - SELECT A SINGLE MODEL OR MULTIPLE MODEL TRANSFORMER

Required	SKU #	Wt.					MSRP
Single Model Transformer Has single 24v lead up to 95 ^{ft} . Can run 1 Fire Garden™ Product. 	94800833	5					\$184
Multiple Model Transformer Has 24V/26V/28V leads. Can run up to six Fire Garden™ Products. Transformer can be located up to 1000 ^{ft} . from single unit, or approximately 100 ^{ft} from group of six units. 	94800830	15					\$292

STEP #2 - SELECT A CRUSHED GLASS COLOR OR TUMBLED STONES

Required	SKU #	Wt.				MSRP
10 LBS PER BOX Uses 25 lbs	Platinum 	94500580	10	Requires 3 Boxes		\$114
	Bronze 	94500581	10			
	Cobalt 	94500582	10			
	Black 	94500583	10			
Tumbled Stones Uses 10 lbs Small Rock 50 lbs Small AND 20 lbs Large 20 lbs Large Rock 	94500985	11	Requires 5 Boxes AND Requires 1 Box		\$74	
	94500986	21			\$116	

STEP #3 - ADD YOUR EXTRAS

Notable Extra	SKU #	Wt.				MSRP
Lifting Handles Includes 2 Handles Service Part ONLY STOCKED IN WA 	98500711	11				\$76

6424 Linear Outdoor Gas Fireplace

15

Model	SKU #	Wt. Lbs							MSRP
Linear Outdoor Gas Fireplace - 60" Burner 120,000 BTUs. Viewing Area: 64" W x 24" H. Includes stainless steel firebox and burner, standard LP conversion kit, 3/8" tempered glass wind screen 6" tall, standard black glass fireback, 2 air vents and key valve kit (shut off).	94900300	452							\$6,182







STEP #1 - SELECT A SINGLE MODEL OR MULTIPLE MODEL TRANSFORMER

Required	SKU #	Wt.					MSRP
Single Model Transformer Has single 24v lead up to 95ft. Can run 1 Fire Garden™ Product.	94800833	5					\$184
Multiple Model Transformer Has 24V/26V/28V leads. Can run up to six Fire Garden™ Products. Transformer can be located up to 1000ft. from single unit, or approximately 100ft from group of six units.	94800830	15					\$292



STEP #2 - SELECT A CRUSHED GLASS COLOR OR TUMBLED STONES

Required	SKU #	Wt.				MSRP
10 LBS PER BOX Uses 40 lbs	Platinum 	94500580	10	Requires 4 Boxes		\$114
	Bronze 	94500581	10			
	Cobalt 	94500582	10			
	Black 	94500583	10			
Uses 80 lbs Small AND 20 lbs Large	Tumbled Stones 10 lbs Small Rock	94500985	11	Requires 8 Boxes AND Requires 1 Box		\$74
	20 lbs Large Rock	94500986	21			\$116



STEP #3 - ADD YOUR EXTRAS



Notable Extra	SKU #	Wt.				MSRP
Lifting Handles Includes 2 Handles Service Part ONLY STOCKED IN WA	98500711	11				\$76





6424 Linear See-Thru Outdoor Gas Fireplace

Model	SKU #	Wt. Lbs							MSRP
Linear See-Thru Outdoor Gas Fireplace - 60" Burner 120,000 BTUs. Viewing Area: 64" W x 24" H. Includes stainless steel firebox and burner, standard LP conversion kit, 3/8" tempered glass wind screen 6" tall, standard black glass fireback, 2 air vents and key valve kit (shut off). 	94900306	422							\$5,894

STEP #1 - SELECT A SINGLE MODEL OR MULTIPLE MODEL TRANSFORMER

Required	SKU #	Wt.					MSRP
Single Model Transformer Has single 24v lead up to 95ft. Can run 1 Fire Garden™ Product. 	94800833	5					\$184
Multiple Model Transformer Has 24V/26V/28V leads. Can run up to six Fire Garden™ Products. Transformer can be located up to 1000ft. from single unit, or approximately 100ft from group of six units. 	94800830	15					\$292

STEP #2 - SELECT A CRUSHED GLASS COLOR OR TUMBLED STONES

Required	SKU #	Wt.					MSRP
10 LBS PER BOX Uses 40 lbs	Platinum 	94500580	10	Requires 4 Boxes			\$114
	Bronze 	94500581	10			\$114	
	Cobalt 	94500582	10			\$114	
	Black 	94500583	10			\$114	
Uses 80 lbs Small AND 20 lbs Large	Tumbled Stones 10 lbs Small Rock 	94500985	11	Requires 8 Boxes AND Requires 1 Box			\$74
	20 lbs Large Rock	94500986	21			\$116	

STEP #3 - ADD YOUR EXTRAS

Notable Extra	SKU #	Wt.					MSRP
Lifting Handles Includes 2 Handles Service Part ONLY STOCKED IN WA 	98500711	11					\$76

4035 Traditional Outdoor Gas Fireplace **NEW!**

Model	SKU #	Wt. Lbs							MSRP
Traditional Outdoor Gas Fireplace - 95,000 BTUs. Viewing Area: 40" W x 35" H. Includes durable stainless steel construction and tube burners with integrated water weep holes, ventless model, 3/8" thick tempered glass, standard LP conversion kit and all-weather 24V AC Hot Shot™ electronic ignition.	94900325	411							\$4,716



STEP #1 - SELECT A SINGLE MODEL OR MULTIPLE MODEL TRANSFORMER

Required	SKU #	Wt.					MSRP
Single Model Transformer Has single 24v lead up to 95ft. Can run 1 Fire Garden™ Product.	94800833	5					\$184
Multiple Model Transformer Has 24V/26V/28V leads. Can run up to six Fire Garden™ Products. Transformer can be located up to 1000ft. from single unit, or approximately 100ft from group of six units.	94800830	15					\$292



STEP #2 - SELECT A LOG SET

Required	SKU #	Wt.				MSRP
Birch Log Set	94500982	26				\$1,182
Oak Log Set	94500983	26				\$1,056
Bon-Fyre Birch Log Set	94500979				PRICING COMING SOON	



STEP #3 - SELECT A FIREBACK

Required	SKU #	Wt.				MSRP
Handmade Brick	96100883				PRICING COMING SOON	
Black Glass	96100884	46				\$1,496



STEP #4 - ADD YOUR EXTRAS

Notable Extra	SKU #	Wt.				MSRP
Lifting Handles Includes 2 Handles Service Part ONLY STOCKED IN WA	98500711	11				\$76



44" Chat Table **NEW!**

Model	SKU #	Wt. Lbs							MSRP
44" Chat Table 20,000-65,000 BTUs. Includes a complete firepit table ready for propane tank, pulse ignition and safety shutoff, easy access hi/lo valve, graphite powder coat finish with stainless steel heavy duty drawer glides for the propane tanks easy access. 	94900350	236							\$3,364

STEP #1 - SELECT MEDIA FILLER KIT FOR CRUSHED GLASS ONLY

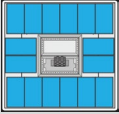
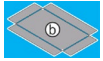

This kit provides aluminum filler shapes to take up some of the empty space around the burner thereby reducing the amount of glass media that is needed to cover the firepit bottom plate and cover the burner. The filler pieces are shipped flat and must be hand bent into shape before being installed in the firepit.

Media Filler Kit	SKU #	Wt.				MSRP
Requires: 4 of Kit 'B' 						
Filler Piece Shape 'B' Each Kit includes 4 pieces 	94601242	1	Requires 4 Kits			\$64

STEP #2 - SELECT A CRUSHED GLASS COLOR OR TUMBLED STONES

Required	SKU #	Wt.			MSRP
10 LBS PER BOX With Media Filler Kit Uses: 25 lbs Without Media Filler Kit Uses: 75 lbs Platinum 	94500580	10	Requires With Media Filler Kit 3 Boxes Without Media Filler Kit 8 Boxes		\$114
Bronze 	94500581	10		\$114	
Cobalt 	94500582	10		\$114	
Black 	94500583	10		\$114	
Uses Small 40 lbs AND Uses Large 40 lbs Tumbled Stones 10 lbs Small Rock  20 lbs Large Rock 	94500985	10	Requires 4 Boxes		\$74
	94500986	20	AND Requires 2 Boxes		\$116



STEP #3 - ADD YOUR EXTRAS

Notable Extras	SKU #	Wt.			MSRP
Glass Wind Guard 3/8" x 5" Tall 	94601180	20	NEW!		\$730
Hard Pipe Kit 	94601184	2	NEW!		\$190

10" Voracious Fire™ Burner

Model	SKU #	Wt. Lbs							MSRP
10" Voracious Fire™ Burner 65,000 BTUs NG Includes stainless steel burner, 1/4" thick aluminum plate base, 2 air vents, key valve kit (shut off), Z bracket, 24V AC Hot Shot™ electronic ignition (patent pending) and LP conversion kit. 	94900340	53							\$1,552

STEP #1 - SELECT A SINGLE MODEL OR MULTIPLE MODEL TRANSFORMER

Required	SKU #	Wt.					MSRP
Single Model Transformer Has single 24v lead up to 95ft. Can run 1 Fire Garden™ Product. 	94800833	5					\$184
Multiple Model Transformer Has 24V/26V/28V leads. Can run up to six Fire Garden™ Products. Transformer can be located up to 1000ft. from single unit, or approximately 100ft from group of six units. 	94800830	15					\$292

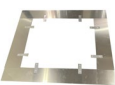
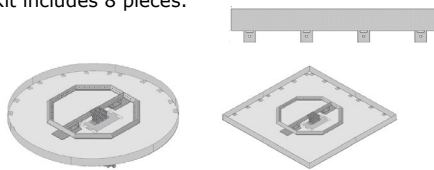

STEP #2 - SELECT A ROUND, SQUARE OR CUSTOM PLATE KIT

Required	SKU #	Wt.				MSRP
25" Round Plate Kit 	94601210	9				\$280
25" Square Plate Kit 	94601211	13				\$304
Custom Plate Kit over 27"	94601212				COST BY BID	
Notable Extra	SKU #	Wt.				MSRP
Pan Kit -Converts Plate to a Pan This optional kit adds a 2" high lip to the perimeter of the burner plate to contain the media. Each Kit includes 8 pieces. 	94601201	3			Requires Round or Square 1 Kit	\$104

10" Voracious Fire™ Burner

STEP #3 - SELECT MEDIA FILLER KIT FOR CRUSHED GLASS ONLY

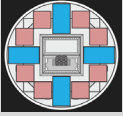
This kit provides aluminum filler shapes to take up some of the empty space around the burner thereby reducing the amount of glass media that is needed to cover the firepit bottom plate and cover the burner. The filler pieces are shipped flat and must be hand bent into shape before being installed in the firepit.

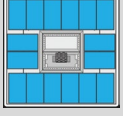
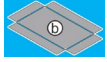
FOR ROUND PLATE Requires: 2 of Kit 'A' 1 of Kit 'B'		SKU #	Wt.			MSRP
Filler Piece Shape 'A' Each Kit includes 4 pieces		94601241	1	Requires 2 Kits		\$58
Filler Piece Shape 'B' Each Kit includes 4 pieces		94601242	1	Requires 1 Kit		\$64
FOR SQUARE PLATE Requires: 4 of Kit 'B'		SKU #	Wt.			MSRP
Filler Piece Shape 'B' Each Kit includes 4 pieces		94601242	1	Requires 4 Kits		\$64



STEP #4 - SELECT A CRUSHED GLASS COLOR OR TUMBLED STONES

Required		SKU #	Wt.			MSRP
10 LBS PER BOX With Media Filler Kit Uses Round: 30 lbs Square 25 lbs Without Media Filler Kit Uses Round: 60 lbs Square: 75 lbs	Platinum		94500580	10	Requires With Media Filler Kit Round: 3 Boxes Square: 3 Boxes Without Media Filler Kit Round: 6 Boxes Square: 8 Boxes	\$114
	Bronze		94500581	10		\$114
	Cobalt		94500582	10		\$114
	Black		94500583	10		\$114
Uses Small Round: 20 lbs Square: 40 lbs AND Uses Large Round: 20 lbs Square: 40 lbs	Tumbled Stones					
	10 lbs Small Rock	94500985	11	Requires Round: 2 Boxes Square: 4 Boxes AND Requires Round: 1 Box Square: 2 Boxes		\$74
20 lbs Large Rock	94500986	21				\$116

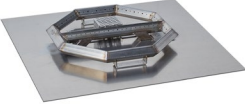

13" Voracious Fire™ Burner

Model	SKU #	Wt. Lbs							MSRP
13" Voracious Fire™ Burner 125,000 BTUs NG Includes stainless steel burner, 1/4" thick aluminum plate base, 2 air vents, key valve kit (shut off), Z bracket, 24V AC Hot Shot™ electronic ignition (patent pending) and LP conversion kit. 	94900341	57							\$1,706

STEP #1 - SELECT A SINGLE MODEL OR MULTIPLE MODEL TRANSFORMER

Required	SKU #	Wt.					MSRP
Single Model Transformer Has single 24v lead up to 95ft. Can run 1 Fire Garden™ Product. 	94800833	5					\$184
Multiple Model Transformer Has 24V/26V/28V leads. Can run up to six Fire Garden™ Products. Transformer can be located up to 1000ft. from single unit, or approximately 100ft from group of six units. 	94800830	15					\$292



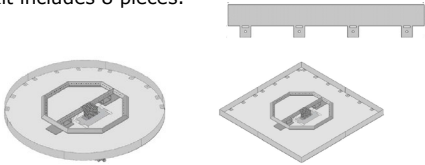

STEP #2 - SELECT A ROUND, SQUARE OR CUSTOM PLATE KIT

Required	SKU #	Wt.				MSRP
28" Round Plate Kit 	94601215	10				\$304
28" Square Plate Kit 	94601216	15				\$330
Custom Plate Kit over 30"	94601217				COST BY BID	
Notable Extra	SKU #	Wt.				MSRP
Pan Kit -Converts Plate to a Pan This optional kit adds a 2" high lip to the perimeter of the burner plate to contain the media. Each Kit includes 8 pieces. 	94601201	3		Requires Round or Square 1 Kit		\$104

13" Voracious Fire™ Burner

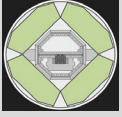
STEP #3 - SELECT MEDIA FILLER KIT FOR CRUSHED GLASS ONLY

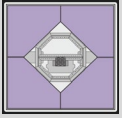
This Kit provides aluminum filler shapes to take up some of the empty space around the burner thereby reducing the amount of glass media that is needed to cover the firepit bottom plate and cover the burner. The filler pieces are shipped flat and must be hand bent into shape before being installed in the firepit.

FOR ROUND PLATE Requires: 1 of Kit 'D'		SKU #	Wt.			MSRP
Filler Piece Shape 'D' Each Kit includes 4 pieces		94601244	4	Requires 1 Kit		\$96
FOR SQUARE PLATE Requires: 1 of Kit 'C'		SKU #	Wt.			MSRP
Filler Piece Shape 'C' Each Kit includes 4 pieces		94601243	5	Requires 1 Kit		\$116



STEP #4 - SELECT A CRUSHED GLASS COLOR OR TUMBLED STONES

Required		SKU #	Wt.			MSRP	
10 LBS PER BOX	Platinum		94500580	10	Requires With Media Filler Kit Round: 4 Boxes Square: 4 Boxes	\$114	
	Bronze		94500581	10		\$114	
	Cobalt		94500582	10		Without Media Filler Kit Round: 8 Boxes Square: 10 Boxes	\$114
	Black		94500583	10		\$114	
With Media Filler Kit Uses Round: 35 lbs Square: 35 lbs Without Media Filler Kit Uses Round: 75 lbs Square: 95 lbs	Tumbled Stones		94500985	11	Requires Round: 4 Boxes Square: 6 Boxes AND Requires Round: 2 Boxes Square: 3 Boxes	\$74	
	Uses Small Round: 40 lbs Square: 60 lbs AND Uses Large Round: 40 lbs Square: 60 lbs	10 lbs Small Rock 20 lbs Large Rock	94500986	21		\$116	



18" Voracious Fire™ Burner

Model	SKU #	Wt. Lbs							MSRP
18" Voracious Fire™ Burner 175,000 BTUs NG Includes stainless steel burner, 1/4" thick aluminum plate base, 2 air vents, key valve kit (shut off), Z bracket, 24V AC Hot Shot™ electronic ignition (patent pending) and LP conversion kit. 	94900342	44							\$1,840

STEP #1 - SELECT A SINGLE MODEL OR MULTIPLE MODEL TRANSFORMER

Required	SKU #	Wt.					MSRP
Single Model Transformer Has single 24v lead up to 95ft. Can run 1 Fire Garden™ Product. 	94800833	5					\$184
Multiple Model Transformer Has 24V/26V/28V leads. Can run up to six Fire Garden™ Products. Transformer can be located up to 1000ft. from single unit, or approximately 100ft from group of six units. 	94800830	15					\$292



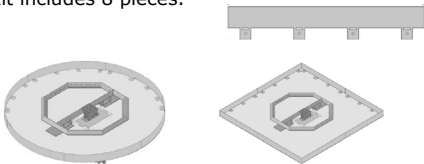



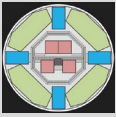

STEP #2 - SELECT A ROUND, SQUARE OR CUSTOM PLATE KIT

Required	SKU #	Wt.				MSRP
33" Round Plate Kit 	94601220	14				\$380
33" Square Plate Kit 	94601221	20				\$418
Custom Plate Kit over 35"	94601222				COST BY BID	
Notable Extra	SKU #	Wt.				MSRP
Pan Kit -Converts Plate to a Pan This optional kit adds a 2" high lip to the perimeter of the burner plate to contain the media. Each Kit includes 8 pieces. 	94601201	3		Requires Round or Square 1 Kit		\$104



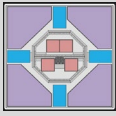

18" Voracious Fire™ Burner

STEP #3 - SELECT MEDIA FILLER KIT FOR CRUSHED GLASS ONLY

This Kit provides aluminum filler shapes to take up some of the empty space around the burner thereby reducing the amount of glass media that is needed to cover the firepit bottom plate and cover the burner. The filler pieces are shipped flat and must be hand bent into shape before being installed in the firepit.

FOR ROUND PLATE Requires: 1 of Kit 'A' 1 of Kit 'B' 1 of Kit 'D'			SKU #	Wt.			MSRP
Filler Piece Shape 'A' Each Kit includes 4 pieces		94601241	1	Requires 1 Kit			\$58
Filler Piece Shape 'B' Each Kit includes 4 pieces		94601242	1	Requires 1 Kit			\$64
Filler Piece Shape 'D' Each Kit includes 4 pieces		94601244	4	Requires 1 Kit			\$96
FOR SQUARE PLATE Requires: 1 of Kit 'A' 1 of Kit 'B' 1 of Kit 'C'			SKU #	Wt.			MSRP
Filler Piece Shape 'A' Each Kit includes 4 pieces		94601241	1	Requires 1 Kit			\$58
Filler Piece Shape 'B' Each Kit includes 4 pieces		94601242	1	Requires 1 Kit			\$64
Filler Piece Shape 'C' Each Kit includes 4 pieces		94601243	5	Requires 1 Kit			\$116



STEP #4 - SELECT A CRUSHED GLASS COLOR OR TUMBLED STONES

Required		SKU #	Wt.			MSRP
10 LBS PER BOX With Media Filler Kit Uses Round: 60 lbs Square: 65 lbs Without Media Filler Kit Uses Round: 105 lbs Square: 130 lbs	Platinum		94500580	10	Requires With Media Filler Kit Round: 6 Boxes Square: 7 Boxes Without Media Filler Kit Round: 11 Boxes Square: 13 Boxes	\$114
	Bronze		94500581	10		\$114
	Cobalt		94500582	10		\$114
	Black		94500583	10		\$114
Uses Small Round: 50 lbs Square: 70 lbs AND Uses Large Round: 60 lbs Square: 100 lbs	Tumbled Stones		94500985	11	Requires Round: 5 Boxes Square: 7 Boxes AND Requires Round: 3 Boxes Square: 5 Boxes	\$74
			94500986	21		\$116



22" Voracious Fire™ Burner

Model	SKU #	Wt. Lbs							MSRP
22" Voracious Fire™ Burner 225,000 BTUs NG Includes stainless steel burner, 1/4" thick aluminum plate base, 2 air vents, key valve kit (shut off), Z bracket, 24V AC Hot Shot™ electronic ignition (patent pending) and LP conversion kit. 	94900343	68							\$1,956

STEP #1 - SELECT A SINGLE MODEL OR MULTIPLE MODEL TRANSFORMER

Required	SKU #	Wt.					MSRP
Single Model Transformer Has single 24v lead up to 95ft. Can run 1 Fire Garden™ Product. 	94800833	5					\$184
Multiple Model Transformer Has 24V/26V/28V leads. Can run up to six Fire Garden™ Products. Transformer can be located up to 1000ft. from single unit, or approximately 100ft from group of six units. 	94800830	15					\$292



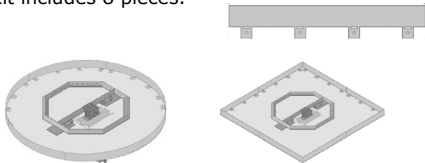



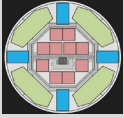

STEP #2 - SELECT A ROUND, SQUARE OR CUSTOM PLATE KIT

Required	SKU #	Wt.				MSRP
37" Round Plate Kit 	94601225	20				\$468
37" Square Plate Kit 	94601226	27				\$506
Custom Plate Kit over 39"	94601227		COST BY BID			
Notable Extra	SKU #	Wt.				MSRP
Pan Kit -Converts Plate to a Pan This optional kit adds a 2" high lip to the perimeter of the burner plate to contain the media. Each Kit includes 8 pieces. 	94601201	3	Requires Round or Square 1 Kit			\$104



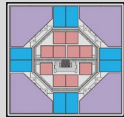

22" Voracious Fire™ Burner

STEP #3 - SELECT MEDIA FILLER KIT FOR CRUSHED GLASS ONLY

This Kit provides aluminum filler shapes to take up some of the empty space around the burner thereby reducing the amount of glass media that is needed to cover the firepit bottom plate and cover the burner. The filler pieces are shipped flat and must be hand bent into shape before being installed in the firepit.

FOR ROUND PLATE			SKU #	Wt.			MSRP
Requires: 3 of Kit 'A' 1 of Kit 'B' 1 of Kit 'D'							
Filler Piece Shape 'A'		94601241	1	Requires 3 Kits			\$58
Each Kit includes 4 pieces							
Filler Piece Shape 'B'		94601242	1	Requires 1 Kit			\$64
Each Kit includes 4 pieces							
Filler Piece Shape 'D'		94601244	4	Requires 1 Kit			\$96
Each Kit includes 4 pieces							
FOR SQUARE PLATE			SKU #	Wt.			MSRP
Requires: 3 of Kit 'A' 2 of Kit 'B' 1 of Kit 'C'							
Filler Piece Shape 'A'		94601241	1	Requires 3 Kits			\$58
Each Kit includes 4 pieces							
Filler Piece Shape 'B'		94601242	1	Requires 2 Kits			\$64
Each Kit includes 4 pieces							
Filler Piece Shape 'C'		94601243	5	Requires 1 Kit			\$116
Each Kit includes 4 pieces							



STEP #4 - SELECT A CRUSHED GLASS COLOR OR TUMBLED STONES

Required		SKU #	Wt.			MSRP
10 LBS PER BOX With Media Filler Kit Uses Round: 70 lbs Square: 70 lbs Without Media Filler Kit Uses Round: 130 lbs Square: 160 lbs	Platinum		94500580	10	Requires With Media Filler Kit Round: 7 Boxes Square: 7 Boxes Without Media Filler Kit Round: 13 Boxes Square: 16 Boxes	\$114
	Bronze		94500581	10		\$114
	Cobalt		94500582	10		\$114
	Black		94500583	10		\$114
Uses Small Round: 60 lbs Square: 80 lbs AND Uses Large Round: 100 lbs Square: 140 lbs	Tumbled Stones		94500985	11	Requires Round: 6 Boxes Square: 8 Boxes AND Requires Round: 5 Boxes Square: 7 Boxes	\$74
			94500986	21		\$116

32" Voracious Fire™ Burner

Model	SKU #	Wt. Lbs							MSRP
32" Voracious Fire™ Burner 350,000 BTUs NG Includes stainless steel burner, 1/4" thick aluminum plate base, 2 air vents, key valve kit (shut off), Z bracket, 24V AC Hot Shot™ electronic ignition (patent pending) and LP conversion kit. 	94900344	102							\$2,600

STEP #1 - SELECT A SINGLE MODEL OR MULTIPLE MODEL TRANSFORMER

Required	SKU #	Wt.					MSRP
Single Model Transformer Has single 24v lead up to 95ft. Can run 1 Fire Garden™ Product. 	94800833	5					\$184
Multiple Model Transformer Has 24V/26V/28V leads. Can run up to six Fire Garden™ Products. Transformer can be located up to 1000ft. from single unit, or approximately 100ft from group of six units. 	94800830	15					\$292



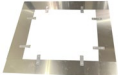
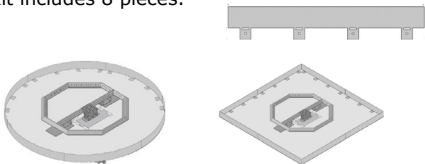

STEP #2 - SELECT A ROUND, SQUARE OR CUSTOM PLATE KIT

Required	SKU #	Wt.				MSRP
47" Round Plate Kit 	94601230	24				\$570
47" Square Plate Kit 	94601231	35				\$608
Custom Plate Kit over 49"	94601232				COST BY BID	
Notable Extra	SKU #	Wt.				MSRP
Pan Kit -Converts Plate to a Pan This optional kit adds a 2" high lip to the perimeter of the burner plate to contain the media. Each Kit includes 8 pieces. 	94601201	3		Requires Round: 1 Kit Square: 2 Kits		\$104

32" Voracious Fire™ Burner

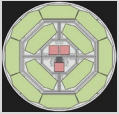
STEP #3 - SELECT MEDIA FILLER KIT FOR CRUSHED GLASS ONLY

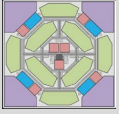

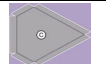
This Kit provides aluminum filler shapes to take up some of the empty space around the burner thereby reducing the amount of glass media that is needed to cover the firepit bottom plate and cover the burner. The filler pieces are shipped flat and must be hand bent into shape before being installed in the firepit.

FOR ROUND PLATE			SKU #	Wt.			MSRP
Requires: 1 of Kit 'A' 3 of Kit 'D'							
Filler Piece Shape 'A'		94601241	1	Requires 1 Kit			\$58
Filler Piece Shape 'D'		94601244	4	Requires 3 Kits			\$96
FOR SQUARE PLATE			SKU #	Wt.			MSRP
Requires: 2 of Kit 'A' 1 of Kit 'B' 1 of Kit 'C' 2 of Kit 'D'							
Filler Piece Shape 'A'		94601241	1	Requires 2 Kits			\$58
Filler Piece Shape 'B'		94601242	1	Requires 1 Kit			\$64
Filler Piece Shape 'C'		94601243	5	Requires 1 Kit			\$116
Filler Piece Shape 'D'		94601244	4	Requires 2 Kits			\$96



STEP #4 - SELECT A CRUSHED GLASS COLOR OR TUMBLED STONES

Required		SKU #	Wt.			MSRP
10 LBS PER BOX With Media Filler Kit Uses Round: 100 lbs Square: 110 lbs Without Media Filler Kit Uses Round: 210 lbs Square: 260 lbs	Platinum		94500580	10	Requires With Media Filler Kit Round: 10 Boxes Square: 11 Boxes Without Media Filler Kit Round: 21 Boxes Square: 26 Boxes	\$114
	Bronze		94500581	10		\$114
	Cobalt		94500582	10		\$114
	Black		94500583	10		\$114
Uses Small Round: 70 lbs Square: 100 lbs AND Uses Large Round: 160 lbs Square: 220 lbs	Tumbled Stones		94500985	11	Requires Round: 7 Boxes Square: 10 Boxes AND Requires Round: 8 Boxes Square: 11 Boxes	\$74
			94500986	21		\$116

Tempest 20K Torches™





Model	SKU #	Wt. Lbs							MSRP
TEMPEST TORCH HEAD ASSEMBLIES - REQUIRE MOUNTING EQUIPMENT									
Tempest Torch - Piezo Igniter 20K BTUs. Includes manual igniter head assembly, tempered glass and removable rain cap.									
		NG 94900743 26							\$1,096
		LP 94900753 26							\$1,096
Tempest 24v Torch - Electronic Ignition 20K BTUs. Includes electric igniter head assembly, 24V AC Hot Shot™ electronic ignition(patent pending), tempered glass, removable rain cap, control module, shutoff valve, and flare reducing coupler. Requires 110-24v transformer.									
		NG 94900745 29						\$1,834	
		LP 94900755 30							\$1,834

STEP #1 - SELECT A SINGLE MODEL OR MULTIPLE MODEL TRANSFORMER

Required	SKU #	Wt.					MSRP
Single Model Transformer Has single 24v lead up to 95ft. Can run 1 Fire Garden™ Product.		94800833	5				\$184
Multiple Model Transformer Has 24V/26V/28V leads. Can run up to six Fire Garden™ Products. Transformer can be located up to 1000ft. from single unit, or approximately 100ft from group of six units.							
		94800830	15				\$292

Tempest 20K Torches™



STEP #2 - CHOOSE A WAY TO MOUNT THE TEMPEST TORCH HEAD ASSEMBLY

Required	SKU #	Wt.			MSRP
<p>Posts, Black</p>  <p>In Ground - 3"x93" Includes 1/2" flex</p> <p>Deck - 3"x69" Includes 1/2" flex</p> <p>Deck Mount 13" diam x 5" H</p>	94800813	16			\$288
	94800812	12			\$274
	94800821	12			\$218
<p>Post Cover, Square Black For Deck Mount. Decorative base. 13" sq. x 6" H</p> 	94800827	8			\$192
<p>Pillar Mount, Black 3" x 11" - Allows installation on raised pillar or pedestal.</p> 	94800826	3			\$192
<p>Wall Mount, Black Includes 1/2" flex</p> 	94800825	14			\$394

Tempest 20K Lanterns™





Model	SKU #	Wt. Lbs							MSRP
TEMPEST LANTERN HEAD ASSEMBLIES - REQUIRE MOUNTING EQUIPMENT									
Tempest Lantern - Piezo Igniter 20K BTUs. 22 1/2" x 9 1/2". Includes manual igniter head and tempered glass.		NG 94900746 32							\$1,454
		LP 94900756 32							\$1,454
Tempest 24v Lantern - Electronic Ignition 20K BTUs. 22 1/2" x 9 1/2". Includes electronic igniter head assembly, 24V AC Hot Shot™ electronic ignition(patent pending), tempered glass, control module, shutoff valve, and flare reducing coupler. Requires 110-24v transformer.		NG 94900747 31							\$2,080
		LP 94900757 31						SOLD OUT!	\$2,080

STEP #1 - SELECT A SINGLE MODEL OR MULTIPLE MODEL TRANSFORMER

Required	SKU #	Wt.					MSRP
Single Model Transformer Has single 24v lead up to 95ft. Can run 1 Fire Garden™ Product.		94800833	5				\$184
Multiple Model Transformer Has 24V/26V/28V leads. Can run up to six Fire Garden™ Products. Transformer can be located up to 1000ft. from single unit, or approximately 100ft from group of six units.							
		94800830	15				



Tempest 20K Lanterns™

STEP #2 - CHOOSE A WAY TO MOUNT THE TEMPEST TORCH HEAD ASSEMBLY







Required	SKU #	Wt.			MSRP
Posts, Black  <p>In Ground - 3"x93" Includes 1/2" flex</p> <p>Deck - 3"x69" Includes 1/2" flex</p> <p>Deck Mount 13" diam x 5" H</p>	94800813	16			\$288
	94800812	12			\$274
	94800821	12			\$218
Post Cover, Square Black For Deck Mount. Decorative base. 13" sq. x 6" H 	94800827	8			\$192
Pillar Mount, Black 3" x 11" - Allows installation on raised pillar or pedestal. 	94800826	3			\$192
Wall Mount, Black Includes 1/2" flex 	94800831	14			\$432

Model	SKU #	Wt. Lbs							MSRP
TEMPEST LANTERN HEAD ASSEMBLIES - REQUIRE MOUNTING EQUIPMENT									
<p>Tempest 24v Lantern - Electronic Ignition 50K BTUs. 33 1/8" x 11" x 11". Includes electronic igniter head assembly, 24V AC Hot Shot™ electronic ignition(patent pending), NG, LP conversion kit, tempered glass, control module, shutoff valve, and flare reducing coupler. Requires 110-24v transformer. Note: LP conversion is 45,000 BTUs</p> 	94900748	48							\$3,382

STEP #1 - SELECT A SINGLE MODEL OR MULTIPLE MODEL TRANSFORMER

Required	SKU #	Wt.					MSRP
<p>Single Model Transformer Has single 24v lead up to 95^{ft}. Can run 1 Fire Garden™ Product.</p> 	94800833	5					\$184
<p>Multiple Model Transformer Has 24V/26V/28V leads. Can run up to six Fire Garden™ Products. Transformer can be located up to 1000^{ft}. from single unit, or approximately 100^{ft} from group of six units.</p> 	94800830	15					\$292

STEP #2 - CHOOSE A WAY TO MOUNT THE TEMPEST TORCH HEAD ASSEMBLY

Required	SKU #	Wt.					MSRP
<p>Posts, Black</p> <p>In Ground - 3"x93" Includes 1/2" flex</p>  <p>Deck - 3"x69" Includes 1/2" flex</p>  <p>Deck Mount 13" diam x 5" H</p> 	94800813	16					\$288
	94800812	12					\$274
	94800821	12					\$218
<p>Post Cover, Square Black For Deck Mount. Decorative base. 13" sq. x 6" H</p> 	94800827	8					\$192
<p>Pillar Mount, Black 3" x 11" - Allows installation on raised pillar or pedestal.</p> 	94800826	3					\$192
<p>Wall Mount, Black Includes 1/2" flex</p> 	94800832	17					\$468



CUSTOM PLATE KIT ORDER FORM - 94601212
10" Voracious Fire Burner-Square, Rectangular or Round

SQUARE OR RECTANGULAR

COST BY BID

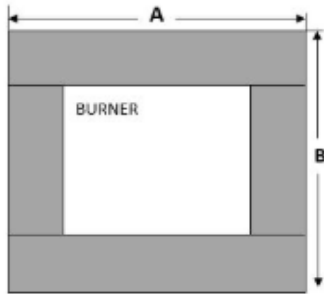

A(Width) = _____ inches
 Standard size – 25"
 B(Depth) = _____ inches
 Standard size – 25"

ADDITIONAL FEES & OPTIONS

- Oversize Fee: (A or B) > 47-3/4"
- Additional Z Bracket Kit (2Pack)

ROUND

COST BY BID

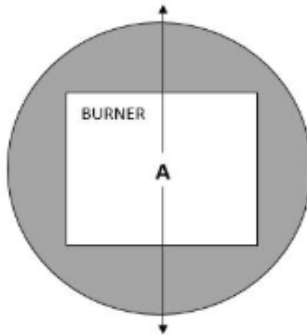

A = _____ inches
 Standard size – 25"

ADDITIONAL FEES & OPTIONS

- Oversize Fee: (A or B) > 47-3/4"
- Additional Z Bracket Kit (2Pack)

Store Name	Ship To Address
Authorized Store Representative (PRINT)	PO #
I Accept Responsibility for the Above Dimensions (SIGN)	Phone
	Date

Note: Custom plate kits may require additional media. Please see media guide.
Cancellation Policy: Cancellations made after 48 hours of submitting the order will be subject to a \$100 cancellation fee. This cancellation policy is in effect to cover the engineering and programming time it takes for each custom plate kit. Custom plate kits that have already been cut may not be cancelled.
 All custom plate kit orders must include a valid P.O. number and will be made to the specifications on this sheet. Travis Industries assumes no liability for any incorrect information provided on the order form. **Allow for a 4-5 week lead-time.** All custom plate kits that ship from outlying warehouses will have longer lead times. If you have questions please contact your sales department at 800-654-1177.

CUSTOM PLATE KIT ORDER FORM - 94601217
13" Voracious Fire Burner-Square, Rectangular or Round



SQUARE OR RECTANGULAR

COST BY BID

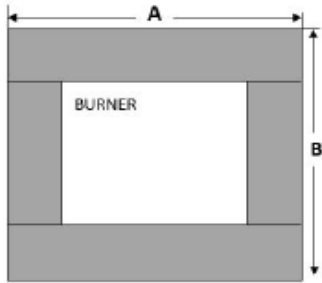

A(Width) = inches
 Standard size – 28"
 B(Depth) = inches
 Standard size – 28"

ADDITIONAL FEES & OPTIONS

- Oversize Fee: (A or B) > 47-3/4"
- Additional Z Bracket Kit (2Pack)

ROUND

COST BY BID

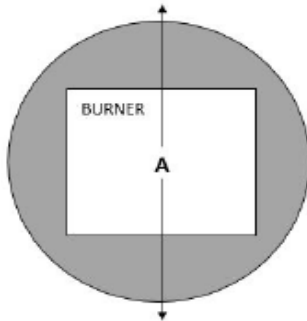

A = inches
 Standard size – 28"

ADDITIONAL FEES & OPTIONS

- Oversize Fee: (A or B) > 47-3/4"
- Additional Z Bracket Kit (2Pack)

<input type="text"/>	<input type="text"/>	
Store Name	Ship To Address	
<input type="text"/>	<input type="text"/>	<input type="text"/>
Authorized Store Representative (PRINT)	PO #	Phone
<input type="text"/>	<input type="text"/>	<input type="text"/>
I Accept Responsibility for the Above Dimensions (SIGN)		Date
<input type="text"/>		<input type="text"/>

Note: Custom plate kits may require additional media. Please see media guide.
 Cancellation Policy: Cancellations made after 48 hours of submitting the order will be subject to a \$100 cancellation fee. This cancellation policy is in effect to cover the engineering and programming time it takes for each custom plate kit. Custom plate kits that have already been cut may not be cancelled.
 All custom plate kit orders must include a valid P.O. number and will be made to the specifications on this sheet. Travis Industries assumes no liability for any incorrect information provided on the order form. Allow for a 4-5 week lead-time. All custom plate kits that ship from outlying warehouses will have longer lead times. If you have questions please contact your sales department at 800-654-1177.

CUSTOM PLATE KIT ORDER FORM - 94601222

18" Voracious Fire Burner-Square, Rectangular or Round



SQUARE OR RECTANGULAR

COST BY BID

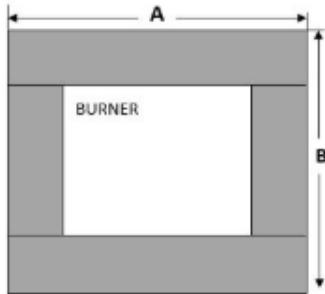

A(Width) = _____ inches

Standard size – 33"

B(Depth) = _____ inches

Standard size – 33"

ADDITIONAL FEES & OPTIONS

Oversize Fee: (A or B) > 47-3/4"

Additional Z Bracket Kit (2Pack)

ROUND

COST BY BID

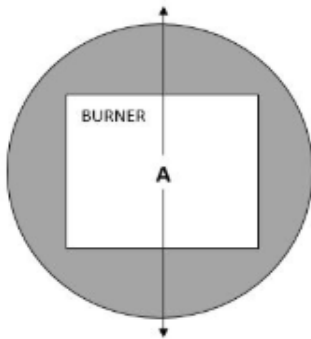

A = _____ inches

Standard size – 33"

ADDITIONAL FEES & OPTIONS

Oversize Fee: (A or B) > 47-3/4"

Additional Z Bracket Kit (2Pack)

Store Name		Ship To Address	
Authorized Store Representative (PRINT)		PO #	Phone
I Accept Responsibility for the Above Dimensions (SIGN)			Date

Note: Custom plate kits may require additional media. Please see media guide.

Cancellation Policy: Cancellations made after 48 hours of submitting the order will be subject to a \$100 cancellation fee. This cancellation policy is in effect to cover the engineering and programming time it takes for each custom plate kit. Custom plate kits that have already been cut may not be cancelled.

All custom plate kit orders must include a valid P.O. number and will be made to the specifications on this sheet. Travis Industries assumes no liability for any incorrect information provided on the order form. **Allow for a 4-5 week lead-time.** All custom plate kits that ship from outlying warehouses will have longer lead times. If you have questions please contact your sales department at 800-654-1177.



CUSTOM PLATE KIT ORDER FORM - 94601227
22" Voracious Fire Burner-Square, Rectangular or Round

SQUARE OR RECTANGULAR

COST BY BID

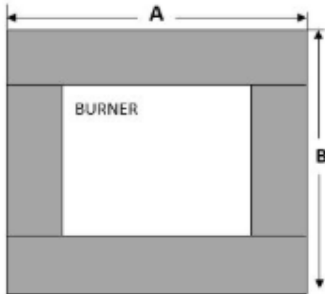

A(Width) = _____ inches
 Standard size – 37"
 B(Depth) = _____ inches
 Standard size – 37"

ADDITIONAL FEES & OPTIONS

- Oversize Fee: (A or B) > 47-3/4"
- Additional Z Bracket Kit (2Pack)

ROUND

COST BY BID

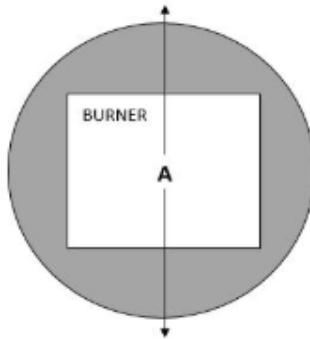

A = _____ inches
 Standard size – 37"

ADDITIONAL FEES & OPTIONS

- Oversize Fee: (A or B) > 47-3/4"
- Additional Z Bracket Kit (2Pack)

Store Name	Ship To Address
Authorized Store Representative (PRINT)	PO #
I Accept Responsibility for the Above Dimensions (SIGN)	Phone
	Date

Note: Custom plate kits may require additional media. Please see media guide.

Cancellation Policy: Cancellations made after 48 hours of submitting the order will be subject to a \$100 cancellation fee. This cancellation policy is in effect to cover the engineering and programming time it takes for each custom plate kit. Custom plate kits that have already been cut may not be cancelled.

All custom plate kit orders must include a valid P.O. number and will be made to the specifications on this sheet. Travis Industries assumes no liability for any incorrect information provided on the order form. **Allow for a 4-5 week lead-time.** All custom plate kits that ship from outlying warehouses will have longer lead times. If you have questions please contact your sales department at 800-654-1177.



CUSTOM PLATE KIT ORDER FORM - 94601232

32" Voracious Fire Burner-Square, Rectangular or Round

SQUARE OR RECTANGULAR

COST BY BID

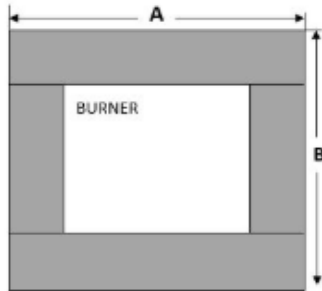

A(Width) = _____ inches
 Standard size - 37"
 B(Depth) = _____ inches
 Standard size - 37"

ADDITIONAL FEES & OPTIONS

- Oversize Fee: (A or B) > 47-3/4" **COST BY BID**
- Additional Z Bracket Kit (2Pack)

ROUND

COST BY BID

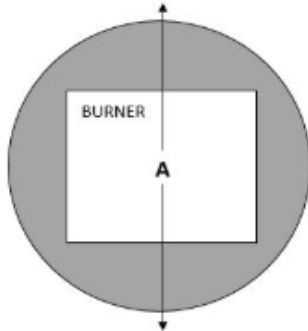

A = _____ inches
 Standard size - 37"

ADDITIONAL FEES & OPTIONS

- Oversize Fee: (A or B) > 47-3/4" **COST BY BID**
- Additional Z Bracket Kit (2Pack)

Store Name	Ship To Address
Authorized Store Representative (PRINT)	PO #
I Accept Responsibility for the Above Dimensions (SIGN)	Phone
	Date

Note: Custom plate kits may require additional media. Please see media guide.

Cancellation Policy: Cancellations made after 48 hours of submitting the order will be subject to a \$100 cancellation fee. This cancellation policy is in effect to cover the engineering and programming time it takes for each custom plate kit. Custom plate kits that have already been cut may not be cancelled.

All custom plate kit orders must include a valid P.O. number and will be made to the specifications on this sheet. Travis Industries assumes no liability for any incorrect information provided on the order form. **Allow for a 4-5 week lead-time.** All custom plate kits that ship from outlying warehouses will have longer lead times. If you have questions please contact your sales department at 800-654-1177.