



Pictured above: The new 24" Rugged Forest Split Log Set (see page 4).

TABLE OF CONTENTS

SECTION	DESCRIPTION	PAGE
I	Standard Gas Log Sets Only - Charred Series, Designer Series & Classic Series	3-5
II	Standard Burner Systems Only - Gas Log Burners and Glass Burners	5-7
III	See-Thru Gas Log Sets Only - Charred Series, Designer Series, and Classic Series	8
IV	See-Thru Burner Systems Only - Gas Log Burners and Glass Burners	8-9
V	Specialty Burner Systems & Gas Logs - G31, G52, and P45 Burner Systems	10-12
VI	Safety Valves and Remote Compatible Options	13
VII	Glass Media & Fyre Spheres - Fyre Glass, Reflective Fyre Glass, Fyre Gems, Diamond Nuggets, and Fyre Spheres	14
VIII	Accessories	14-16

RH PETERSON CO.

14724 Proctor Avenue • City of Industry, CA 91746 • Website: www.rhpeterson.com • Phone (626) 369-5085 • Fax (626) 369-5979

SUPERSEDES ALL OTHER PRICE LISTS • PRICES SUBJECT TO CHANGE WITHOUT NOTICE • ALL PRICES FOB FACTORY, TERMS: NET 30 DAYS

1. Select log style design or contemporary media



Purchase Info. Key

- For all model numbers: **= Insert Size
- All prices: \$
- Weight: #

GAS LOG STYLE CODES

CHARRED SERIES	
GHD:	Charred Oak
HCHR:	Burnt Rustic Oak
CHS:	Charred Split
CHRRSO:	Charred Rugged Split Oak
CHAO:	Charred American Oak
CHN:	Charred Northern Oak
CHB:	Charred Royal English Oak
CHMJ:	Charred Majestic Oak
CHNA:	Charred Angel Oak
CHNS:	Charred Angel Split Oak
CHMBW:	Charred Mountain Birch
ENO:	Charred Evergreen Oak*
ENS:	Charred Evergreen Split Oak*
BTA:	Burnt Aspen*

DESIGNER SERIES	
RDP:	Golden Oak Designer Plus
HRD:	Rustic Oak Designer
AO:	American Oak
S:	Split Oak
SDP:	Split Oak Designer Plus
RRSO:	Rugged Split Oak
WO:	Woodland Oak
MBW:	Mountain Birch
W:	White Birch
BD:	Royal English Oak Designer
GSO:	Gnarled Split Oak
CN:	Chestnut Oak
RFS:	Rugged Forest Split
MCO:	Mountain Crest Oak*
MCS:	Mountain Crest Split Oak*
COLO:	Colonial Oak*

CLASSIC SERIES	
R:	Golden Oak
HR:	Rustic Oak
RRO:	Rugged Oak
PO:	Post Oak
B:	Royal English Oak
CDR:	Coastal Driftwood

See page 8 for See-thru Gas Log Sets

CONTEMPORARY MEDIA CODES

FYRE GLASS	
GL-F:	Azuria
GL-B:	Black
GL-Z:	Bronze
GL-N:	Caribbean Blue
GL-C:	Clear
GL-E:	Emerald
GL-W:	Star Fyre

FYRE GEMS	
GLG-J:	Black Pearl
GLG-T:	Blue Topaz
GLG-D:	Champagne
GLG-A:	Deep Amber
GLG-E:	Emerald
GLG-C:	Glacier
GLG-S:	Sapphire
GLG-RY:	Ruby

REFLECTIVE FYRE GLASS	
GL-FR:	Azuria Reflective
GL-BR:	Black Reflective
GL-ZR:	Bronze Reflective
GL-NR:	Caribbean Blue Reflective
GL-QR:	Copper Reflective
GL-ER:	Emerald Reflective
GL-HR:	Gold Reflective
GL-CR:	Champagne Reflective

DIAMOND NUGGETS	
GLD-C:	Clear
GLD-SB:	Steel Blue
GLD-R:	Rosé
GLD-E:	Emerald
GLD-PB:	Pacific Blue
GLD-DB:	Deep Black

FOR P45 BURNER	
EB:	Epic Black Fyre Spheres*
GS:	Graystone Fyre Spheres*
SO:	Shoreline Designer Oak*
SDW:	Shoreline Driftwood*

See Pages 14 & 15 for FYRE SPHERES & RIVER ROCK

* Log sets are only compatible with specific specialty burners - see Section V.

2. Select burner system



G45-24-02

BURNER STYLE CODES

LISTED BURNERS	
G4:	Glowing Ember
G45:	Triple T Burner
GX45:	Heavy Duty Triple T Burner
G45-GL:	Triple T Glass Burner
PB:	Pan Burner (For Glass)

ANSI CERTIFIED BURNERS	
G45(A):	Triple T Burner
G45(A)-SS:	Triple T Stainless Steel
G45-GL(A):	Triple T Glass Burner
G45-GL-SS:	Triple T Stainless Glass
G46:	Glowing Ember
PB(A):	Pan Burner (For Glass)
P45:	Tapered Pan Burner
G31:	3-Tiered Burner
G52:	Radiant Fyre Burner
G52-SS:	Radiant Fyre Burner Stainless Steel

See pages 8 - 9 for See-thru Burner Systems

3. Select size

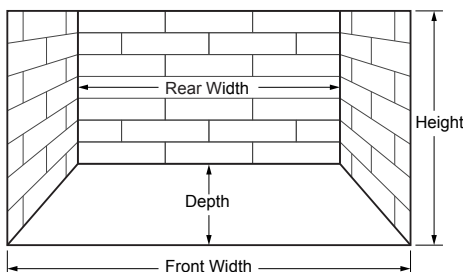

4. Select controls

(Page 13)



APK-15

5. Select accessories

(Pages 15-16)



DP-7 DECOR PACK
Featuring Bryte Coals

A. Charred Series - Standard Gas Log Sets

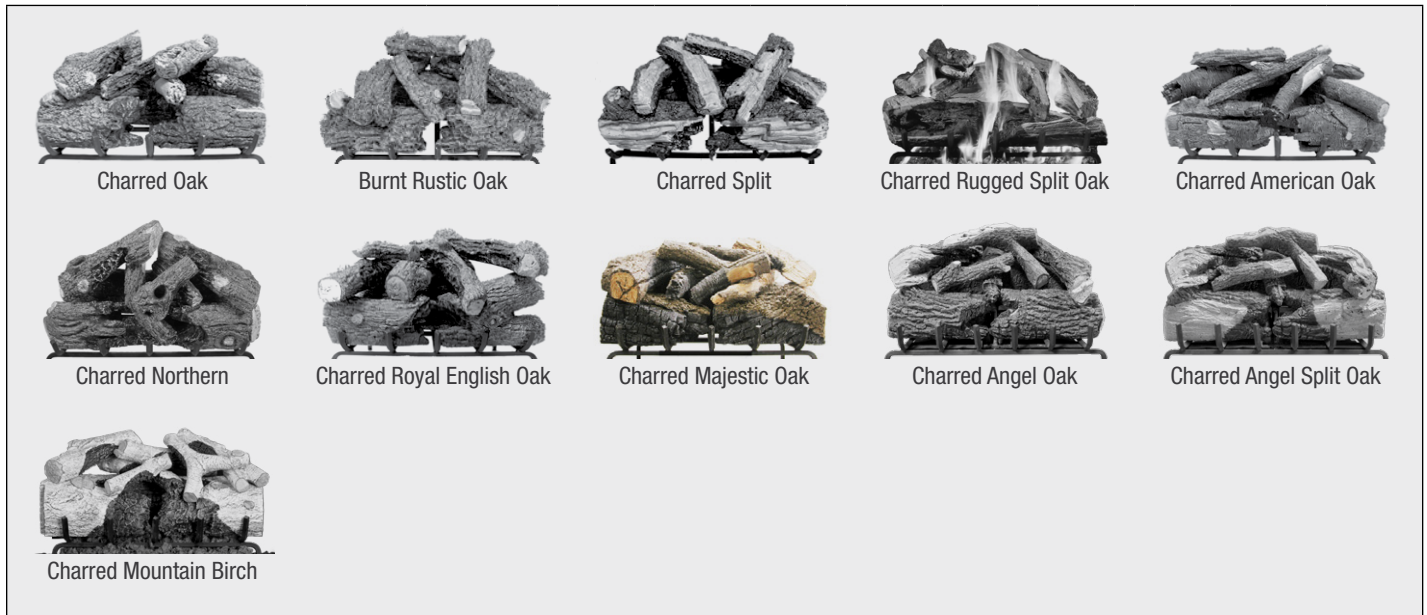

GAS LOG STYLE	BURNER KEY	MODEL #	16"	18/20"	24"	30"	36" *	42" *	48" *	60" *	72" *
Charred Oak	1, 3	CHD-**	\$382 28#/1	\$431 46#/1	\$506 62#/1	\$676 78#/1	--	--	--	--	--
Burnt Rustic Oak	1	HCHR-**	382 28#/1	431 46#/1	506 62#/1	676 80#/1	--	--	--	--	--
Charred Split	1, 3	CHS-**	--	463 42#/1	534 54#/1	710 78#/1	921 116#/2	--	--	--	--
Charred Rugged Split Oak	1	CHRRSO-**	--	493 46#/1	561 57#/1	727 67#/1	--	--	--	--	--
Charred American Oak	1, 3	CHAO-**	--	534 57#/1	609 63#/1	793 82#/2	--	--	--	--	--
Charred Northern	1	CHN-**	--	442 48#/1	523 62#/1	691 76#/1	--	--	--	--	--
Charred Royal English Oak *	2, 3	CHB-**	--	530 52#/1	634 83#/2	812 111#/2	1,034 141#/3	1,347 169#/3	--	--	--
Charred Majestic Oak *	2	CHMJ-**	--	--	720 94#/2	928 119#/2	1,129 156#/3	1,412 172#/3	1,622 300#/1	1,940 340#/1	2,174 430#/1
Charred Angel Oak	1, 3	CHNA-**	--	455 44#/1	523 54#/1	610 64#/1	--	--	--	--	--
Charred Angel Split Oak	1, 3	CHNS-**	--	482 42#/1	548 52#/1	644 62#/1	--	--	--	--	--
Charred Mountain Birch	1, 3	CHMBW-**	--	517 46#/1	589 60#/1	750 76#/1	951 104#/2	1,250 131#/3	--	--	--

* Log set uses **GX45** Burner Kit with Heavy Duty Grate.

BURNER SYSTEM COMPATIBILITY KEY

The following numbers in the Log Style box designate the type of burners that are compatible with each Log Style.

- 1** Compatible with All Gas Log Burner Styles listed on pages 5 - 7 (Listed & ANSI CERTIFIED)
- 2** Compatible with G4, GX4, G45, GX45 and "P" Series Burner Systems (Listed Burners Only)
- 3** Compatible with G31 3-tiered Burner System (See page 11)

B. Designer Series - Standard Gas Log Sets

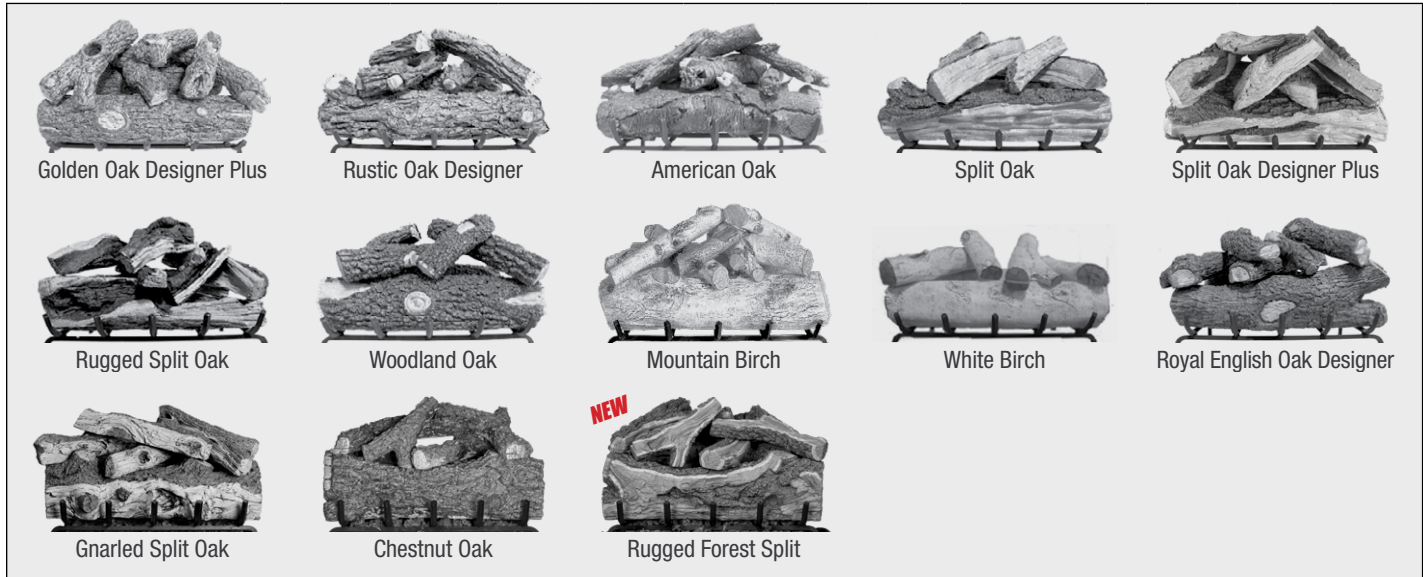

GAS LOG STYLE	BURNER KEY	MODEL #	12"	16"	18"	20"	24"	30"	36"*	42"*	48"*	60"*
Golden Oak Designer Plus	1	RDP-**	\$275 18#/1	\$297 26#/1	\$351 41#/1	\$374 46#/1	\$431 61#/1	\$581 75#/1	\$802 120#/2	\$1,009 187#/3	\$1,230 222#/3	\$1,482 299#/3
Rustic Oak Designer	1	HRD-**	--	298 26#/1	344 41#/1	--	417 61#/1	553 91#/1	806 128#/2	1,013 187#/3	--	--
American Oak	1	AO-**	--	--	474 49#/1	--	548 58#/1	695 77#/2	--	--	--	--
Split Oak	1	S-**	--	--	374 44#/1	397 48#/1	437 65#/1	578 78#/1	--	--	--	--
Split Oak Designer Plus	1	SDP-**	--	--	422 46#/1	457 49#/1	497 67#/1	645 78#/1	850 127#/2	--	--	--
Rugged Split Oak	1	RRSO-**	--	--	457 48#/1	--	521 61#/1	637 65#/1	--	--	--	--
Woodland Oak	1	WO-**	--	--	343 45#/1	354 46#/1	398 60#/1	516 86#/1	--	--	--	--
Mountain Birch	1	MBW-**	--	--	455 45#/1	--	516 72#/1	625 85#/1	850 115#/2	1,086 175#/3	--	--
White Birch	1	W-**	--	--	392 38#/1	--	438 60#/1	537 89#/1	--	--	--	--
Royal English Oak Designer *	2	BD-**	--	--	481 49#/1	--	577 87#/2	726 126#/2	923 152#/3	1,156 184#/3	--	--
Gnarled Split Oak	1	GSO-**	--	--	--	--	693 60#/1	879 95#/2	1,088 130#/3	--	--	--
Chestnut Oak	1	CN-**	--	--	484 43#/1	--	581 66#/1	752 104#/2	951 152#/3	--	--	--
NEW Rugged Forest Split	1	RFS-**	--	--	479 48#/1	--	551 68#/1	709 95#/2	901 146#/3	--	--	--

* Log set uses **GX45** Burner Kit with Heavy Duty Grate.

BURNER SYSTEM COMPATIBILITY KEY

The following numbers in the Log Style box designate the type of burners that are compatible with each Log Style.

- 1** Compatible with All Gas Log Burner Styles listed on pages 5 - 7 (Listed & ANSI CERTIFIED)
- 2** Compatible with G4, GX4, G45, GX45 and "P" Series Burner Systems (Listed Burners Only)
- 3** Compatible with G31 3-tiered Burner System (See page 11)

I Standard Vented Gas Logs Only



2024

C. Classic Series - Standard Gas Log Sets



GAS LOG STYLE	BURNER KEY	MODEL #	12"	16"	18"	20"	24"	30"	36"*	42"*
Golden Oak	1	R-**	\$190 18#/1	\$204 26#/1	\$226 41#/1	\$237 45#/1	\$252 58#/1	\$316 89#/1	\$491 120#/2	\$731 187#/3
Rustic Oak	1	HR-**	--	205 26#/1	227 41#/1	--	253 58#/1	317 94#/1	493 128#/2	735 187#/3
Rugged Oak	1	RR0-**	--	--	283 48#/1	--	339 61#/1	418 68#/1	--	--
Post Oak	1	PO-**	--	--	212 45#/1	224 46#/1	241 60#/1	303 86#/1	--	--
Royal English Oak *	2	B-**	--	--	307 49#/1	--	382 87#/2	473 126#/2	608 152#/3	809 184#/3
Coastal Driftwood	2	CDR-**	--	--	256 44#/1	--	287 56#/1	352 57#/1	501 81#/2	--

* Log set uses **GX4** or **GX45** Burner Kit with Heavy Duty Grate.

II Standard Vented Burners Only



2024

A. G4 Series Listed Burner Systems



DESCRIPTION	MODEL #	12"	16"	18/20"	24"	30"
Glowing Ember Burner System	G4-**	\$261 23#	\$281 24#	\$288 25#	\$303 29#	\$356 35#

Shipped for use with Natural Gas - Specify if for Propane Gas by adding a "P" to the model number (e.g. G4-24P), and add \$222 for required SPK-26.

B. G45 Series Listed Burner Systems - Standard & Glass



DESCRIPTION	MODEL #	16"	18/20"	24"	30"	36"*	42"*	48"*	60"*
Triple T Burner System	G45-**	\$327 25#	\$338 27#	\$366 31#	\$429 37#	\$587 54#	\$827 82#	\$907 97#	\$985 120#
Triple T Burner System (with Heavy Duty Grate)	GX45-**	--	374 31#	403 36#	472 43#	--	--	--	--
Triple T Burner System (for use with Glass Media)†	G45-GL-**	304 20#	314 22#	337 23#	412 31#	553 45#	922 70#	865 80#	941 100#

Shipped for use with Natural Gas - Specify if for Propane Gas by adding a "P" to the model number (e.g. G45-24P), and add \$222 for required SPK-26.

G4 & G45 Burner Systems are Listed up to 30" and include:

Burner, Custom Grate, Glowing Embers, Sand (NG) or Vermiculite (LP), Burner Stabilizing Clips, Flex Connector Kit, & Damper Clamp.

* (-GL) Burners include Stainless Glass Screen and Do Not Include Custom Grate or Glowing Embers. † See page 14 for Glass Media options.

C. G45 Series Triple T Outdoor Burner Systems (-02 Valve) - with S.S. Burner Pan

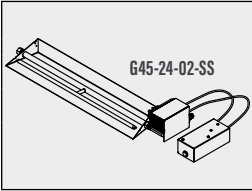

DESCRIPTION	MODEL #	16"	18/20"	24"	30"	36"*	42"*‡	48"*‡	60"*‡
Assembled G45 Outdoor Burner System with "02" Electronic Safety Valve & Remote	G45-**-02-SS	\$1,434 28#	\$1,457 31#	\$1,488 35#	\$1,565 41#	\$1,736 56#	--	--	--
	G45-GL-**-02-SS (for Glass Media)†	1,411 23#	1,433 26#	1,460 27#	1,532 35#	1,701 45#	--	--	--

Shipped for use with Natural Gas - Specify if for propane gas by adding a "P" to the model number (e.g. G45-24-02P-SS). Remote systems include basic Transmitter and Receiver.

* Burner includes Heavy Duty Grate (36" and larger).

D. G45 Series ANSI Certified Triple T Burner Systems - Standard & Glass

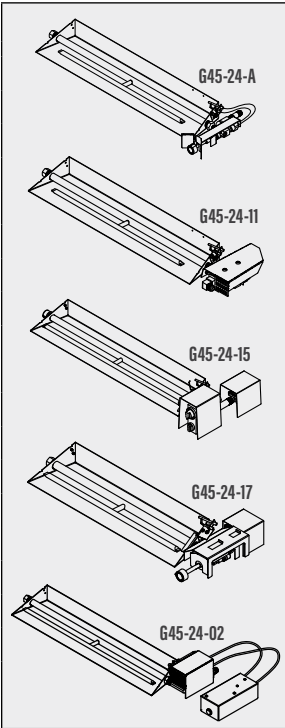

DESCRIPTION	MODEL #	16"	18/20"	24"	30"	36"*
Assembled G45 Burner System with Safety Valve	G45-**-A	\$677 26#	\$687 28#	\$716 32#	\$783 38#	\$942 58#
	G45-GL-**-A (for Glass Media)†	654 21#	663 23#	686 24#	749 32#	907 47#
Assembled G45 Burner System with "11" Series Safety Valve & ON/OFF Remote	G45-**-11	1,113 27#	1,123 29#	1,152 33#	1,219 39#	1,378 54#
	G45-GL-**-11 (for Glass Media)†	1,090 22#	1,099 24#	1,122 25#	1,185 33#	1,343 43#
Assembled G45 Burner System with "15" Series Safety Valve & Variable Remote	G45-**-15	1,184 27#	1,194 29#	1,223 33#	1,290 39#	1,449 54#
	G45-GL-**-15 (for Glass Media)†	1,161 22#	1,170 24#	1,193 25#	1,256 33#	1,414 43#
Assembled G45 Burner System with "17" Series Safety Valve & Variable Remote	G45-**-17	1,021 27#	1,031 29#	1,060 33#	1,127 39#	1,286 54#
	G45-GL-**-17 (for Glass Media)†	998 22#	1,007 24#	1,030 25#	1,093 33#	1,251 43#
Assembled G45 Burner System with "02" Electronic Safety Valve & Remote	G45-**-02	1,341 28#	1,351 31#	1,380 35#	1,447 41#	1,606 56#
	G45-GL-**-02 (for Glass Media)†	1,318 23#	1,327 26#	1,350 27#	1,413 35#	1,571 45#

Shipped for use with Natural Gas - Specify if for Propane Gas by adding a "P" to the model number (e.g. G45-24-11P).

* Burner includes Heavy Duty Grate.

E. G45 Series ANSI Certified Triple T Outdoor Burner Systems - with S.S. Burner Pan



DESCRIPTION	MODEL #	16"	18/20"	24"	30"	36"*	42"*‡	48"*‡	60"*‡
Outdoor Triple T Burner System (Nat. Gas only)	G45-**-SS	\$416 25#	\$439 27#	\$470 31#	\$541 37#	\$704 56#	\$946 87#	\$1,032 97#	\$1,125 120#
	G45-GL-**-SS (for Glass Media)†	394 20#	415 22#	441 23#	510 31#	671 45#	907 70#	989 80#	1,083 100#
Assembled G45 Outdoor Burner System with Safety Valve	G45-**-NA-SS	789 26#	812 28#	843 32#	914 38#	1,077 58#	1,319 89#	1,405 99#	1,498 122#
	G45-GL-**-NA-SS (for Glass Media)†	767 21#	788 23#	814 24#	883 32#	1,044 47#	1,280 72#	1,362 82#	1,456 102#

Shipped for use with Natural Gas - Specify if for propane gas by adding a "P" to the model number (e.g. G45-24-PA-SS).

* Burner includes Heavy Duty Grate (36" and larger).

‡ Sizes 42" - 60" are not certified & are not regulated.

† Glass burners do not include grate or embers. For Glass Media Options see page 14.



F. G46 Series ANSI Certified Burner Systems

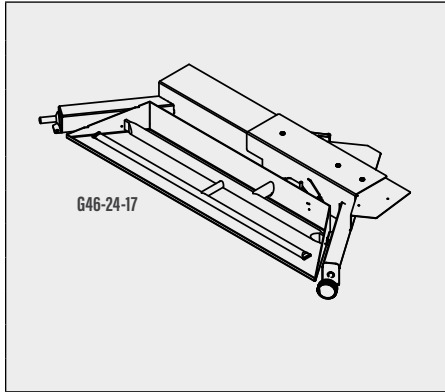

DESCRIPTION	MODEL #	18/20"	24"	30"
G46 Burner System with Safety Pilot Kit	G46-**	\$711 20#	\$746 23#	\$788 28#
G46 Burner System with "11" Series Valve & ON/OFF Remote	G46-**-11	1,161 21#	1,196 24#	1,238 28#
G46 Burner System with "15" Series Valve & Variable Remote	G46-**-15	1,233 21#	1,268 24#	1,310 28#
G46 Burner System with "17" Series Valve & Variable Remote	G46-**-17	1,066 21#	1,101 24#	1,143 28#
G46 Burner System with "O2" Electronic Valve & Remote	G46-**-02	1,357 21#	1,392 24#	1,434 28#

G46 ANSI Certified Burner Systems include: ANSI Certified Burner with Pre-assembled Control Valve & Regulator, Piezo Igniter, Custom Grate, Glowing Embers, Sand (NG) or Vermiculite (LP), Connector Kit, Log Locators, & Damper Clamp. Remote systems include basic Transmitter and Receiver.

Shipped for use with Natural Gas. Specify if for Propane Gas by adding a "P" to the model number (e.g. G46-24-11**P**).

G. PB Series Listed Flame Pan Burner Systems

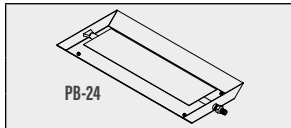

DESCRIPTION	MODEL #	16"	18"	20"	24"	30"	36"	42"
Glass Pan Burner System †	PB-**	\$267 20#	\$277 22#	\$282 24#	\$287 28#	\$337 35#	\$482 40#	\$703 45#

PB Series Glass Burner Systems Include: Pan Burner Assembly, Connector Kit, Sand (NG) or Vermiculite (LP), and Damper Clamp.

Shipped for use with Natural Gas - Specify if for Propane Gas by adding a "P" to the model number (e.g. PB-24**P**), and add **\$222** for required **SPK-26**.

Log Kit = For using logs on **PB** burners, includes log rests and legs. Part #: **PB-LEG-KIT**; Price: **\$133**.

H. PB Series ANSI Certified Flame Pan Glass Burner System

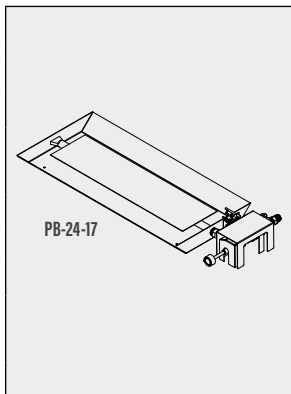

DESCRIPTION	MODEL #	18/20"	24"	30"
Assembled Glass Pan Burner with Safety Valve †	PB-**-A	\$624 25#	\$637 31#	\$686 38#
Assembled Glass Pan Burner with "11" Series Valve & ON/OFF Remote †	PB-**-11	1,059 29#	1,072 34#	1,121 41#
Assembled Glass Pan Burner with "15" Series Valve & Variable Remote †	PB-**-15	1,131 29#	1,144 34#	1,193 41#
Assembled Glass Pan Burner with "17" Series Valve & Variable Remote †	PB-**-17	969 27#	982 32#	1,031 39#
Assembled Glass Pan Burner with "O2" Electronic Valve & Remote †	PB-**-02	1,285 29#	1,298 34#	1,347 41#

Shipped for use with Natural Gas - Specify if for Propane Gas by adding a "P" to the model number (e.g. PB-24-11**P**).

† Glass burners do not include grate or embers. For Glass Media Options see page 14.

III See-Thru Log Sets Only



2024

A. Charred Series • See-Thru Gas Log Sets

DESCRIPTION	MODEL #	16"	18/20"	20"	24"	30"	36"	42"	48"	60"
Charred Oak	CHD-2-**	\$458 30#/1	\$516 48#/1	--	\$602 62#/1	\$780 84#/1	--	--	--	--
Charred Rugged Split Oak	CHRRSO-2-**	--	573 48#/1	--	677 59#/1	834 74#/1	--	--	--	--
Charred American Oak	CHAO-2-**	--	623 62#/1	--	723 77#/1	912 95#/2	--	--	--	--
Charred Royal English Oak (uses GX45-2-** burner w/ heavy duty grate)	CHB-2-**	--	643 52#/1	--	743 83#/2	930 111#/2	1,145 141#/3	1,486 169#/3	--	--

B. Designer Series • See-Thru Gas Log Sets

DESCRIPTION	MODEL #	16"	18"	20"	24"	30"	36"	42"	48"	60"
Golden Oak Designer Plus	RDP-2-**	\$336 24#/1	\$398 46#/1	\$425 49#/1	\$519 71#/1	\$672 86#/1	\$960 137#/3	\$1,042 194#/3	\$1,311 229#/3	\$1,533 305#/3
American Oak	AO-2-**	--	534 55#/1	--	623 62#/1	791 85#/2	--	--	--	--
Split Oak Designer Plus	SDP-2-**	--	491 46#/1	523 49#/1	578 70#/1	746 83#/1	1,004 129#/3	--	--	--
Rugged Split Oak	RRSO-2-**	--	521 53#/1	--	595 67#/1	723 76#/1	--	--	--	--
Mountain Birch	MBW-2-**	--	529 53#/1	--	578 80#/1	703 91#/1	--	--	--	--

C. Classic Series • See-Thru Gas Log Sets

DESCRIPTION	MODEL #	16"	18"	20"	24"	30"	36"	42"	48"	60"
Golden Oak	R-2-**	\$238 27#/1	\$260 46#/1	\$276 48#/1	\$293 68#/1	\$370 97#/1	\$583 137#/3	\$834 194#/3	--	--
Coastal Driftwood	CDR-2-**	--	304 46#/1	--	333 65#/1	418 75#/1	623 100#/3	--	--	--

IV See-Thru Burners Only



2024

A. G45 Series See-Thru Listed Triple T Burner Systems - Standard & Glass



DESCRIPTION	MODEL #	16"	18/20"	24"	30"	36"*	42"*	48"*	60"*
Triple T Burner System	G45-2-**	\$393 40#	\$408 43#	\$441 50#	\$513 61#	\$778 82#	\$1,038 90#	\$1,123 105#	\$1,258 140#
Triple T Burner System (with Heavy Duty Grate)	GX45-2-**	--	465 43#	506 61#	588 79#	--	--	--	--
Triple T Burner System †	G45-2-GL-**	368 35#	383 38#	409 41#	478 53#	743 70#	997 80#	1,077 95#	1,211 120#

Shipped for use with Natural Gas - Specify if for Propane Gas by adding a "P" to the model number (e.g. G45-2-24P), and add \$222 for required SPK-26.

* Burner includes Heavy Duty Grate (36" and larger).

† Glass burners do not include grate or embers. For Glass Media Options see page 14.

B. G45 See-Thru Triple T Outdoor Burner Systems (-02 Valve) - w/ S.S. Burner Pan

DESCRIPTION	MODEL #	16"	18/20"	24"	30"	36"*	42"**	48"**	60"**
Assembled G45 Outdoor Burner w/ "02" Series Electronic Valve & Remote	G45-2-**-02-SS	\$1,512 44#	\$1,552 47#	\$1,602 54#	\$1,685 65#	\$1,969 86#	--	--	--
	G45-2-GL-**-02-SS (for Glass Media)†	1,487 39#	1,525 42#	1,570 45#	1,650 55#	1,935 74#	--	--	--

Shipped for use with Natural Gas - Specify if for propane gas by adding a "P" to the model number (e.g. G45-2-24-02P-SS).
Remote systems include basic Transmitter and Receiver.

* Burner includes Heavy Duty Grate (36" and larger).

C. G45 Series See-Thru ANSI Certified Triple T Burner Systems - Standard & Glass

DESCRIPTION	MODEL #	16"	18/20"	24"	30"	36"*	42"*	48"*	60"*
Assembled G45 Burner with Safety Valve	G45-2-**-A	\$742 42#	\$759 45#	\$789 52#	\$864 63#	\$1,132 84#	--	--	--
	G45-2-GL-**-A (for Glass Media)†	717 37#	733 40#	760 43#	829 53#	1,097 72#	--	--	--
Assembled G45 Burner w/ "11" Series Valve & ON/OFF Remote	G45-2-**-11	1,181 42#	1,198 45#	1,228 52#	1,303 63#	1,571 84#	--	--	--
	G45-2-GL-**-11 (for Glass Media)†	1,156 37#	1,172 40#	1,199 43#	1,268 53#	1,536 72#	--	--	--
Assembled G45 Burner w/ "15" Series Valve & Variable Remote	G45-2-**-15	1,253 42#	1,270 45#	1,300 52#	1,375 63#	1,643 84#	--	--	--
	G45-2-GL-**-15 (for Glass Media)†	1,228 37#	1,244 40#	1,271 43#	1,340 53#	1,608 72#	--	--	--
Assembled G45 Burner w/ "17" Series Valve & Variable Remote	G45-2-**-17	1,090 42#	1,107 45#	1,137 52#	1,212 63#	1,480 84#	--	--	--
	G45-2-GL-**-17 (for Glass Media)†	1,065 37#	1,081 40#	1,108 43#	1,177 53#	1,445 72#	--	--	--
Assembled G45 Burner w/ "02" Series Electronic Valve & Remote	G45-2-**-02	1,413 44#	1,430 47#	1,460 54#	1,535 65#	1,803 86#	--	--	--
	G45-2-GL-**-02 (for Glass Media)†	1,388 39#	1,404 42#	1,431 45#	1,500 55#	1,768 74#	--	--	--

Shipped for use with Natural Gas - Specify if for Propane Gas by adding a "P" to the model number (e.g. G45-2-24-11P).
Remote systems include basic Transmitter and Receiver.

* Burner includes Heavy Duty Grate (36" and larger).

D. G45 See-Thru ANSI Certified Triple T Outdoor Burner Systems - w/ S.S. Burner Pan

DESCRIPTION	MODEL #	16"	18/20"	24"	30"	36"*	42"**	48"**	60"**
Outdoor Triple T Burner System w/ Stainless Steel Burner Pan (Natural Gas only)	G45-2-**-SS	\$488 40#	\$524 45#	\$571 59#	\$651 75#	\$924 82#	\$1,190 90#	\$1,284 105#	\$1,437 140#
	G45-2-GL-**-SS (for Glass Media)†	464 35#	499 40#	541 50#	618 65#	890 70#	1,148 80#	1,239 95#	1,392 120#
Assembled G45 Outdoor Burner with Safety Valve	G45-2-**-NA-SS	866 42#	902 45#	949 52#	1,029 63#	1,302 84#	1,568 92#	1,662 107#	1,815 142#
	G45-2-GL-**-NA-SS (for Glass Media)†	842 37#	877 40#	919 43#	996 53#	1,268 72#	1,526 82#	1,617 97#	1,770 122#

Shipped for use with Natural Gas - Specify if for propane gas by adding a "P" to the model number (e.g. G45-2-24-PA-SS).

* Burner includes Heavy Duty Grate (36" and larger).

† Sizes 42" - 60" are not certified & are not regulated.

† Glass burners do not include grate or embers. For Glass Media Options see page 14.

G31 3-Tiered Burner System & Mountain Crest Style Logs

- Featuring specially designed, hand-crafted **Mountain Crest Oak** & **Mountain Crest Split Oak** Logs.
- **G31 Burner System Includes:** Advanced 3-tiered burner • Porcelainized Reflective Front Panel • Custom grate • Bryte Coals • Glowing Embers • Sand (NG) or Vermiculite (LP) • Connector Kit & Damper Clamp • Choice of pre-assembled Electronic Remote Control, Automatic Variable Control with Remote, pre-assembled Manual Pilot Kit, or Match-Lit System (Natural Gas only).

A. Mountain Crest Gas Logs Only



DESCRIPTION	MODEL #	18"	24"	30"	33"	39"
Mountain Crest Oak	MCO-**	\$450 44#	\$510 52#	\$593 56#	\$648 62#	\$734 68#
Mountain Crest Split Oak	MCS-**	468 42#	533 50#	618 54#	675 60#	763 66#

See page 3 for additional gas log sets compatible with the G31 Burner System (**Burner Key "3"**).

B. G31 3-Tiered Burner System Only



DESCRIPTION	MODEL #	18/20"	24/30"	33/39"
G31 Burner, Match Lit without Valve <i>(Natural Gas only)</i>	G31-**	\$1,247 38#	\$1,302 44#	\$1,472 48#
G31 Burner with Manual Valve and Standing Pilot *	G31-**-A	1,597 40#	1,652 46#	1,822 50#
G31 Burner with Automatic Variable Valve and Remote *	G31-**-17	1,950 40#	2,005 46#	2,175 50#
G31 Burner with Electronic Valve and on/off Remote *	G31-**-02	2,239 42#	2,294 48#	2,464 52#
G31 Burner with Electronic Variable Valve and Remote *	G31-**-2VT	2,261 42#	2,316 48#	2,486 52#

* Shipped for use with Natural Gas - Specify if for Propane Gas by adding a "P" to the model number (e.g. G31-24/30-02P).

G52 Radiant Fyre System & Fiber Enhanced Ceramic Logs

- Featuring specially formulated, hand-crafted **Charred Evergreen Oak, Charred Evergreen Split Oak, Colonial Oak, & Burnt Aspen Logs.**
- **Burner System Includes:** Advanced Radiant Fyre Burner • Exclusive radiant stainless steel booster grid • Custom grate • Platinum Embers • Glowing Embers • Sand (NG) or Vermiculite (LP) • Connector Kit & Damper Clamp • Choice of pre-assembled Electronic Remote Control, Automatic Variable Control with Remote, pre-assembled Manual Pilot Kit, or Match-Lit System (Natural Gas only).

C. Fiber Enhanced Ceramic Gas Logs Only

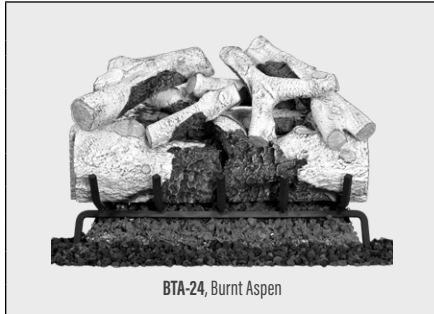

DESCRIPTION	MODEL #	18"	24"	30"
Charred Evergreen Oak	ENO-**	\$577 36#	\$637 48#	\$761 58#
Charred Evergreen Split Oak	ENS-**	603 36#	673 48#	804 58#
Colonial Oak	COLO-**	553 36#	606 48#	723 58#
Burnt Aspen	BTA-**	616 36#	683 48#	816 58#

D. G52 Radiant Fyre Burner System Only



DESCRIPTION	MODEL #	18/20"	24/30"
G52 Burner, Match Lit without Valve <i>(Natural Gas only)</i>	G52-**	\$866 34#	\$938 38#
G52 Burner with Manual Valve and Standing Pilot *	G52-**-A	1,216 37#	1,288 41#
G52 Burner with Automatic Variable Valve and Remote *	G52-**-17	1,569 37#	1,641 41#
G52 Burner with Electronic Valve and on/off Remote *	G52-**-02	1,858 38#	1,930 42#
G52 Burner with Electronic Variable Valve and Remote *	G52-**-2VT	1,883 38#	1,955 42#

* Shipped for use with Natural Gas - Specify if for Propane Gas by adding a "P" to the model number (e.g. G52-24/30-17P).

E. G52 Radiant Fyre Burner Outdoor System Only (Stainless Steel)



DESCRIPTION	MODEL #	18/20"	24/30"
G52 Outdoor Burner, Match Lit without Valve <i>(Natural Gas only)</i>	G52-**-SS	\$1,120 34#	\$1,223 38#
G52 Outdoor Burner with Manual Valve and Standing Pilot *	G52-**-NA-SS	1,491 37#	1,594 41#

* Shipped for use with Natural Gas - Specify if for Propane Gas by adding a "P" to the model number (e.g. G52-24/30-NA-P-SS).

P45 Pan Burner, Compatible Logs, & Fyre Spheres

- Featuring specially formulated, hand-crafted **Charred Evergreen Oak, Charred Evergreen Split Oak, Colonial Oak, & Burnt Aspen Logs.**
- **P45 Series Burner Systems Include:** Certified Pan Burner with Pre-assembled Control Valve & Regulator, Burner Legs, Vermiculite, Connector Kit and Damper Clamp.

F. P45 Gas Log Sets Only



DESCRIPTION	MODEL #	18"	24"	30"
Shoreline Designer Oak	S0-**-**	\$374 10 pcs.	\$423 12 pcs.	\$544 15 pcs.
Shoreline Driftwood	SDW-**-**	265 9 pcs.	299 11 pcs.	396 13 pcs.

G. P45 Fyre Spheres Only

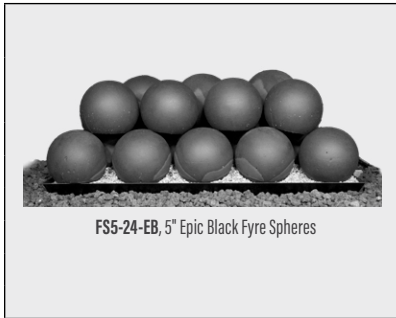

DESCRIPTION	MODEL #	18"	24"	30"
4" Epic Black Fyre Spheres	FS4-**-EB	\$280 19 pcs.	\$353 24 pcs.	\$500 34 pcs.
4" Graystone Fyre Spheres	FS4-**-GS	252 19 pcs.	318 24 pcs.	452 34 pcs.
5" Epic Black Fyre Spheres	FS5-**-EB	310 14 pcs.	420 19 pcs.	529 24 pcs.
5" Graystone Fyre Spheres	FS5-**-GS	279 14 pcs.	377 19 pcs.	478 24 pcs.

NEW H. Mixed Select Fyre Sphere Sets Only



DESCRIPTION	MODEL #	18"	24"	30"
Epic Black Mixed Select Fyre Spheres Set	FSM-**-EB	\$223 (4) 4-Packs	\$316 (6) 4-Packs	\$483 (8) 4-Packs
Graystone Mixed Select Fyre Spheres Set	FSM-**-GS	204 (4) 4-Packs	290 (6) 4-Packs	441 (8) 4-Packs

18" Sets Includes:

- (1) 4-Pk. of 2" Spheres
- (1) 4-Pk. of 3" Spheres
- (1) 4-Pk. of 4" Spheres
- (1) 4-Pk. of 5" Spheres

24" Sets Includes:

- (2) 4-Pk. of 2" Spheres
- (1) 4-Pk. of 3" Spheres
- (2) 4-Pk. of 4" Spheres
- (1) 4-Pk. of 5" Spheres

30" Sets Includes:

- (3) 4-Pk. of 2" Spheres
- (1) 4-Pk. of 3" Spheres
- (2) 4-Pk. of 4" Spheres
- (1) 4-Pk. of 5" Spheres
- (1) 4-Pk. of 6" Spheres

I. P45 Series ANSI Certified Standard & Glass Pan Burners

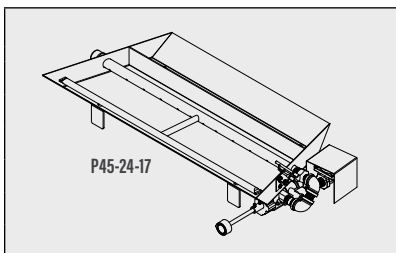

DESCRIPTION	MODEL #	18"	24"	30"
P45 Pan Burner Match Lit (Natural Gas Only) †	P45-**-**	\$335 23#	\$361 26#	\$405 31#
P45 Pan Burner with Manual Valve and Standing Pilot †	P45-**-A	642 25#	668 28#	712 33#
P45 Pan Burner with Automatic Variable Valve and Remote †	P45-**-17	986 25#	1,012 28#	1,056 33#

Shipped for use with Natural Gas - Specify if for Propane Gas by adding a "P" to the model number (e.g. P45-24-17P).

† Glass burners do not include grate or embers. For Glass Media Options see page 14.

A. ON/OFF Bluetooth Control System



DESCRIPTION	MODEL #	PRICE
ON/OFF Bluetooth Control with Golden Oak Cover	RF-BTSR1-G	\$234
ON/OFF Bluetooth Control with White Birch Cover	RF-BTSR1-B	240

Burner System Compatibility			Control Valve Compatibility				
BURNER KITS	-02 Series	-11 Series	VALVES	-01 Series	-02 Series	-10 Series	-11 Series
G31	●	●	APK			●	●
G45	●	●	EPK	●	●		
G46	●	●	EPK-2M-AD		●		
G52	●						
PB	●	●					

B. Safety Control Valve Systems

DESCRIPTION	MODEL #	PRICE
Low Profile, Safety Pilot Kit with removable knob handle	SPK-26 *	\$218
High Capacity, Automatic Pilot Kit with basic transmitter & receiver	APK-10 *	894
Automatic Pilot Kit with basic transmitter & receiver	APK-11 *	646
Variable, Automatic Pilot Kit with basic transmitter & receiver	APK-15 (or APK-15P) ‡	716
Low Profile, Variable, Automatic Pilot Kit with basic transmitter & receiver	APK-17 *	566
Electronic Pilot Kit with on/off basic transmitter & receiver	EPK-2 (or EPK-2P) ‡	827
110 Volt Powered Electronic, non-standing pilot system designed to be installed outside the firebox	EPK-2M-AD (or EPK-2M-AD/LP) ‡	793
110 Volt Powered Electronic, non-standing pilot system with variable flame height control	EPK-2V-TR (or EPK-2VP-TR) ‡	1,030
High Capacity, 110 Volt Powered Electronic, non-standing pilot system w/variable flame height control	EPK-3V-TR (or EPK-3VP-TR) ‡	1,173
Manual On/Off Valve with knob handle	AV-17	79
Case of 12 - Manual On/Off Valves w/ knob handle	AV-17-12	935
Manual On/Off Valve with extension handle	AV-18	82
Case of 12 - Manual On/Off Valves w/ extension handle	AV-18-12	976
Straight Line Gas Valve with Key	AV-30	68

* = Field convertible Propane Orifice Included. Specify if for Propane by adding a "P" to the model number (e.g. **APK-17P**).

‡ = Not Field Convertible. Kit **Must** be ordered for specific gas (e.g. **APK-15** for Natural Gas or **APK-15P** for Propane).

C. Remote Compatible Options & Accessories



DESCRIPTION	MODEL #	PRICE
Basic ON/OFF Receiver/Transmitter Set	RR-1A	\$123
Deluxe ON/OFF Receiver/Transmitter Set	RR-2A	179
Basic Variable Receiver/Transmitter Set for "15" & "17" Style Models	VR-1A	149
Deluxe Variable Receiver/Transmitter Set for "15" & "17" Style Models	VR-2A	204
Wall Switch, Cover and Wiring	WS-1	71
Wall Timer, Cover and Wiring	WS-2	174
Wall Switch, Cover and Wiring ("15" & "17" Models Only)	WS-3	87

G4 & G45 Burner Size Compatibility for Safety Valves

VALVE MODEL	GAS TYPE	MAX BTU † INPUT	G4 & G45 STANDARD	G45-2 SEE-THRU
SPK-26	N.G.	100,000	12" - 36"	16" - 30"
SPK-26P	L.P.	200,000	12" - 60"	16" - 60"
APK-10	N.G.	230,000	12" - 60"	16" - 60"
APK-10P	L.P.	372,000	12" - 60"	16" - 60"
APK-11	N.G.	70,000	12" - 30"	16" - 18"
APK-11P	L.P.	110,000	12" - 42"	16" - 30"
APK-15	N.G.	85,000	12" - 30"	16" - 18"
APK-15P	L.P.	135,000	12" - 42"	16" - 36"
APK-17	N.G.	100,000	12" - 42"	16" - 30"
APK-17P	L.P.	200,000	12" - 60"	16" - 60"
EPK-2	N.G.	120,000	12" - 42"	16" - 30"
EPK-2P	L.P.	190,000	12" - 60"	16" - 60"
EPK-2M-AD	N.G.	120,000	12" - 30"	16" - 18"
EPK-2M-AD/LP	L.P.	190,000	12" - 42"	16" - 30"
EPK-2V-TR	N.G.	120,000	12" - 42"	16" - 30"
EPK-2VP-TR	L.P.	180,000	12" - 60"	16" - 60"
EPK-3V-TR	N.G.	200,000	12" - 60"	16" - 60"
EPK-3VP-TR	L.P.	320,000	12" - 60"	16" - 60"

† Using Real Fyre® Burner Systems

VII Glass Media & Fyre Spheres

A. Fyre Glass



AVAILABLE COLORS	10 lb. Package \$103	40 lb. Bucket \$414
Azuria	GL-10-F	GL-40-F
Black	GL-10-B	GL-40-B
Bronze	GL-10-Z	GL-40-Z
Caribbean Blue	GL-10-N	GL-40-N
Clear	GL-10-C	GL-40-C
Emerald	GL-10-E	GL-40-E
Star Fyre	GL-10-W	GL-40-W

B. Reflective Fyre Glass

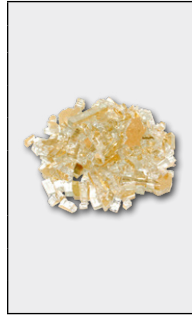

AVAILABLE COLORS	10 lb. Package \$114	40 lb. Bucket \$451
Azuria Reflective	GL-10-FR	GL-40-FR
Black Reflective	GL-10-BR	GL-40-BR
Bronze Reflective	GL-10-ZR	GL-40-ZR
Caribbean Blue Refl.	GL-10-NR	GL-40-NR
Copper Reflective	GL-10-OR	GL-40-OR
Emerald Reflective	GL-10-ER	GL-40-ER
Gold Reflective	GL-10-HR	GL-40-HR
Champagne Reflective	GL-10-CR	GL-40-CR

C. Fyre Gems

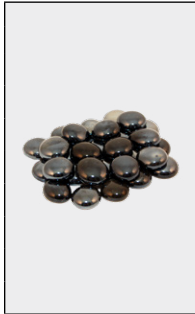

AVAILABLE COLORS	10 lb. Package \$87	40 lb. Bucket \$343
Black Pearl	GLG-10-J	GLG-40-J
Blue Topaz	GLG-10-T	GLG-40-T
Champagne	GLG-10-D	GLG-40-D
Deep Amber	GLG-10-A	GLG-40-A
Emerald	GLG-10-E	GLG-40-E
Glacier	GLG-10-C	GLG-40-C
Sapphire	GLG-10-S	GLG-40-S
Ruby	GLG-10-RY	GLG-40-RY

D. Diamond Nuggets

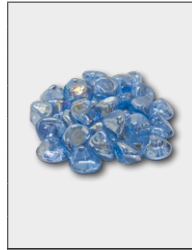

AVAILABLE COLORS	10 lb. Package \$99	40 lb. Bucket \$398
Clear	GLD-10-C	GLD-40-C
Steel Blue	GLD-10-SB	GLD-40-SB
Rosé	GLD-10-R	GLD-40-R
Emerald	GLD-10-E	GLD-40-E
Pacific Blue	GLD-10-PB	GLD-40-PB
Deep Black	GLD-10-DB	GLD-40-DB

E. Fyre Spheres

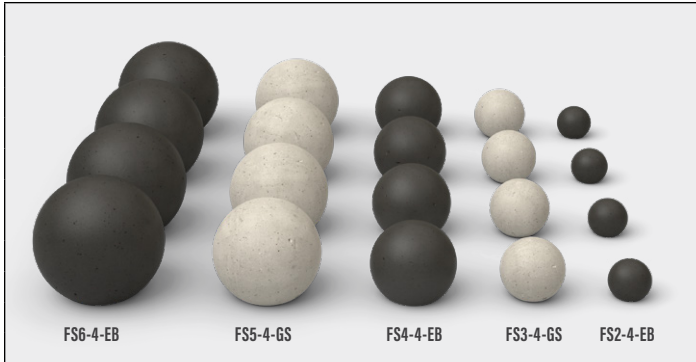

DESCRIPTION	COLOR	MODEL #	PRICE
2" Fyre Spheres (4 in a box)	Epic Black	FS2-4-EB	\$40
	Graystone	FS2-4-GS	37
3" Fyre Spheres (4 in a box)	Epic Black	FS3-4-EB	50
	Graystone	FS3-4-GS	46
4" Fyre Spheres (4 in a box)	Epic Black	FS4-4-EB	58
	Graystone	FS4-4-GS	53
5" Fyre Spheres (4 in a box)	Epic Black	FS5-4-EB	87
	Graystone	FS5-4-GS	79
6" Fyre Spheres (4 in a box)	Epic Black	FS6-4-EB	135
	Graystone	FS6-4-GS	122

VIII Accessories

NEW A. Flame Enhancer Kit (Compatible with G4 & G45 Burners)

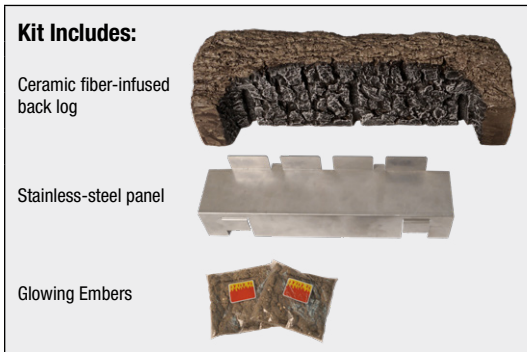

DESCRIPTION	MODEL #	PRICE
18" Flame Enhancer Kit	FE-18	\$192
24" Flame Enhancer Kit	FE-24	264
30" Flame Enhancer Kit	FE-30	287

LOG SET	SIZE COMPATIBILITY		
	FE-18	FE-24	FE-30
CHD-	18/20	24	30
CHAO-	18/20	24	30
CHS-	18/20	24	30
CHB-	18/20	24	30
HCHS-	18/20	24	30
HCHR-	18/20	24	30
PN-	--	24	30
CHMJ-	--	24	30
HRD-	18	24	30
AO-	18	24	30
S-	18, 20	24	30
WO-	18, 20	24	30
BD-	18	24	30
PO-	18, 20	24	30
HR-	18	24	--
B-	18	24	30
R	18, 20	24	30

B. Three-Panel Fyrebacks

Traditional Contemporary

Fyreback Dimension Chart

	A*	B	C	D
SMALL (for 18" log sets)	16"	16.5"	11"	14"
MEDIUM (for 24" log sets)	16"	21.5"	12"	14"
LARGE (for 30" log sets)	16"	26.5"	13"	14"
X LARGE (for 36" log sets)	16"	31.5"	14"	14"

* Add 1" to A dimension for Traditional Models

DESCRIPTION	SIZE	Traditional #	Contemporary #	WT.	PRICE
Satin Stainless Fyreback	S	FBS-18	FBC-18	10 lb.	\$128
	M	FBS-24	FBC-24	12	146
	L	FBS-30	FBC-30	14	162
	XL	FBS-36	FBC-36	17	179
Polished Stainless Steel Fyreback	S	FBSP-18	FBCP-18	10	196
	M	FBSP-24	FBCP-24	12	206
	L	FBSP-30	FBCP-30	14	220
	XL	FBSP-36	FBCP-36	17	273
Black Porcelain Fyreback	S	FBSB-18	FBCB-18	10	198
	M	FBSB-24	FBCB-24	12	214
	L	FBSB-30	FBCB-30	14	237
	XL	FBSB-36	FBCB-36	17	276

C. Decor Packs, Refresh Kit, & Burner Affix Kit



DESCRIPTION	INCLUDES	MODEL #	WT.	PRICE
Decor Pack (Case of 6)	4 small size Wood Chips and 3 small size Pine Cones (vacuum packed)	DP-2-6	18 lb.	\$445
Ember Enhancing Decor Pack	Bryte Coals, Lava Coals, 2 Pine Cones, and 2 Wood Chips	DP-5	10	113
Ember Enhancing Decor Pack	Bryte Coals, Lava Coals, 2 Pine Cones, 2 Wood Chips, and 2 Acorns	DP-7	12	121
Holiday Decor Pack (Case of 6)	2 Acorns, 2 Pine Cones, and 4 Wood Chips (vacuum packed)	HDK-1-6	18	630
Refresh Kit	Ember Glow, Sand (NG) or Vermiculite (LP), Bryte Coals, Lava Granules, and Acorns	RK-1 / RK-1P	26	135
Burner Affix Kit	Mounting Bracket, Screw, and Silicone	AFK-1	1	38

D. Decorative Branches & Bonus Logs



DESCRIPTION	MODEL #	WT.	PRICE
9" Oak Branches (2 in a box)	BR-2	3 lb.	\$51
17" Oak Branch	BR-17	6	62
Charred Branches (4 vacuum packed)	BDC-4	11	124
Charred Accessory Kit (4 pcs. vacuum packed)	Single CHA-1	2	80
	Case of 6 CHA-1-6	12	482
Special Designer Bonus Logs (2 in a box)	SD-BONUS	13	108
Special Split Logs (2 in a box)	SS-BONUS	8	118
Special Birch Bonus Logs (2 in a box)	SB-BONUS	12	120
Charred Series Chunk	CHC-01	2	33
Wood Chip Ring (vacuum packed)	WCRD-1	3	46

E. River Rocks & Wood Chunks



DESCRIPTION	COLOR	MODEL #	PRICE
River Rock Fyre Stones (set of 10 assorted sizes)	Assorted	STN-10	\$142
	Ivory	STN-10I	
	Slate	STN-10S	
	Terracotta	STN-10T	
Designer River Rock Fyre Stones (set of 20 assorted sizes)	Assorted	STN-20	332
Designer Wood Chunks (set of 36 assorted sizes)	--	WCD-36	310

F. Pine Cones, Wood Chips, & Acorns

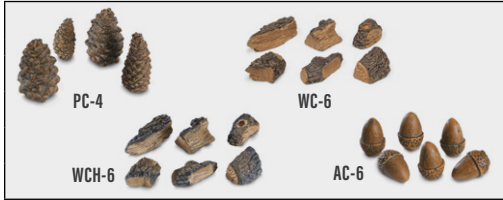

DESCRIPTION	MODEL #	WT.	PRICE
4 Designer Pine Cones <i>(assorted sizes, vacuum packed)</i>	Case of 6 PC-4-6	22 lb.	\$328
6 Wood Chips <i>(vacuum packed)</i>	Case of 6 WC-6-6	22	393
6 Charred Wood Chips <i>(vacuum packed)</i>	Case of 6 WCH-6-6	22	440
6 Acorns <i>(vacuum packed)</i>	Case of 6 AC-6-6	15	281

G. Gas Log Burner Kit Accessories



DESCRIPTION	MODEL #	WT.	PRICE
Ember Glow	Single EM-1	6 oz.	\$29
	Case of 12 EM1-12	5 lb.	338
Super Embers <i>(includes Bryte Coals)</i>	EM-1S	7 oz.	56
Bryte Coals	EM-11	2 oz.	34
Black Embers	Single EB-1	6 oz.	36
	Case of 12 EB-12	5 lb.	418
Select White Sand <i>(10 lb. bag)</i>	Single CS-10	10 lb.	29
	Case of 6 CS-10-6	66 lb.	169
Vermiculite Granules	Single LF-15	1.5 lb.	33
	Case of 12 LF-15-12	18 lb.	386
Lava-Fyre Granules <i>(5 lb. bag)</i>	Single LF-5	5 lb.	25
	Case of 12 LF-5-12	68 lb.	287
Lava-Fyre Granules <i>(10 lb. bag)</i>	Single LF-10	10 lb.	40
	Case of 6 LF-10-6	63 lb.	232
Lava-Fyre Coals <i>(10 lb. bag)</i>	Single LFC-10	10 lb.	47
	Case of 6 LFC-10-6	66 lb.	274
Assorted Lava Stones <i>(15 lb. box)</i>	LVS-15	15 lb.	68
Assorted Lava Stones <i>(35 lb. box)</i>	LVS-35	35 lb.	110

H. Additional Accessories



DESCRIPTION	MODEL #	WT.	PRICE
Charred Birch Decorative Cover <i>(vacuum packed)</i>	Single WCBC-1	2 lb.	\$62
	Case of 6 WCBC-1-6	12 lb.	362
Charred Birch Decorative Wood Chunk	Single WCAB-1	2 lb.	62
	Case of 6 WCAB-1-6	12 lb.	364
Wood Chunk Decorative Cover <i>(vacuum packed)</i>	Single WCDC-1	2 lb.	52
	Case of 6 WCDC-1-6	12 lb.	305
Pine Cone Decorative Cover <i>(vacuum packed)</i>	Single PCDC-1	2 lb.	56
	Case of 6 PCDC-1-6	12 lb.	329
Valve Cover, Designer <i>(vacuum packed)</i>	WCEC-1	7 lb.	68
Valve Cover, Charred <i>(vacuum packed)</i>	CHEC-1	7 lb.	67
Stainless Steel Grate <i>(recommended for Outdoor Fireplaces)</i>	18" size SD-18-SS	11 lb.	247
	24" size SD-24-SS	12 lb.	390
	30" size SD-30-SS	15 lb.	465
Rigid Gas Log Lighter <i>(for Natural Gas Only)</i>	Single LG-1	2 lb.	59
	Case of 12 LG-1-12	19 lb.	693
Gasaver Gas Log Lighter <i>(for Natural Gas Only)</i>	Single LL-1	2 lb.	69
	Case of 12 LL-1-12	19 lb.	821
14" Cast Iron Gas Log Lighter <i>(for Natural Gas Only)</i>	LC-1	5 lb.	95
Cast Iron Fender <i>(for All Gas Log Sets)</i>	18" size FF-04-18	8 lb.	73
	24" size FF-04-24	10 lb.	84
	30" size FF-04-30	12 lb.	101