

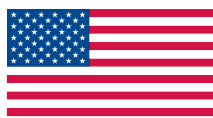

MONTIGO[®]









Price Pages



USA VERSION
MARCH 1 2025

Interactive Catalog

VENTING

 <p>NEW WOOD VENTING FOR WILDFIRE FIREPLACES</p>	 <p>WOOD VENT</p>	 <p>4/7 VENT</p>	 <p>5/8 VENT</p>	 <p>5/10 VENT</p>
	 <p>VENT ADAPTERS</p>	 <p>FLEX KITS</p>	 <p>POWER VENT</p>	



UPDATES:

- New Venting pages

NEW ITEMS:

- Paragon
- Wood fireboxes

MISCELLANEOUS

 <p>MEDIA</p>	 <p>APP & MISC.</p>	 <p>COOL WALL</p>
--	--	--

This document is for pricing and ordering purposes only. For installation or technical information, refer to the appropriate installation instructions and your local building codes.

Optional glass media is priced out for one (1) bag, see unit descriptions for quantity required.

Consult your Montigo representative regarding models equipped for use at high altitudes [+4,500ft above sea level].

Shipping weights and dimensions are listed in the unit description, these should be used as a general guideline and may not be exact.

DELRAY

DISTINCTION

NEW

PARAGON

**DIVINE
MULTI SIDED**

EXEMPLAR

**SINGLE
SIDED**

**SEE
THROUGH**

PHENOM

INSERTS

OUTDOOR

NEW

**WILDFIRE
FIREBOXES**



DelRay Linear 36", 48"

NOTES:

For optional glass media SKU and price (firestones, firebeads, fireglass) please refer to media page. The quantity of bags required can be found in the unit description.

MUST ORDER: Fireplace

A Select the fireplace:

DRL3613NI

16,000 BTU NG model with Proflame 2 Basic IPI 4"/7" venting. Supplied with 6 lbs. of Ice fireglass. [HW1157]

DelRay 36 Basic	NG	DRL3613NI	\$2,599.00
NG to LP Conversion Kit	LP	GCA010	\$99.00
Shipping Weight: 127lb Length: 46" Width: 14" Height: 29"			

DRL3613NI-2 FULL LOAD

16,000 BTU NG model equipped with Proflame 2 IPI, reflective glass panels, downlighting, remote control, fan kit, micro mesh screen, 4"/7" venting. Supplied with 6 lbs. of Ice fireglass. [HW1157]

DelRay 36 Full Load	NG	DRL3613NI-2	\$3,709.00
NG to LP Conversion Kit	LP	GCA010	\$99.00
Shipping Weight: 153lb Length: 46" Width: 14" Height: 29"			

DRL4813NI

21,000 BTU NG model with Proflame 2 Basic IPI 4"/7" venting. Supplied with 9 lbs. of Ice fireglass. [HW1157]

DelRay 48 Basic	NG	DRL4813NI	\$3,409.00
NG to LP Conversion Kit	LP	GCA019	\$99.00
Shipping Weight: 165lb Length: 57" Width: 14" Height: 29"			

DRL4813NI-2 FULL LOAD

21,000 BTU NG model equipped with Proflame 2 IPI, reflective glass panels, downlighting, remote control, fan kit, micro mesh screen, 4"/7" venting. Supplied with 9 lbs. of Ice fireglass. [HW1157]

DelRay 48 Full Load	NG	DRL4813NI-2	\$4,889.00
NG to LP Conversion Kit	LP	GCA019	\$99.00
Shipping Weight: 190lb Length: 57" Width: 14" Height: 29"			

Optional components:

DELRAY UNIVERSAL ACCESSORIES

Direct Vent Adapter to 5" B-vent	BVK35	\$274.00
DRL3613 1" Adjustable Trim Kit	DRLT36	\$129.00
DRL3613 1" Adjustable Trim Kit [extra deep]	DRLT36-2	\$179.00
DRL4813 1" Adjustable Trim Kit	DRLT48	\$154.00
DRL4813 1" Adjustable Trim Kit [extra deep]	DRLT48-2	\$219.00

Standard kit for up to 11/16" deep facing materials
Extra deep kit for 1 1/2"-2" deep facing materials

DELRAY FULL LOAD ACCESSORIES

Wall Mounted Proflame 2 Remote	REC1550	\$334.00
Proflame 2 WiFi Dongle	SIT-WIFI	\$244.00

DELRAY BASIC ACCESSORIES

Battery Back-up	AF40BP	\$27.00
Remote [on/off only]	RX40	\$329.00
Remote [on/off + thermostatic control]	RX60	\$419.00
DelRay Fan Kit	DRFK1	\$399.00
DRL3613 Reflective Glass Panel Kit	RBGDRL36	\$539.00
DRL4813 Reflective Glass Panel Kit	RBGDRL48	\$749.00
DRL3613 micro mesh screen	SCRIDRL36	\$319.00
DRL4813 micro mesh screen	SCRIDRL48	\$419.00

Optional decorative media:

MEDIA OPTIONS

DRL36 Speckled Stones	RR150SS	\$244.00
DRL48 Speckled Stones	RR200SS	\$354.00
DRL36 Driftwood Logset	LGS76	\$239.00
DRL48 Driftwood Logset	LGS77	\$309.00

Flame turndown not available on 36" and 48" units (basic AND full load)
Ω Mobile home compatible units can be ordered by adding an (MH) to the end of the unit order code



LINEAR 36,48,60

LINEAR 72

NOT COMPATIBLE

NOT COMPATIBLE

COMPATIBLE

COMPATIBLE ALTERNATIVE

COMPATIBLE

NEW PRODUCT

DelRay Linear 60", 72"

NOTES:

For optional glass media SKU and price (firestones, firebeads, fireglass) please refer to media page. The quantity of bags required can be found in the unit description.

**BETTER OPTION:
COOL WALL
RELEASE**

NOTES:

DelRay fireplaces have the installation feature of opening the venting ports and ventilating the chase, known as "Cool Wall Release". This allows for the usage of combustible facing material, as well as negating the need for the included cement board and stud heat deflector. Components like liners, plenums, and louvers that are part of a "Cool Wall Advantage" kit are not required but are a compatible alternative.

MUST ORDER: Fireplace

A Select the fireplace:

DRL6013NI

28,000 BTU NG model with Proflame 2 Basic IPI 4"/7" venting. Supplied with 9 lbs. of Ice fireglass. [HW1157]

DelRay 60 Basic	NG	DRL6013NI	\$4,279.00
NG to LP Conversion Kit	LP	GCA047	\$99.00

Shipping Weight: 209lb Length: 74" Width: 14" Height: 29"

DRL6013NI-2 FULL LOAD

28,000 BTU NG model equipped with Proflame 2 IPI, reflective glass panels, downlighting, remote control, fan kit, micro mesh screen, remote Hi-Lo flame control, 4"/7" venting. Supplied with 9 lbs. of Ice fireglass. [HW1157]

DelRay 60 Full Load	NG	DRL6013NI-2	\$6,099.00
NG to LP Conversion Kit	LP	GCA048	\$99.00

Shipping Weight: 231lb Length: 74" Width: 14" Height: 29"

DRL7213NI

32,000 BTU NG model with Proflame 2 Basic IPI 5"/8" venting. Supplied with 9 lbs. of Ice fireglass. [HW1157]

DelRay 72 Basic	NG	DRL7213NI	\$5,099.00
NG to LP Conversion Kit	LP	GCA052	\$99.00

Shipping Weight: 320lb Length: 88" Width: 14" Height: 29"

DRL7213NI-2 FULL LOAD

35,000 BTU NG model equipped with Proflame 2 IPI, reflective glass panels, downlighting, remote control, fan kit, micro mesh screen, remote Hi-Lo flame control, 5"/8" venting. Supplied with 9 lbs. of Ice fireglass. [HW1157]

DelRay 72 Full Load	NG	DRL7213NI-2	\$7,139.00
NG to LP Conversion Kit	LP	GCA053	\$99.00

Shipping Weight: 320lb Length: 88" Width: 14" Height: 29"

Optional components:

DELRAY UNIVERSAL ACCESSORIES

Direct Vent Adapter to 5" B-vent	BVK35	\$274.00
DRL6013 1" Adjustable Trim Kit	DRLT60	\$179.00
DRL6013 1" Adjustable Trim Kit [extra deep]	DRLT60-2	\$249.00
DRL7213 1" Adjustable Trim Kit	DRLT72	\$214.00
DRL7213 1" Adjustable Trim Kit [extra deep]	DRLT72-2	\$299.00

DRL60 ONLY

Standard kit for up to 11/16" deep facing materials
Extra deep kit for 1 1/2"-2" deep facing materials

DELRAY FULL LOAD ACCESSORIES

Wall Mounted Proflame 2 Remote	REC1550	\$334.00
Proflame 2 WiFi Dongle	SIT-WIFI	\$244.00

DELRAY BASIC ACCESSORIES

Battery Back-up	AF40BP	\$27.00
Remote [on/off only]	RX40	\$329.00
Remote [on/off + thermostatic control]	RX60	\$419.00
DelRay Fan Kit	DRFK1	\$399.00
DRL6013 Reflective Glass Panel Kit	RBGDRL60	\$959.00
DRL6013 micro mesh screen	SCRIDRL60	\$529.00
DRL7213 Reflective Glass Panel Kit	RBGDRL72	\$1,090.00
DRL7213 micro mesh screen	SCRIDRL72	\$619.00

Optional decorative media:

MEDIA OPTIONS

DRL60 Speckled Stones	RR300SS	\$519.00
DRL72 Speckled Stones	RR400SS	\$691.00
DRL60 Driftwood Logset	LGS77	\$309.00
DRL60 Driftwood Kit Small	LGS59	\$284.00
DRL72 Driftwood Kit	LGS77	\$309.00
DRL72 Driftwood Kit Small	LGS59	\$284.00
DRL72 Driftwood Kit Large	LGS57	\$294.00

ORDER BOTH

XP0116 - Released March 1 2025
Prices shown in USD and subject to change without notice

Ω Mobile home compatible units can be ordered by adding an (MH) to the end of the unit order code



NEW PRODUCT

DelRay Square 34"

NOTES:

For optional glass media SKU and price (firestones, firebeads, fireglass) please refer to media page. The quantity of bags required can be found in the unit description.

MUST ORDER: A Fireplace B Media System

A Select the fireplace:

DELRAY SQUARE 34 BASIC

15,000 BTU NG model with Proflame 2 BASIC IPI 4"/7" venting
MUST ORDER MEDIA SYSTEM TO COMPLETE INSTALLATION (If using glass media, 4lbs. are required)

DelRay Square 34 Basic	NG	DRSQ34NI	\$2,669.00
NG to LP Conversion Kit	LP	GCA028	\$99.00
Shipping Weight: 127lb Length: 46" Width: 14" Height: 29"			

DELRAY SQUARE 34 FULL LOAD

18,000 BTU NG model equipped with Proflame 2 IPI, multi-function remote control, remote Hi-Lo flame control, remote controlled fans, micro mesh screen, battery backup, halogen downlighting, 4"/7" venting
MUST ORDER MEDIA SYSTEM TO COMPLETE INSTALLATION (If using glass media, 4lbs. bags are required)

DelRay Square 34 Full Load	NG	DRSQ34NI-2	\$3,739.00
NG to Propane Conversion Kit	LP	GCA029	\$99.00
Shipping Weight: 153lb Length: 46" Width: 14" Height: 29"			

Optional liners:

DELRAY LINERS

Grey Herringbone Brick	DRSQBK34GH	\$264.00
Ash Fluted Brick	DRSQBK34AF	\$264.00
Grey Ledgestone	DRSQBK34GL	\$264.00
Vintage Brown Brick	DRSQBK34VB	\$264.00
Tan Brick	DRSQBK34TB	\$264.00
Red Brick	DRSQBK34RB	\$264.00
Black Reflective Glass	RBGDRSQ34	\$469.00

Fireplaces come with a satin black painted finish and do not require a liner

Ω Mobile home compatible units can be ordered by adding an (MH) to the end of the unit order code

B Select a media system:

DELRAY TRADITIONAL SETS

Driftwood	LGSDW38	\$264.00
Birch	LGSBI38	\$264.00
Split Oak	LGSSO38	\$264.00

All traditional scenes come with a logset and Black Coal fuelbed and embers

DELRAY CONTEMPORARY SCENES

Winter Contemporary Scene	CSW34	\$179.00
Twilight Contemporary Scene	CST34	\$199.00
Beach Contemporary Scene	CSB34	\$219.00

MEDIA OPTIONS

Speckled Stones 150pc	RR150SS	\$244.00
Red Coals	HW1266	\$66.00
Grey Coals	HW1265	\$66.00
Black Coals	HW1267	\$66.00

ORDER 2 IF BEING USED WITHOUT A LOGSET

Optional components:

DELRAY UNIVERSAL ACCESSORIES

Direct Vent Adapter to 5" B-vent	BVK35	\$274.00
DRSQ34 1" Adjustable Trim Kit	DRSQT34	\$119.00
DRSQ34 1" Adjustable Trim Kit [extra deep]	DRSQT34-2	\$174.00

Standard kit for up to 11/16" deep facing materials
 Extra deep kit for 1 1/2"-2" deep facing materials

DELRAY FULL LOAD ACCESSORIES

Wall Mounted Proflame 2 Remote	REC1550	\$334.00
Proflame 2 WiFi Dongle	SIT-WIFI	\$244.00

DELRAY BASIC ACCESSORIES

Battery Back-up	AF40BP	\$27.00
Remote [on/off only]	RX40	\$329.00
Remote [on/off + thermostatic control]	RX60	\$419.00
DelRay Square Fan Kit	DRFK2	\$399.00
DelRay Square 34 micro mesh screen	SCRIDRSQ34	\$219.00

XP0116 - Released March 1 2025
 Prices shown in USD and subject to change without notice



DRSQ34
DRSQ38 REDUCED

DRSQ38

NOT COMPATIBLE

NOT COMPATIBLE

COMPATIBLE

COMPATIBLE ALTERNATIVE
BETTER OPTION:
COOL WALL
RELEASE

COMPATIBLE



DelRay Square 38"

NOTES:
For optional glass media SKU and price (firestones, firebeads, fireglass) please refer to media page. The quantity of bags required can be found in the unit description.

NOTES:
DelRay fireplaces have the installation feature of opening the venting ports and ventilating the chase, known as "Cool Wall Release". This allows for the usage of combustible facing material, as well as negating the need for the included cement board and stud heat deflector. Components like liners, plenums, and louvers that are part of a "Cool Wall Advantage" kit are not required but are a compatible alternative.

MUST ORDER: F Fireplace B Media System

A Select the fireplace:

DELRAY SQUARE 38 BASIC

20,500 BTU NG model with Proflame 2 BASIC IPI 5"/8" venting
MUST ORDER MEDIA SYSTEM TO COMPLETE INSTALLATION (If using glass media, 5lbs. are required)

DelRay Square 38 Basic	NG	DRSQ38NI	\$2,959.00
NG to LP Conversion Kit	LP	GCA020	\$99.00
5"/8" to 4"/7" Reducing Collar [top vent only]		DRSQCOL47	\$164.00

Shipping Weight: 127lb Length: 46" Width: 14" Height: 29"

DELRAY SQUARE 38 FULL LOAD

24,000 BTU NG model equipped with Proflame 2 IPI, multi-function remote control, remote Hi-Lo flame control, remote controlled fans, Micro mesh screen, battery backup, halogen downlighting, 5"/8" venting
MUST ORDER MEDIA SYSTEM TO COMPLETE INSTALLATION (If using glass media, 5lbs. are required)

DelRay Square 38 Full Load	NG	DRSQ38NI-2	\$4,189.00
NG to LP Conversion Kit	LP	GCA021	\$99.00
5"/8" to 4"/7" Reducing Collar [top vent only]		DRSQCOL47	\$164.00

Shipping Weight: 153lb Length: 46" Width: 14" Height: 29"

Optional liners:

DELRAY LINERS

Gray Herringbone Brick	DRSQBK38GH	\$319.00
Ash Fluted Brick	DRSQBK38AF	\$319.00
Grey LedgeStone	DRSQBK38GL	\$319.00
Vintage Brown Brick	DRSQBK38VB	\$319.00
Tan Brick	DRSQBK38TB	\$319.00
Red Brick	DRSQBK38RB	\$319.00
Black Reflective Glass	RBGDRSQ38	\$529.00

Fireplaces come with a satin black painted finish and do not require a liner

Ω Mobile home compatible units can be ordered by adding an (MH) to the end of the unit order code

B Select a media system:

DELRAY TRADITIONAL SETS

Driftwood	LGSDW38	\$264.00
Birch	LGSBI38	\$264.00
Split Oak	LGSSO38	\$264.00

All traditional scenes come with a logset and Black Coal fuelbed and embers

DELRAY CONTEMPORARY SCENES

Winter Contemporary Scene	CSW38	\$264.00
Twilight Contemporary Scene	CST38	\$264.00
Beach Contemporary Scene	CSB38	\$259.00

MEDIA OPTIONS

Speckled Stones 150pc	RR150SS	\$244.00
Red Coals	HW1266	\$66.00
Grey Coals	HW1265	\$66.00
Black Coals	HW1267	\$66.00

ORDER 2 IF BEING USED WITHOUT A LOGSET

Optional components:

DELRAY UNIVERSAL ACCESSORIES

Direct Vent Adapter to 5" B-vent	BVK35	\$274.00
DRSQ38 1" Adjustable Trim Kit	DRSQ38	\$144.00
DRSQ38 1" Adjustable Trim Kit [extra deep]	DRSQ38-2	\$204.00

Standard kit for up to 11/16" deep facing materials

Extra deep kit for 1/2"-2" deep facing materials

DELRAY FULL LOAD ACCESSORIES

Wall Mounted Proflame 2 Remote	REC1550	\$334.00
Proflame 2 WiFi Dongle	SIT-WIFI	\$244.00

DELRAY BASIC ACCESSORIES

Battery Back-up	AF40BP	\$27.00
Remote [on/off only]	RX40	\$329.00
Remote [on/off + thermostatic control]	RX60	\$419.00
DelRay Square Fan Kit	DRFK2	\$399.00
DRSQ38 micro mesh Screen	SCRIDRSQ38	\$389.00



DelRay Square 42"

NOTES:
For optional glass media SKU and price (firestones, firebeads, fireglass) please refer to media page. The quantity of bags required can be found in the unit description.

MUST ORDER: Fireplace Media System

A Select the fireplace:

DELRAY SQUARE 42 BASIC

32,500 BTU NG model with Proflame 2 BASIC IPI 5"/8" venting
MUST ORDER MEDIA SYSTEM TO COMPLETE INSTALLATION (If using glass media, 7lbs. are required)

DelRay Square 42 Basic	NG	DRSQ42NI	\$4,879.00
NG to LP Conversion Kit	LP	GCA026	\$109.00

Shipping Weight: 242lb Length: 55" Width: 24" Height: 46"

DELRAY SQUARE 42 FULL LOAD

32,500 BTU NG model equipped with Proflame 2 IPI, multi-function remote control, remote Hi-Lo flame control, remote controlled fans, micro mesh screen, battery backup, halogen downlighting, 5"/8" venting
MUST ORDER MEDIA SYSTEM TO COMPLETE INSTALLATION (If using glass media, 7lbs. are required)

DelRay Square 42 Full Load	NG	DRSQ42NI-2	\$5,669.00
NG to LP Conversion Kit	LP	GCA027	\$109.00

Shipping Weight: 257lb Length: 55" Width: 24" Height: 46"

B Select a media system:

DELRAY TRADITIONAL SETS

Driftwood	LGSDW4	\$285.00
Birch	LGsBI4	\$285.00
Split Oak	LGSSO4	\$285.00

All traditional scenes come with a logset and Black Coal fuelbed and embers

DELRAY CONTEMPORARY SCENES

DRSQ42 Winter Contemporary Scene	CSW42	\$289.00
DRSQ42 Twilight Contemporary Scene	CST42	\$289.00
DRSQ42 Beach Contemporary Scene	CSB42	\$389.00

MEDIA OPTIONS

Speckled Stones 250pc	RR250SS	\$444.00
Red Coals	HW1266	\$66.00
Grey Coals	HW1265	\$66.00
Black Coals	HW1267	\$66.00

ORDER 3 IF BEING USED WITHOUT A LOGSET

Optional liners:

DELRAY LINERS

Grey Herringbone Brick	DRSQBK42GH	\$349.00
Ash Fluted Brick	DRSQBK42AF	\$349.00
Grey LedgeStone	DRSQBK42GL	\$349.00
Vintage Brown Brick	DRSQBK42VB	\$349.00
Tan Brick	DRSQBK42TB	\$349.00
Red Brick	DRSQBK42RB	\$349.00
Black Reflective Glass	RBGDRSQ42	\$579.00

Fireplaces come with a satin black painted finish and do not require a liner

Optional components:

DELRAY UNIVERSAL ACCESSORIES

DRSQ42 1" Adjustable Trim Kit	DRSQT42	\$159.00
DRSQ42 1" Adjustable Trim Kit [extra deep]	DRSQT42-2	\$224.00

Standard kit for up to 11/16" deep facing materials
Extra deep kit for 1 1/2"-2" deep facing materials

DELRAY FULL LOAD ACCESSORIES

Wall Mounted Proflame 2 Remote	REC1550	\$334.00
Proflame 2 WiFi Dongle	SIT-WIFI	\$244.00

DELRAY BASIC ACCESSORIES

Battery Back-up	AF40BP	\$27.00
Remote [on/off only]	RX40	\$329.00
Remote [on/off + thermostatic control]	RX60	\$419.00
DelRay Square Fan Kit	DRFK2	\$399.00
DRSQ42 Micro Mesh Screen	SCRIDRSQ42	\$419.00

Ω Mobile home compatible units can be ordered by adding an (MH) to the end of the unit order code



POWERVENTING

DRSQ42
DRSQ46

NOT COMPATIBLE

NOT COMPATIBLE

COMPATIBLE

COMPATIBLE
ALTERNATIVE

COMPATIBLE

BETTER OPTION:
COOL WALL
RELEASE

DelRay Square 46"

NOTES:
For optional glass media SKU and price (firestones, firebeads, fireglass) please refer to media page. The quantity of bags required can be found in the unit description.

NOTES:
DelRay fireplaces have the installation feature of opening the venting ports and ventilating the chase, known as "Cool Wall Release". This allows for the usage of combustible facing material, as well as negating the need for the included cement board and stud heat deflector. Components like liners, plenums, and louvers that are part of a "Cool Wall Advantage" kit are not required but are a compatible alternative.

MUST ORDER: Fireplace Media System

A Select the fireplace:

DELRAY SQUARE 46 BASIC

40,000 BTU NG model with Proflame 2 BASIC IPI 5"/8" venting
MUST ORDER MEDIA SYSTEM TO COMPLETE INSTALLATION (If using glass media, 8lbs. are required)

DelRay Square 46 Basic	NG	DRSQ46NI	\$5,349.00
NG to LP Conversion Kit	LP	GCA023	\$119.00

Shipping Weight: 279lb Length: 55½" Width: 24½" Height: 46"

DELRAY SQUARE 46 FULL LOAD

40,000 BTU NG model equipped with Proflame 2 IPI, multi-function remote control, remote Hi-Lo flame control, remote controlled fans, micro mesh screen, battery backup, halogen downlighting, 5"/8" venting
MUST ORDER MEDIA SYSTEM TO COMPLETE INSTALLATION (If using glass media, 8lbs. are required)

DelRay Square 46 Full Load	NG	DRSQ46NI-2	\$6,209.00
NG to LP Conversion Kit	LP	GCA024	\$119.00

Shipping Weight: 289lb Length: 55½" Width: 24½" Height: 46"

B Select a media system:

DELRAY TRADITIONAL SETS

Driftwood	LGSDW4	\$285.00
Birch	LGSBI4	\$285.00
Split Oak	LGSSO4	\$285.00

All traditional scenes come with a logset and Black Coal fuelbed and embers

DELRAY CONTEMPORARY SCENES

DRSQ46 Winter Contemporary Scene	CSW46	\$354.00
DRSQ46 Twilight Contemporary Scene	CST46	\$354.00
DRSQ46 Beach Contemporary Scene	CSB46	\$449.00

MEDIA OPTIONS

Speckled Stones 300pc	RR300SS	\$519.00
Red Coals	HW1266	\$66.00
Grey Coals	HW1265	\$66.00
Black Coals	HW1267	\$66.00

ORDER 4 IF BEING USED WITHOUT A LOGSET

Optional liners:

DELRAY LINERS

Grey Herringbone Brick	DRSQBK46GH	\$384.00
Ash Fluted Brick	DRSQBK46AF	\$384.00
Grey LedgeStone	DRSQBK46GL	\$384.00
Vintage Brown Brick	DRSQBK46VB	\$384.00
Tan Brick	DRSQBK46TB	\$384.00
Red Brick	DRSQBK46RB	\$384.00
Black Reflective Glass	RBGDRSQ46	\$639.00

Fireplaces come with a satin black painted finish and do not require a liner

Optional components:

DELRAY UNIVERSAL ACCESSORIES

DRSQ46 1" Adjustable Trim Kit	DRSQT46	\$174.00
DRSQ46 1" Adjustable Trim Kit [extra deep]	DRSQT46-2	\$244.00

Standard kit for up to 11/16" deep facing materials

Extra deep kit for 1½"-2" deep facing materials

DELRAY FULL LOAD ACCESSORIES

Wall Mounted Proflame 2 Remote	REC1550	\$334.00
Proflame 2 WiFi Dongle	SIT-WIFI	\$244.00

DELRAY BASIC ACCESSORIES

Battery Back-up	AF40BP	\$27.00
Remote [on/off only]	RX40	\$329.00
Remote [on/off + thermostatic control]	RX60	\$419.00
DelRay Square Fan Kit	DRFK2	\$399.00
DRSQ46 Micro Mesh Screen	SCRIDRSQ46	\$459.00

Ω Mobile home compatible units can be ordered by adding an (MH) to the end of the unit order code



PAGE IS INTENTIONALLY LEFT BLANK FOR PRINTING PURPOSES
(INSERT SECTION TAB HERE)

PAGE IS INTENTIONALLY LEFT BLANK FOR PRINTING PURPOSES
(INSERT SECTION TAB HERE)



Distinction Single Sided

NOTES:
For optional glass media SKU and price (firestones, firebeads, fireglass) please refer to media page. The quantity of bags required can be found in the unit description.

MUST ORDER: Fireplace

A Select the fireplace:

D3615NI-2

35,000 BTU NG/LP Model with Proflame 2 IPI 5”/8” venting. Supplied with 6 lbs. of Ice fireglass. [HW1157]

Distinction 36	NG	D3615NI-2	\$5,779.00
NG to LP Conversion Kit	LP	GCA015	\$149.00
5”/8” to 4”/7” Reducer 10” Length [male/female]	PVA5487		\$129.00
Shipping Weight: 460lb Length: 60” Width: 31” Height: 52”			

D4815NI-2

40,000 BTU NG/LP Model with Proflame 2 IPI 5”/8” venting. Supplied with 9 lbs. of Ice fireglass. [HW1157]

Distinction 48	NG	D4815NI-2	\$6,829.00
NG to LP Conversion Kit	LP	GCA017	\$149.00
5”/8” to 4”/7” Reducer 10” Length [male/female]	PVA5487		\$129.00
Shipping Weight: 556lb Length: 72” Width: 31” Height: 52”			

D6315NI-2

50,000 BTU NG/LP Model with Proflame 2 IPI 5”/8” venting. Supplied with 12 lbs. of Ice fireglass. [HW1157]

Distinction 63	NG	D6315NI-2	\$12,299.00
NG to LP Conversion Kit	LP	GCA009	\$149.00
Shipping Weight: 516lb Length: 82½” Width: 23” Height: 45”			

D7215NI-2

57,000 BTU NG/LP Model with Proflame 2 IPI 5”/8” venting. Supplied with 15 lbs. of Ice fireglass. [HW1157]

Distinction 72	NG	D7215NI-2	\$13,739.00
NG to LP Conversion Kit	LP	GCA013	\$149.00
Shipping Weight: 780lb Length: 95½” Width: 32” Height: 53½”			

Optional components

Wall Mounted Proflame 2 Remote	REC1550	\$334.00
Proflame 2 WiFi Dongle	SIT-WIFI	\$244.00

Optional decorative media

36 MEDIA

Speckled Stones 150pc	RR150SS	\$244.00
Driftwood Kit Small	LGS59	\$284.00
Driftwood Kit	LGS60	\$309.00
D3615 Ash Fluted Liner	DBK36AF	\$259.00
D3615 Tuscan Fluted Liner	DBK36TF	\$259.00
D3613 1” Adjustable Trim Kit	DLT36	\$139.00
D3613 1” Adjustable Trim Kit [extra deep]	DLT36-2	\$154.00

48 MEDIA

Speckled Stones 200pc	RR200SS	\$354.00
Driftwood Kit Small	LGS59	\$284.00
Driftwood Kit Large	LGS57	\$294.00
Driftwood Kit	LGS61	\$224.00
D4815 Ash Fluted Liner	DBK48AF	\$329.00
D4815 Tuscan Fluted Liner	DBK48TF	\$329.00
D4813 1” Adjustable Trim Kit	DLT48	\$164.00
D4813 1” Adjustable Trim Kit [extra deep]	DLT48-2	\$179.00

63 MEDIA

Speckled Stones 450pc	RR450SS	\$767.00
Driftwood Kit Small	LGS59	\$284.00
Driftwood Kit Medium	LGS58	\$344.00
D6315 Ash Fluted Liner	DBK63AF	\$399.00
D6315 Tuscan Fluted Liner	DBK63TF	\$399.00
D6313 1” Adjustable Trim Kit	DLT63	\$194.00
D6313 1” Adjustable Trim Kit [extra deep]	DLT63-2	\$209.00

72 MEDIA

Speckled Stones 450pc	RR450SS	\$767.00
Driftwood Kit Small	LGS59	\$284.00
Driftwood Kit Large	LGS57	\$294.00
Driftwood Kit Medium	LGS58	\$344.00
D7215 Ash Fluted Liner	DBK72AF	\$444.00
D7215 Tuscan Fluted Liner	DBK72TF	\$444.00
D7213 1” Adjustable Trim Kit	DLT72	\$209.00
D7213 1” Adjustable Trim Kit [extra deep]	DLT72-2	\$234.00



POWERVENTING
D3615 REDUCED

COMPATIBLE

NOT COMPATIBLE

NOT COMPATIBLE

COMPATIBLE

COMPATIBLE

COMPATIBLE



Distinction See Through

NOTES:
For optional glass media SKU and price (firestones, firebeads, fireglass) please refer to media page. The quantity of bags required can be found in the unit description.

MUST ORDER: Fireplace

A Select the fireplace:

D3615STNI-2

35,000 BTU NG/LP Model with Proflame 2 IPI 5”/8” venting. Supplied with 6 lbs. of Ice fireglass. [HW1157]

Distinction 36 See Through	NG	D3615STNI-2	\$6,589.00
NG to LP Conversion Kit	LP	GCA015	\$149.00
5”/8” to 4”/7” Reducer 10” Length [male/female]	PVA5487		\$129.00
Shipping Weight: 460lb Length: 60” Width: 31” Height: 52”			

D4815STNI-2

40,000 BTU NG/LP Model with Proflame 2 IPI 5”/8” venting. Supplied with 9 lbs. of Ice fireglass. [HW1157]

Distinction 48 See Through	NG	D4815STNI-2	\$8,269.00
NG to LP Conversion Kit	LP	GCA017	\$149.00
5”/8” to 4”/7” Reducer 10” Length [male/female]	PVA5487		\$129.00
Shipping Weight: 556lb Length: 72” Width: 31” Height: 52”			

D6315STNI-2

50,000 BTU NG/LP Model with Proflame 2 IPI 5”/8” venting. Supplied with 12 lbs. of Ice fireglass. [HW1157]

Distinction 63 See Through	NG	D6315STNI-2	\$15,199.00
NG to LP Conversion Kit	LP	GCA009	\$149.00
Shipping Weight: 516lb Length: 82½” Width: 23” Height: 45”			

D7215STNI-2

57,000 BTU NG/LP Model with Proflame 2 IPI 5”/8” venting. Supplied with 15 lbs. of Ice fireglass. [HW1157]

Distinction 72 See Through	NG	D7215STNI-2	\$16,799.00
NG to LP Conversion Kit	LP	GCA013	\$149.00
Shipping Weight: 780lb Length: 95½” Width: 32” Height: 53½”			

Optional components

Wall Mounted Proflame 2 Remote	REC1550	\$334.00
Proflame 2 WiFi Dongle	SIT-WIFI	\$244.00

Optional decorative media

36 MEDIA

Speckled Stones 150pc	RR150SS	\$244.00
Driftwood Kit Small	LGS59	\$284.00
Driftwood Kit	LGS60	\$309.00
ST Ash Fluted Liner	DBKAFST	\$88.00
ST Tuscan Fluted Liner	DBKTFST	\$87.00
D3613 1” Adjustable Trim Kit	DLT36	\$139.00
D3613 1” Adjustable Trim Kit [extra deep]	DLT36-2	\$154.00

ORDER BOTH

48 MEDIA

Speckled Stones 200pc	RR200SS	\$354.00
Driftwood Kit Small	LGS59	\$284.00
Driftwood Kit Large	LGS57	\$294.00
Driftwood Kit	LGS61	\$224.00
ST Ash Fluted Liner	DBKAFST	\$88.00
ST Tuscan Fluted Liner	DBKTFST	\$87.00
D4813 1” Adjustable Trim Kit	DLT48	\$164.00
D4813 1” Adjustable Trim Kit [extra deep]	DLT48-2	\$179.00

ORDER ALL

63 MEDIA

Speckled Stones 450pc	RR450SS	\$767.00
Driftwood Kit Small	LGS59	\$284.00
Driftwood Kit Medium	LGS58	\$344.00
D6315ST Ash Fluted Liner	DBK63AFST	\$104.00
D6315ST Tuscan Fluted Liner	DBK63TFST	\$102.00
D6313 1” Adjustable Trim Kit	DLT63	\$194.00
D6313 1” Adjustable Trim Kit [extra deep]	DLT63-2	\$209.00

ORDER BOTH

72 MEDIA

Speckled Stones 450pc	RR450SS	\$767.00
Driftwood Kit Small	LGS59	\$284.00
Driftwood Kit Large	LGS57	\$294.00
Driftwood Kit Medium	LGS58	\$344.00
ST Ash Fluted Liner	DBKAFST	\$88.00
ST Tuscan Fluted Liner	DBKTFST	\$87.00
D7213 1” Adjustable Trim Kit	DLT72	\$209.00
D7213 1” Adjustable Trim Kit [extra deep]	DLT72-2	\$234.00

ORDER ALL

PAGE IS INTENTIONALLY LEFT BLANK FOR PRINTING PURPOSES
(INSERT SECTION TAB HERE)

PAGE IS INTENTIONALLY LEFT BLANK FOR PRINTING PURPOSES
(INSERT SECTION TAB HERE)



NEW PRODUCT

Paragon 36"

Paragon - Direct Vent Pro® 5/8 Venting

Paragon fireplaces come fitted with a Direct Vent Pro® 5/8 universal collar. Montigo venting and power vents are not compatible with the paragon series.



MUST ORDER: Fireplace Media System

A Select the fireplace:

PARAGON 36

40,000/40,000 BTU NG model with Proflame 2 IPI, 5/8 venting. Includes Micro mesh screen, Cement Board, Multi-Function remote to control the front and rear burner, 6-step variable flame height, Independent Rear burner on/off (70% turn down), Accent lighting on/off with 6-step dimming, Optional Dual fans on/off with 6-speed settings. TruFlame Technology Catalyst allows large flame, extensive ember bed and clean burn.

Paragon Clean-Face Direct-Vent Fireplace, 36, NG	NG	DVCT36CBP95N	\$5,899.00
NG to Propane Conversion Kit	LP	37506	\$97.00

B Select a logset:

LOGSETS

Birch logset	LS36CBB	\$719.00
Traditional logset	LS36TINF	\$559.00

C Select a liner:

LINERS

Grey Herringbone Brick	DVP36CPGH	\$499.00
Vintage Brown Brick	DVP36CPVB	\$519.00
Black Porcelain with Matte Black Ceiling & Floor	DVP36CPKR	\$959.00

Optional components:

FORGED IRON FRONTS (FRAMES)

Forged Iron Frame, Black	DFF36BL	\$999.00
Forged Iron Frame, Distressed Pewter	DFF36FPD	\$1,339.00
Forged Iron Frame, Oil-Rubbed Bronze	DFF36BZT	\$1,339.00

BEVELED FRONTS (FRAMES)

Textured Black, Beveled Frame, 1.5-in	DF362BLX	\$1,099.00
Oil-Rubbed Bronze, Beveled Frame, 1.5-in	DF362BZT	\$1,189.00
Brushed Nickel, Beveled Frame, 1.5-in	DF362CNB	\$1,189.00

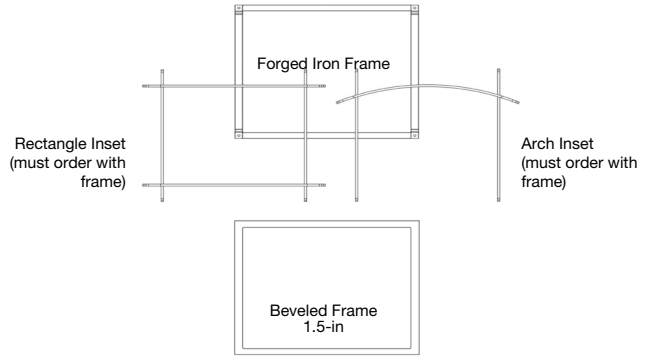

FRONTS (INSETS)

Forged Iron Inset, Arch, Black	DFF36RBL	\$389.00
Forged Iron Inset, Rectangle, Black	DFF36CBL	\$369.00
Forged Iron Inset, Arch, Distressed Pewter	DFF36RPD	\$509.00
Forged Iron Inset, Rectangle, Distressed Pewter	DFF36CPD	\$489.00
Forged Iron Inset, Arch, Oil-Rubbed Bronze	DFF36RBZT	\$509.00
Forged Iron Inset, Rectangle, Oil-Rubbed Bronze	DFF36FBZT	\$489.00

HEAT MANAGEMENT

Gravity Heat Management [Includes 36" plenum and 10' flex]	HMGW36	\$639.00
External Forced Air Heat Management [Requires flex kit]	HMFA	\$999.00
Flex Vent Kit for Forced Air Kit [25' flex and clamps]	SD6DFA25	\$319.00

ACCESSORIES

Twin Blower, Auto Variable Speed	FBB21	\$419.00
Wall Mounted Proflame 2 Remote	REC1550	\$334.00

POWER VENTS WALL AND ROOF

Horizontal Power Vent Termination for use on 90 Series DV Fireplaces [Req Wire Harness and SD58DVAX46 Vent Adaptor]	DVKPM	\$1,168.00
Vertical Conversion Kit [fits Power Vent Module DVKPM]	DVKCV	\$348.00
DV Vent Pipe Reducer, 5 x 8 to 4 x 6 5/8 [attach to top of fireplace only]	SD58DVAX46	\$129.00

POWER VENT WIRE HARNESS

Wire Harness - 25'	WHP25	\$749.00
Wire Harness - 50'	WHP50	\$849.00
Wire Harness - 75'	WHP75	\$899.00
Wire Harness - 100'	WHP100	\$949.00



NOT COMPATIBLE

NOT COMPATIBLE

NOT COMPATIBLE

NOT COMPATIBLE

NOT COMPATIBLE

NOT COMPATIBLE

NOT COMPATIBLE

USE DURAVENT 5/8 OR EQUIVALENT

USE DVKPM

NEW PRODUCT

Paragon 40"

Paragon - Direct Vent Pro® 5/8 Venting

Paragon fireplaces come fitted with a Direct Vent Pro® 5/8 universal collar. Montigo venting and power vents are not compatible with the paragon series.

DIRECT VENT PRO® 5/8

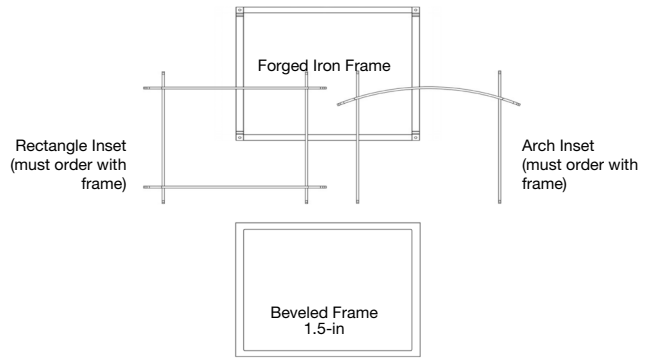

MUST ORDER: **F** Fireplace **B** Media System

A Select the fireplace:

PARAGON 40

47,500/45,000 BTU NG model with Proflame 2 IPI, 5/8 venting. Includes Micro mesh screen, Cement Board, Multi-Function remote to control the front and rear burner, 6-step variable flame height, Independent Rear burner on/off (70% turn down), Accent lighting on/off with 6-step dimming, Optional Dual fans on/off with 6-speed settings. TruFlame Technology Catalyst allows large flame, extensive ember bed and clean burn

Paragon Clean-Face Direct-Vent Fireplace, 40, NG	NG	DVCT40CBP95N	\$6,329.00
NG to Propane Conversion Kit	LP	36884	\$97.00

B Select a logset:

LOGSETS

Birch logset	LS40CBB	\$829.00
Traditional logset	LS40TINF	\$569.00

C Select a liner:

LINERS

Vintage Brown Brick	DVP40PVB	\$559.00
Black Porcelain w/Matte Ceiling & Floor	DVP40PKR	\$1,029.00

Optional components:

FORGED IRON FRONTS (FRAMES)

Forged Iron Frame, Black	DFF40BL	\$1,249.00
Forged Iron Frame, Distressed Pewter	DFF40FPD	\$1,459.00
Forged Iron Frame, Oil-Rubbed Bronze	DFF40BZT	\$1,459.00

BEVELED FRONTS (FRAMES)

Textured Black, Beveled Frame, 1.5-in	DF402BLX	\$1,159.00
Oil-Rubbed Bronze, Beveled Frame, 1.5-in	DF402BZT	\$1,239.00
Brushed Nickel, Beveled Frame, 1.5-in	DF402NB	\$1,239.00

FRONTS (INSETS)

Forged Iron Inset, Arch, Black	DFF40RBL	\$409.00
Forged Iron Inset, Rectangle, Black	DFF40CBL	\$389.00
Forged Iron Inset, Arch, Distressed Pewter	DFF40FPD	\$519.00
Forged Iron Inset, Rectangle, Distressed Pewter	DFF40CPD	\$499.00
Forged Iron Inset, Arch, Oil-Rubbed Bronze	DFF40RBZT	\$519.00
Forged Iron Inset, Rectangle, Oil-Rubbed Bronze	DFF40FBZT	\$499.00

HEAT MANAGEMENT

Gravity Heat Management [Includes 36" plenum and 10' flex]	HMGW36	\$639.00
External Forced Air Heat Management [Requires flex kit]	HMFA	\$999.00
Flex Vent Kit for Forced Air Kit [25' flex and clamps]	SD6DFA25	\$319.00

ACCESSORIES

Twin Blower, Auto Variable Speed	FBB21	\$419.00
Wall Mounted Proflame 2 Remote	REC1550	\$334.00

POWER VENTS WALL AND ROOF

Horizontal Power Vent Termination for use on 90 Series DV Fireplaces [Req Wire Harness and SD58DVAX46 Vent Adaptor]	DVKPM	\$1,168.00
Vertical Conversion Kit [fits Power Vent Module DVKPM]	DVKCV	\$348.00
DV Vent Pipe Reducer, 5 x 8 to 4 x 6 5/8 [attach to top of fireplace only]	SD58DVAX46	\$129.00

POWER VENT WIRE HARNESS

Wire Harness - 25'	WHP25	\$749.00
Wire Harness - 50'	WHP50	\$849.00
Wire Harness - 75'	WHP75	\$899.00
Wire Harness - 100'	WHP100	\$949.00



NEW PRODUCT

Paragon See through 40"

Paragon - Direct Vent Pro® 5/8 Venting

Paragon fireplaces come fitted with a Direct Vent Pro® 5/8 universal collar. Montigo venting and power vents are not compatible with the paragon series.



MUST ORDER: Fireplace Media System

A Select the fireplace:

PARAGON 40

60,500/55,000 BTU NG model with Proflame 2 IPI, 5/8 venting. Includes Micro mesh screen, Cement Board, Multi-Function remote to control the front and rear burner, 6-step variable flame height, Independent Rear burner on/off (70% turn down), Accent lighting on/off with 6-step dimming, Optional Dual fans on/off with 6-speed settings. TruFlame Technology Catalyst allows large flame, extensive ember bed and clean burn

Paragon Clean-Face Direct-Vent See-Through Fireplace, 40, NG	NG	DVCT40CSP95N	\$9,199.00
NG to Propane Conversion Kit	LP	40636	\$97.00

B Select a logset:

LOGSETS

See-Through Traditional logset	LS40STB	\$889.00
--------------------------------	---------	----------

C Select a liner:

LINERS

Vintage Brown Brick	DVP40PSVB	\$429.00
Black Reflective w/Matte Ceiling & Floor	DVP40PSKR	\$749.00
Grey Herringbone Brick	DVP40PSGH	\$439.00

Optional components:

FORGED IRON FRONTS (FRAMES)

Forged Iron Frame, Black	DFF40BL	\$1,249.00
Forged Iron Frame, Distressed Pewter	DFF40FPD	\$1,459.00
Forged Iron Frame, Oil-Rubbed Bronze	DFF40BZT	\$1,459.00

BEVELED FRONTS (FRAMES)

Textured Black, Beveled Frame, 1.5-in	DF402BLX	\$1,159.00
Oil-Rubbed Bronze, Beveled Frame, 1.5-in	DF402BZT	\$1,239.00
Brushed Nickel, Beveled Frame, 1.5-in	DF402NB	\$1,239.00

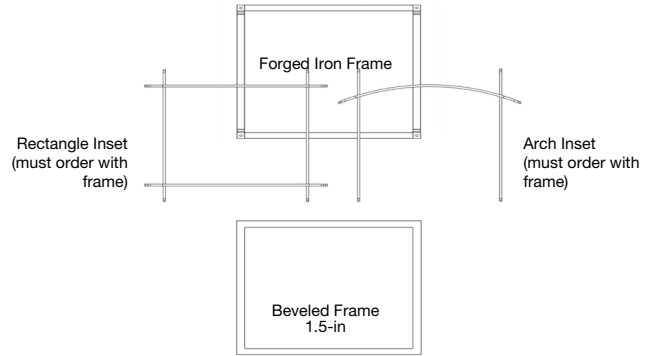

FRONTS (INSETS)

Forged Iron Inset, Arch, Black	DFF40RBL	\$409.00
Forged Iron Inset, Rectangle, Black	DFF40CBL	\$389.00
Forged Iron Inset, Arch, Distressed Pewter	DFF40FPD	\$519.00
Forged Iron Inset, Rectangle, Distressed Pewter	DFF40CPD	\$499.00
Forged Iron Inset, Arch, Oil-Rubbed Bronze	DFF40RBZT	\$519.00
Forged Iron Inset, Rectangle, Oil-Rubbed Bronze	DFF40FBZT	\$499.00

HEAT MANAGEMENT

Gravity Heat Management [Includes 36" plenum and 10' flex]	HMGW36	\$639.00
External Forced Air Heat Management [Requires flex kit]	HMFA	\$999.00
Flex Vent Kit for Forced Air Kit [25' flex and clamps]	SD6DFA25	\$319.00

INDOOR-OUTDOOR KIT

Frame, Stainless Steel, for Exterior Installation	DFED409SS	\$2,849.00
---	-----------	------------

POWER VENTS WALL AND ROOF

Horizontal Power Vent Termination for use on 90 Series DV Fireplaces [Req Wire Harness and SD58DVAX46 Vent Adaptor]	DVKPM	\$1,168.00
Vertical Conversion Kit [fits Power Vent Module DVKPM]	DVKCV	\$348.00
DV Vent Pipe Reducer, 5 x 8 to 4 x 6 5/8 [attach to top of fireplace only]	SD58DVAX46	\$129.00

POWER VENT WIRE HARNESS

Wire Harness - 25'	WHP25	\$749.00
Wire Harness - 50'	WHP50	\$849.00
Wire Harness - 75'	WHP75	\$899.00
Wire Harness - 100'	WHP100	\$949.00



NOT COMPATIBLE NOT COMPATIBLE NOT COMPATIBLE NOT COMPATIBLE NOT COMPATIBLE NOT COMPATIBLE NOT COMPATIBLE
 USE DURAVENT 5/8 OR EQUIVALENT USE DVKPM



NEW PRODUCT
Paragon 50"

Paragon - Direct Vent Pro® 5/8 Venting
 Paragon fireplaces come fitted with a Direct Vent Pro® 5/8 universal collar. Montigo venting and power vents are not compatible with the paragon series.

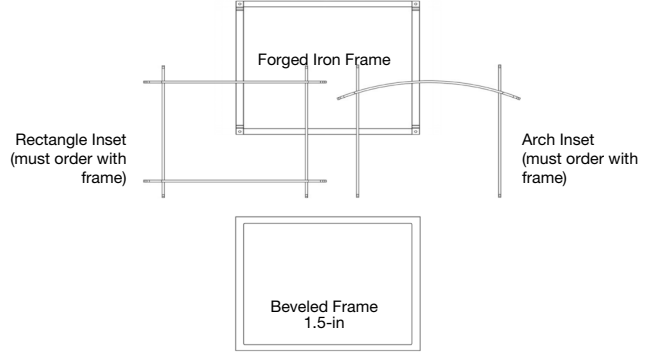

MUST ORDER: **A** Fireplace **B** Media System

A Select the fireplace:

PARAGON 50

56,500/55,000 BTU NG model with Proflame 2 IPI, 5/8 venting. Includes Micro mesh screen, Cement Board, Multi-Function remote to control the front and rear burner, 6-step variable flame height, Independent Rear burner on/off (70% turn down), Accent lighting on/off with 6-step dimming, Optional Dual fans on/off with 6-speed settings
 TruFlame Technology Catalyst allows large flame, extensive ember bed and clean burn

Paragon Clean-Face Direct-Vent Fireplace, 50, NG	NG	DVCT50CBP95N	\$8,649.00
NG to Propane Conversion Kit	LP	38226	\$97.00

B Select a logset:

LOGSETS

50" Traditional logset	LS50TINF	\$979.00
Birch logset	LS50CBB	\$899.00

C Select a liner:

LINERS

Vintage Brown Brick	DVP50CPVB	\$749.00
Black Porcelain w/Matte Ceiling & Floor	DVP50PKR	\$1,259.00
Grey Herringbone Brick	DVP50CPGH	\$749.00

Optional components:

FORGED IRON FRONTS (FRAMES)

Forged Iron Frame, Black	DFF50BL	\$1,359.00
Forged Iron Frame, Distressed Pewter	DFF50FPD	\$1,529.00
Forged Iron Frame, Oil-Rubbed Bronze	DFF50BZT	\$1,529.00

BEVELED FRONTS (FRAMES)

Textured Black, Beveled Frame, 1.5-in	DF502BLX	\$1,299.00
Oil-Rubbed Bronze, Beveled Frame, 1.5-in	DF502BZT	\$1,569.00
Brushed Nickel, Beveled Frame, 1.5-in	DF502NB	\$1,569.00

FRONTS (INSETS)

Forged Iron Inset, Arch, Black	DFF50RBL	\$559.00
Forged Iron Inset, Rectangle, Black	DFF50CBL	\$539.00
Forged Iron Inset, Arch, Distressed Pewter	DFF50RPD	\$629.00
Forged Iron Inset, Rectangle, Distressed Pewter	DFF50CPD	\$629.00
Forged Iron Inset, Arch, Oil-Rubbed Bronze	DFF50RBZT	\$629.00
Forged Iron Inset, Rectangle, Oil-Rubbed Bronze	DFF50FBZT	\$629.00

HEAT MANAGEMENT

Gravity Heat Management [Includes 48" plenum and 10' flex]	HMGW48	\$689.00
External Forced Air Heat Management [Requires flex kit]	HMFA	\$999.00
Flex Vent Kit for Forced Air Kit [25' flex and clamps]	SD6DFA25	\$319.00

ACCESSORIES

Twin Blower, Auto Variable Speed	FBB21	\$419.00
Wall Mounted Proflame 2 Remote	REC1550	\$334.00

POWER VENTS WALL AND ROOF

Horizontal Power Vent Termination for use on 90 Series DV Fireplaces [Req Wire Harness and SD58DVAX46 Vent Adaptor]	DVKPM	\$1,168.00
Vertical Conversion Kit [fits Power Vent Module DVKPM]	DVKCV	\$348.00
DV Vent Pipe Reducer, 5 x 8 to 4 x 6 5/8 [attach to top of fireplace only]	SD58DVAX46	\$129.00

POWER VENT WIRE HARNESS

Wire Harness - 25'	WHP25	\$749.00
Wire Harness - 50'	WHP50	\$849.00
Wire Harness - 75'	WHP75	\$899.00
Wire Harness - 100'	WHP100	\$949.00

PAGE IS INTENTIONALLY LEFT BLANK FOR PRINTING PURPOSES
(INSERT SECTION TAB HERE)

PAGE IS INTENTIONALLY LEFT BLANK FOR PRINTING PURPOSES
(INSERT SECTION TAB HERE)



Divine See Through

NOTES:

For optional glass media SKU and price (firestones, firebeads, fireglass) please refer to media page. The quantity of bags required can be found in the unit description.

MUST ORDER: Fireplace

A Select the fireplace:

H38FSD** STANDING PILOT

34,000 BTU NG / 32,000 BTU LP Standard model with Hi/Lo Valve. Traditional burner and logset, heritage brick liner, wrought iron grate, manual Hi-Lo flame control

Divine H38 See Through Traditional NG	NG	H38FSDN	\$4,849.00
Divine H38 See Through Traditional LP	LP	H38FSDL	\$4,669.00

Shipping Weight: 282lb Length: 41½" Width: 26½" Height: 44"

H38FSD** ELECTRONIC IGNITION

34,000 BTU NG / 32,000 BTU LP Model equipped with Proflame 2 IPI† Traditional burner and logset, heritage brick liner, wrought iron grate, manual hi-lo flame control

Divine H38 See Through Traditional NG IPI	NG	H38FSDNI	\$5,249.00
Divine H38 See Through Traditional LP IPI	LP	H38FSDLI	\$5,249.00

Shipping Weight: 282lb Length: 41½" Width: 26½" Height: 44"

H42FSD** STANDING PILOT

37,000 BTU NG/LP Standard model with Hi/Lo Valve. Traditional burner and logset, heritage brick liner, wrought iron grate, manual hi-lo flame control

Divine H42 See Through Traditional NG	NG	H42FSDN	\$6,119.00
Divine H42 See Through Traditional LP	LP	H42FSDL	\$6,119.00

Shipping Weight: 317lb Length: 47" Width: 29½" Height: 48½"

H42FSD** ELECTRONIC IGNITION

37,000 BTU NG/LP Model equipped with Proflame 2 IPI† Traditional burner and logset, heritage brick liner, wrought iron grate, manual hi-lo flame control

Divine H42 See Through Traditional NG	NG	H42FSDNI	\$6,409.00
Divine H42 See Through Traditional LP	LP	H42FSDLI	\$6,409.00

Shipping Weight: 317lb Length: 47" Width: 29½" Height: 48½"

Optional components:

SURROUNDS

Divine H38 Satin Black Surround	H38SFPSB	\$759.00
Divine H38 Stainless Surround	H38SFSS	\$1,219.00
Divine H42 Satin Black Surround	H42SFPSB	\$859.00
Divine H42 Stainless Surround	H42SFSS	\$1,265.00

TRADITIONAL TO CONTEMPORARY BURNER KIT

H38FSD Burner Conversion Kit NG [traditional to contemporary] Includes 9lbs. of ice fireglass	RBHL38S17R	\$1,809.00
H38FSD Burner Conversion Kit LP [traditional to contemporary] Includes 9lbs. of ice fireglass	RBHL38S18R	\$2,169.00
H42FSD Burner Conversion Kit NG [traditional to contemporary] Includes 12lbs. of ice fireglass	RBHL42S17R	\$1,869.00
H42FSD Burner Conversion Kit LP [traditional to contemporary] Includes 12lbs. of ice fireglass	RBHL42S18R	\$1,869.00

ELECTRONIC IGNITION ONLY ACCESSORIES

Battery Back-up	AF40BP	\$27.00
Wireless Full Load Remote Control Kit NG	RX100NG	\$564.00
Wireless Full Load Remote Control Kit LP	RX100LP	\$564.00
Wall Mounted Proflame 2 Remote	REC1550	\$334.00
Remote Control Kit - [on/off, thermostatic control, manual override, battery back-up]	PF2RK	\$424.00
Fan Kit (Requires RX100NG or RX100LP)	HFK50R	\$464.00

STANDING PILOT ONLY ACCESSORIES

Remote Fan Control [requires RX82]	RFCB	\$394.00
Remote [on/off only]	RX40	\$329.00
Remote [on/off + thermostatic control]	RX60	\$419.00
Remote Control Kit NG [on/off, thermostatic control, wire harness, flame modulation]	RX82NG	\$724.00
Remote Control Kit LP [on/off, thermostatic control, wire harness, flame modulation]	RX82LP	\$724.00
Fan Kit [2 pc fan kit, manual]	HFK42	\$369.00

† IPI Base Builders System does not include remote control.



POWERVENTING

COMPATIBLE

NOT COMPATIBLE

NOT COMPATIBLE

NOT COMPATIBLE

NOT COMPATIBLE

COMPATIBLE



Divine Pier, Bay, Corner

NOTES:

For optional glass media SKU and price (firestones, firebeads, fireglass) please refer to media page. The quantity of bags required can be found in the unit description.

MUST ORDER: Fireplace

A Select the fireplace:

H38PF*1-2 TRADITIONAL PIER

34,000 BTU NG / 32,000 BTU LP Model with Proflame 2 IPI. Traditional burner and logset, heritage brick liner, wrought iron grate, remote Hi-Lo flame control, multi-function remote control, micro mesh screen, battery backup. No fan options available.

Divine H38 Pier Traditional NG	NG	H38PFNI-2	\$6,579.00
Divine H38 Pier Traditional LP	LP	H38PFLI-2	\$6,579.00

Shipping Weight: 340lb Length: 46" Width: 27" Height: 48"

HL38PF*1-2 CONTEMPORARY PIER

34,000 BTU NG / 32,000 BTU LP linear burner model with Proflame 2 IPI. Contemporary burner with Ice fireglass, remote Hi-Lo flame control, multi-function remote control, micro mesh screen, battery backup. No fan options available. Unit supplied with 15 lbs. of Ice fireglass. [HW1157]

Divine HL38 Pier Contemporary NG	NG	HL38PFNI-2	\$6,579.00
Divine HL38 Pier Contemporary LP	LP	HL38PFLI-2	\$6,449.00

Shipping Weight: 340lb Length: 46" Width: 27" Height: 48"

H38PR*1-2 TRADITIONAL BAY

34,000 BTU NG / 32,000 BTU LP Model equipped with Proflame 2 IPI. Traditional burner and logset, heritage brick liner, wrought iron grate, remote Hi-Lo flame control, multi-function remote control, micro mesh screen, battery backup. No fan options available.

Divine H38 Bay Traditional NG	NG	H38PRNI-2	\$6,579.00
Divine H38 Bay Traditional LP	LP	H38PRLI-2	\$6,579.00

Shipping Weight: 363lb Length: 47" Width: 29" Height: 48"

HL38PR*1-2 CONTEMPORARY BAY

34,000 BTU NG / 32,000 BTU LP linear burner model with Proflame 2 IPI. Contemporary burner with Ice fireglass, remote Hi-Lo flame control, multi-function remote control, micro mesh screen, battery backup. No fan options available. Unit supplied with 15 lbs. of Ice fireglass. [HW1157]

Divine HL38 Bay Contemporary NG	NG	HL38PRNI-2	\$6,579.00
Divine HL38 Bay Contemporary LP	LP	HL38PRLI-2	\$6,579.00

Shipping Weight: 363lb Length: 47" Width: 29" Height: 48"



H38C*1-2 TRADITIONAL CORNER

34,000 BTU NG / 32,000 BTU LP Model equipped with Proflame 2 IPI. Traditional burner and logset, heritage brick liner, wrought iron grate, remote Hi-Lo flame control, multi-function remote control, micro mesh screen, battery backup. No fan options available.

Divine H38 Corner LEFT Traditional NG	NG	H38CLNI-2	\$6,579.00
Divine H38 Corner LEFT Traditional LP	LP	H38CLLI-2	\$6,579.00
Divine H38 Corner RIGHT Traditional NG	NG	H38CRNI-2	\$6,579.00
Divine H38 Corner RIGHT Traditional LP	LP	H38CRLI-2	\$6,579.00

Shipping Weight: 356lb Length: 47" Width: 29" Height: 48"

H38CL*1-2 CONTEMPORARY CORNER

34,000 BTU NG / 32,000 BTU LP Model equipped with Proflame 2 IPI. Contemporary burner with Ice fireglass, remote Hi-Lo flame control, multi-function remote control, micro mesh screen, battery backup. No fan options available. Unit supplied with 15 lbs. of Ice fireglass. [HW1157]

Divine HL38 Corner LEFT Contemporary NG	NG	HL38CLNI-2	\$6,579.00
Divine HL38 Corner LEFT Contemporary LP	LP	HL38CLLI-2	\$6,579.00
Divine HL38 Corner RIGHT Contemporary NG	NG	HL38CRNI-2	\$6,579.00
Divine HL38 Corner RIGHT Contemporary LP	LP	HL38CRLI-2	\$6,579.00

Shipping Weight: 356lb Length: 47" Width: 29" Height: 48"

Optional components:

DIVINE ACCESSORIES

Wall Mounted Proflame 2 Remote	REC1550	\$334.00
Proflame 2 WiFi Dongle	SIT-WIFI	\$244.00

PAGE IS INTENTIONALLY LEFT BLANK FOR PRINTING PURPOSES
(INSERT SECTION TAB HERE)

PAGE IS INTENTIONALLY LEFT BLANK FOR PRINTING PURPOSES
(INSERT SECTION TAB HERE)



Exemplar Single Sided

NOTES:
For optional glass media SKU and price (firestones, firebeads, fireglass) please refer to media page. The quantity of bags required can be found in the unit description.

MUST ORDER: **A** Fireplace, **B** Power vent, **C** Power cord

A Select the fireplace:

R320

50,000 BTU NG / 40,000 BTU LP Model with Honeywell HSI 5 7/8" venting Unit supplied with 9 lbs. of Ice fireglass. [HW1157]

Exemplar R320 NG	NG	R320N	\$8,289.00
Exemplar R320 LP	LP	R320L	\$8,289.00
Shipping Weight: 501lb Length: 61" Width: 36" Height: 54"			

R420

65,000 BTU NG / 55,000 BTU LP Model with Honeywell HSI 5 7/8" venting Unit supplied with 12 lbs. of Ice fireglass. [HW1157]

Exemplar R420 NG	NG	R420N	\$10,779.00
Exemplar R420 LP	LP	R420L	\$10,779.00
Shipping Weight: 602lb Length: 77" Width: 36" Height: 54"			

R520

80,000 BTU NG / 65,000 BTU LP Model with Honeywell HSI 5 7/10" venting Unit supplied with 15 lbs. of Ice fireglass. [HW1157]

Exemplar R520 NG	NG	R520N	\$11,769.00
Exemplar R520 LP	LP	R520L	\$11,769.00
Shipping Weight: 715lb Length: 87" Width: 36" Height: 54"			

R720

100,000 BTU NG / 80,000 BTU LP Model with Honeywell HSI 5 7/10" venting Unit supplied with 27 lbs. of Ice fireglass. [HW1157]

Exemplar R720 NG	NG	R720N	\$13,759.00
Exemplar R720 LP	LP	R720L	\$13,759.00
Shipping Weight: 845lb Length: 111" Width: 36" Height: 54"			

R820

100,000 BTU NG / 80,000 BTU LP Model with Honeywell HSI 5 7/10" venting Unit supplied with 30 lbs. of Ice fireglass. [HW1157]

Exemplar R820 NG	NG	R820N	\$15,459.00
Exemplar R820 LP	LP	R820L	\$15,459.00
Shipping Weight: 927lb Length: 123" Width: 36" Height: 54"			

B Select a power vent:



PVHEX58-300



PVVEX58-300



PVHFL58-300

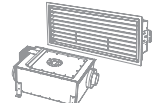

PVHIN58-300-FS WITH TMHIN58-40

POWER VENTS WALL AND ROOF

5 7/8" Wall Mounted Power Vent	PVHEX58-300	\$3,399.00
5 7/10" Wall Mounted Power Vent	PVHEX510-300	\$3,494.00
5 7/8" Roof Mount Power Vent	PVVEX58-300	\$3,749.00
5 7/10" Roof Mount Power Vent	PVVEX510-300	\$3,699.00
5 7/8" Flush Louvered Power Vent	PVHFL58-300	\$3,969.00
5 7/10" Flush Louvered Power Vent	PVHFL510-300	\$3,969.00

POWER VENTS INLINE

5 7/8" Inline Power Vent	PVHIN58-300-FS	\$3,049.00
--------------------------	----------------	------------

POWER VENT TERMINATIONS (FOR INLINE)

5 7/8" Flush Termination for PVHIN58-300-FS	TMHIN58-40	\$1,814.00
5 7/8" Termination for Power Vent	PTO4-PV	\$504.00
5 7/8" Termination Horizontal 4" Length w/ Frame for Power Vent	PTO4F-PV	\$544.00
5 7/8" Stainless Termination for Power Vent	PTO4SS-PV	\$309.00
5 7/8" Stainless Termination w/Frame for Power Vent	PTO4FSS-PV	\$619.00

C Select the required power vent cord:

POWER CORDS

10' Power Vent System Power Cord	EPVH-10	\$129.00
20' Power Vent System Power Cord	EPVH-20	\$179.00
40' Power Vent System Power Cord	EPVH-40	\$279.00
60' Power Vent System Power Cord	EPVH-60	\$379.00
80' Power Vent System Power Cord	EPVH-80	\$479.00
100' Power Vent System Power Cord	EPVH-100	\$579.00

Optional decorative media:

R520 MEDIA

Speckled Stones 500pc	RR500SS	\$839.00
Driftwood Kit Large	LGS57	\$294.00
Driftwood Kit Medium	LGS58	\$344.00

R820 MEDIA

Speckled Stones 600pc	RR600SS	\$1,039.00
Speckled Stones 300pc	RR300SS	\$519.00
Driftwood Kit Large	LGS57	\$294.00
Driftwood Kit Medium	LGS58	\$344.00

REMOTE

Remote Control Kit [on/off only] 110v	RXM40VAC	\$349.00
---------------------------------------	----------	----------



NOT COMPATIBLE

R320-R420

R520-R820

NOT COMPATIBLE

NOT COMPATIBLE

NOT COMPATIBLE

NOT COMPATIBLE



Exemplar See Through

NOTES:
For optional glass media SKU and price (firestones, firebeads, fireglass) please refer to media page. The quantity of bags required can be found in the unit description.

MUST ORDER: Fireplace, Power vent, Power cord

A Select the fireplace:

R320ST

45,000 BTU NG / 42,000 BTU LP Model with Honeywell HSI 5"/8" venting Unit supplied with 15 lbs. of Ice fireglass. [HW1157]

Exemplar R320ST See Through NG	NG	R320STN	\$10,779.00
Exemplar R320ST See Through LP	LP	R320STL	\$10,779.00

Shipping Weight: 601lb Length: 61" Width: 36" Height: 54"

R420ST

55,000 BTU NG/LP Model with Honeywell HSI 5"/8" venting Unit supplied with 21 lbs. of Ice fireglass. [HW1157]

Exemplar R420ST See Through NG	NG	R420STN	\$12,759.00
Exemplar R420ST See Through LP	LP	R420STL	\$12,759.00

Shipping Weight: 625lb Length: 77" Width: 36" Height: 54"

R520ST

80,000 BTU NG/LP Model with Honeywell HSI 5"/10" venting Unit supplied with 24 lbs. of Ice fireglass. [HW1157]

Exemplar R520ST See Through NG	NG	R520STN	\$13,899.00
Exemplar R520ST See Through LP	LP	R520STL	\$13,899.00

Shipping Weight: 755lb Length: 87" Width: 36" Height: 54"

R620ST

100,000 BTU NG/LP Model with Honeywell HSI 5"/10" venting Unit supplied with 27 lbs. of Ice fireglass. [HW1157]

Exemplar R620ST See Through NG	NG	R620STN	\$15,029.00
Exemplar R620ST See Through LP	LP	R620STL	\$15,029.00

Shipping Weight: 941lb Length: 97" Width: 36" Height: 54"

B Select a power vent:



PVHEX58-300



PVVEX58-300



PVHFL58-300

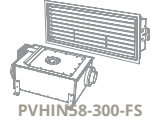

PVHIN58-300-FS WITH TMHIN58-40

POWER VENTS WALL AND ROOF

5"/8" Wall Mounted Power Vent	PVHEX58-300	\$3,399.00
5"/10" Wall Mounted Power Vent	PVHEX510-300	\$3,494.00
5"/8" Roof Mount Power Vent	PVVEX58-300	\$3,749.00
5"/10" Roof Mount Power Vent	PVVEX510-300	\$3,699.00
5"/8" Flush Louvered Power Vent	PVHFL58-300	\$3,969.00
5"/10" Flush Louvered Power Vent	PVHFL510-300	\$3,969.00

POWER VENTS INLINE

5"/8" Inline Power Vent	PVHIN58-300-FS	\$3,049.00
-------------------------	----------------	------------

POWER VENT TERMINATIONS (FOR INLINE)

5"/8" Flush Termination for PVHIN58-300-FS	TMHIN58-40	\$1,814.00
5"/8" Termination for Power Vent	PTO4-PV	\$504.00
5"/8" Termination Horizontal 4" Length w/ Frame for Power Vent	PTO4F-PV	\$544.00
5"/8" Stainless Termination for Power Vent	PTO4SS-PV	\$309.00
5"/8" Stainless Termination w/Frame for Power Vent	PTO4FSS-PV	\$619.00

C Select the required power vent cord:

POWER CORDS

10' Power Vent System Power Cord	EPVH-10	\$129.00
20' Power Vent System Power Cord	EPVH-20	\$179.00
40' Power Vent System Power Cord	EPVH-40	\$279.00
60' Power Vent System Power Cord	EPVH-60	\$379.00
80' Power Vent System Power Cord	EPVH-80	\$479.00
100' Power Vent System Power Cord	EPVH-100	\$579.00

Optional decorative media:

IOSK

R320ST Indoor-Outdoor Seal Kit	IOSK3	\$2,629.00
R420ST Indoor-Outdoor Seal Kit	IOSK4	\$2,799.00
R520ST Indoor-Outdoor Seal Kit	IOSK5	\$2,979.00
R620ST Indoor-Outdoor Seal Kit	IOSK6	\$3,329.00

REMOTE

Remote Control Kit [on/off only] 110v	RXM40VAC	\$349.00
---------------------------------------	----------	----------



Exemplar RP620

NOTES:
For optional glass media SKU and price (firestones, firebeads, fireglass) please refer to media page. The quantity of bags required can be found in the unit description.

MUST ORDER: Fireplace, Power vent, Power cord

A Select the fireplace:

RP620*

75,000 BTU NG / 70,000 BTU LP Model equipped with Honeywell HSI
No Hi-Lo adjustment available. Includes black porcelain liner, halogen
uplighting
Unit supplied with 24 lbs. of Quartz firestones. [HW1106]

Exemplar RP620 NG	NG	RP620N	\$19,909.00
Exemplar RP620 LP	LP	RP620L	\$19,909.00

Shipping Weight: 943lb Length: 98" Width: 36" Height: 54"

B Select a power vent:



PVHEX58-300



PVVEX58-300



PVHFL58-300

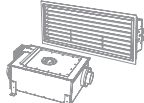

PVHIN58-300-FS
WITH TMHIN58-40

POWER VENTS WALL AND ROOF

5"/8" Wall Mounted Power Vent	PVHEX58-300	\$3,399.00
5"/8" Roof Mount Power Vent	PVVEX58-300	\$3,749.00
5"/8" Flush Louvered Power Vent	PVHFL58-300	\$3,969.00

POWER VENTS INLINE

5"/8" Inline Power Vent	PVHIN58-300-FS	\$3,049.00
-------------------------	----------------	------------

POWER VENT TERMINATIONS (FOR INLINE)

5"/8" Flush Termination for PVHIN58-300-FS	TMHIN58-40	\$1,814.00
5"/8" Termination for Power Vent	PTO4-PV	\$504.00
5"/8" Termination Horizontal 4" Length w/ Frame for Power Vent	PTO4F-PV	\$544.00
5"/8" Stainless Termination for Power Vent	PTO4SS-PV	\$309.00
5"/8" Stainless Termination w/Frame for Power Vent	PTO4FSS-PV	\$619.00

C Select the required power vent cord:

POWER CORDS

10' Power Vent System Power Cord	EPVH-10	\$129.00
20' Power Vent System Power Cord	EPVH-20	\$179.00
40' Power Vent System Power Cord	EPVH-40	\$279.00
60' Power Vent System Power Cord	EPVH-60	\$379.00
80' Power Vent System Power Cord	EPVH-80	\$479.00
100' Power Vent System Power Cord	EPVH-100	\$579.00

Optional decorative media:

RP620 MEDIA

Speckled Stones 600pc	RR600SS	\$1,039.00
Driftwood Logset NG	LGRP6N	\$1,109.00
Driftwood Logset LP	LGRP6L	\$869.00

REMOTE

Remote Control Kit [on/off only] 110v	RXM40VAC	\$349.00
---------------------------------------	----------	----------



NOT COMPATIBLE

RP620 RP424

NOT COMPATIBLE

NOT COMPATIBLE

NOT COMPATIBLE

NOT COMPATIBLE

NOT COMPATIBLE



Exemplar Pier RP424

NOTES:
For optional glass media SKU and price (firestones, firebeads, fireglass) please refer to media page. The quantity of bags required can be found in the unit description.

MUST ORDER: Fireplace, Power vent, Power cord

A Select the fireplace:

RP424*

45,000 BTU NG/LP Model with Honeywell HSI. Includes halogen uplighting, reflective firebox liner. Speckled stones or glass media at no cost. No Hi-Lo adjustment available

Exemplar Pier RP424 NG	NG	RP424PFN	\$20,569.00
Exemplar Pier RP424 LP	LP	RP424PFL	\$20,569.00

Shipping Weight: 877lb Length: 74" Width: 40½" Height: 66"

B Select a power vent:

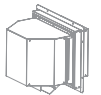

PVHEX58-300



PVVEX58-300



PVHFL58-300

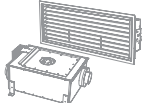

PVHIN58-300-FS
WITH TMHIN58-40

POWER VENTS WALL AND ROOF

5"/8" Wall Mounted Power Vent	PVHEX58-300	\$3,399.00
5"/8" Roof Mount Power Vent	PVVEX58-300	\$3,749.00
5"/8" Flush Louvered Power Vent	PVHFL58-300	\$3,969.00

POWER VENTS INLINE

5"/8" Inline Power Vent	PVHIN58-300-FS	\$3,049.00
-------------------------	----------------	------------

POWER VENT TERMINATIONS (FOR INLINE)

5"/8" Flush Termination for PVHIN58-300-FS	TMHIN58-40	\$1,814.00
5"/8" Termination for Power Vent	PTO4-PV	\$504.00
5"/8" Termination Horizontal 4" Length w/ Frame for Power Vent	PTO4F-PV	\$544.00
5"/8" Stainless Termination for Power Vent	PTO4SS-PV	\$309.00
5"/8" Stainless Termination w/Frame for Power Vent	PTO4FSS-PV	\$619.00

C Select the required power vent cord:

POWER CORDS

10' Power Vent System Power Cord	EPVH-10	\$129.00
20' Power Vent System Power Cord	EPVH-20	\$179.00
40' Power Vent System Power Cord	EPVH-40	\$279.00
60' Power Vent System Power Cord	EPVH-60	\$379.00
80' Power Vent System Power Cord	EPVH-80	\$479.00
100' Power Vent System Power Cord	EPVH-100	\$579.00

D Select the required media:

RP424 MEDIA

Driftwood Kit	LGSPSERIES	\$564.00
Speckled Stones 500pc	RR500SS	N/C
Firestones		N/C
Fireglass		N/C
Firebeads		N/C

Optional components:

REMOTE

Remote Control Kit [on/off only] 110v	RXM40VAC	\$349.00
---------------------------------------	----------	----------



R324 STIO

NOTES:

For optional glass media SKU and price (firestones, firebeads, fireglass) please refer to media page. The quantity of bags required can be found in the unit description.

MUST ORDER: Fireplace

A Select the fireplace:

R324STIO*

50,000 BTU NG/LP Model equipped with Honeywell HSI No Hi-Lo adjustment available
Unit supplied with 21 lbs. of Ice fireglass. [HW1157]

Exemplar II R324 STIO See Through Indoor-Outdoor NG	NG	R324STION	\$10,909.00
Exemplar II R324 STIO See Through Indoor-Outdoor LP	LP	R324STIOL	\$10,909.00

Shipping Weight: 605lb Length: 62" Width: 36" Height: 57"

Optional decorative media:

RP620 MEDIA

Speckled Stones 600pc	RR600SS	\$1,039.00
Driftwood Logset NG	LGRP6N	\$1,109.00
Driftwood Logset LP	LGRP6L	\$869.00

REMOTE

Remote Control Kit [on/off only] 110v	RXM40VAC	\$349.00
---------------------------------------	----------	----------

LINERS

R324STIO Porcelain Panels	PPR324	\$659.00
---------------------------	--------	----------



NOT COMPATIBLE

NOT COMPATIBLE

NOT COMPATIBLE

NOT COMPATIBLE

NOT COMPATIBLE

NOT COMPATIBLE

NOT COMPATIBLE

PAGE IS INTENTIONALLY LEFT BLANK FOR PRINTING PURPOSES
(INSERT SECTION TAB HERE)

PAGE IS INTENTIONALLY LEFT BLANK FOR PRINTING PURPOSES
(INSERT SECTION TAB HERE)



Phenom P38, P42, P52

NOTES:
For optional glass media SKU and price (firestones, firebeads, fireglass) please refer to media page. The quantity of bags required can be found in the unit description.

MUST ORDER: Fireplace

A Select the fireplace:

P38DF*1-2

25,000 BTU NG/LP Model equipped with Proflame 2 IPI 5"/8" venting Multi-function remote control, remote controlled fans, black porcelain liner, halogen uplighting, remote Hi-Lo flame control, battery backup Unit supplied with 9 lbs. of Quartz firestones [HW1106]

Phenom P38 NG	NG	P38DFNI-2	\$6,129.00
Phenom P38 LP	LP	P38DFLI-2	\$6,129.00

Shipping Weight: 197lb Length: 41½" Width: 21½" Height: 33"

P42DF*1-2

32,000 BTU NG/LP Model equipped with Proflame 2 IPI 5"/8" venting Multi-function remote control, remote controlled fans, black porcelain liner, halogen uplighting, remote Hi-Lo flame control, battery backup Unit supplied with 12 lbs. of Quartz firestones [HW1106]

Phenom P42 NG	NG	P42DFNI-2	\$6,829.00
Phenom P42 LP	LP	P42DFLI-2	\$6,829.00

Shipping Weight: 228lb Length: 45" Width: 24" Height: 37½"

P52DF*1-2

40,000 BTU NG/LP Model equipped with Proflame 2 IPI 5"/10" venting Multi-function remote control, remote controlled fans, black porcelain liner, halogen uplighting, remote Hi-Lo flame control, battery backup Unit supplied with 12 lbs. of Quartz firestones [HW1106]

Phenom P52 NG	NG	P52DFNI-2	\$7,699.00
Phenom P52 LP	LP	P52DFLI-2	\$7,699.00

Shipping Weight: 312lb Length: 55½" Width: 26" Height: 39"

Optional decorative media:

38 MEDIA

Speckled Stones 250pc	RR250SS	\$444.00
Driftwood Kit	LGSPSERIES	\$564.00
Phenom 38 Satin Black Surround	P38SFPSB	\$589.00
Phenom 38 Stainless Surround	P38SFSS	\$1,519.00

42 MEDIA

Speckled Stones 300pc	RR300SS	\$519.00
Driftwood Kit	LGSPSERIES	\$564.00
Phenom 42 Satin Black Surround	P42SFPSB	\$714.00
Phenom 42 Stainless Surround	P42SFSS	\$1,289.00

52 MEDIA

Speckled Stones 350pc	RR350SS	\$609.00
Driftwood Kit	LGSPSERIES	\$564.00
Phenom 52 Satin Black Surround	P52SFPSB	\$769.00
Phenom 52 Stainless Surround	P52SFSS	\$1,369.00

Optional components

Wall Mounted Proflame 2 Remote	REC1550	\$334.00
Proflame 2 WiFi Dongle	SIT-WIFI	\$244.00



POWERVENTING

P38-P42

P52

NOT COMPATIBLE

NOT COMPATIBLE

NOT COMPATIBLE

COMPATIBLE



Phenom PL38, PL42, PL52

NOTE:
For optional glass media SKU and price (firestones, firebeads, fireglass) please refer to media page. The quantity of bags required can be found in the unit description.

MUST ORDER: Fireplace

A Select the fireplace:

PL38DF*1

25,000 BTU NG/LP Model equipped with Proflame 2 BASIC IPI 5"/8" venting Unit supplied with 9 lbs. of Ice fireglass. [HW1157]

Phenom PL38 NG	NG	PL38DFNI	\$4,329.00
Phenom PL38 LP	LP	PL38DFLI	\$4,249.00

Shipping Weight: 197lb Length: 41½" Width: 21½" Height: 33"

PL42DF*1

32,000 BTU NG/LP Model equipped with Proflame 2 BASIC IPI 5"/8" venting Unit supplied with 12 lbs. of Ice fireglass. [HW1157]

Phenom PL42 NG	NG	PL42DFNI	\$5,009.00
Phenom PL42 LP	LP	PL42DFLI	\$5,009.00

Shipping Weight: 228lb Length: 45" Width: 24" Height: 37½"

PL52DF*1

40,000 BTU NG/LP Model equipped with Proflame 2 BASIC IPI 5"/10" venting. Unit supplied with 12 lbs. of Ice fireglass. [HW1157]

Phenom PL52 NG	NG	PL52DFNI	\$5,829.00
Phenom PL52 LP	LP	PL52DFLI	\$5,829.00

Shipping Weight: 312lb Length: 55½" Width: 26" Height: 39"

NOTE:
Comes with Proflame 2 BASIC control module, Must upgrade to Proflame 2 system to operate power vents

Optional decorative media:

38 MEDIA

Speckled Stones 250pc	RR250SS	\$444.00
Driftwood Kit	LGSPSERIES	\$564.00
Phenom 38 Satin Black Surround	P38SFPSB	\$589.00
Phenom 38 Stainless Surround	P38SFSS	\$1,519.00
Phenom PL38 Porcelain Panels	PPL38	\$529.00

42 MEDIA

Speckled Stones 300pc	RR300SS	\$519.00
Driftwood Kit	LGSPSERIES	\$564.00
Phenom 42 Satin Black Surround	P42SFPSB	\$714.00
Phenom 42 Stainless Surround	P42SFSS	\$1,289.00
Phenom PL42 Porcelain Panels	PPL42	\$559.00

52 MEDIA

Speckled Stones 350pc	RR350SS	\$609.00
Driftwood Kit	LGSPSERIES	\$564.00
Phenom 52 Satin Black Surround	P52SFPSB	\$769.00
Phenom 52 Stainless Surround	P52SFSS	\$1,369.00
Phenom PL52 Porcelain Panels	PPL52	\$669.00

Optional components

COMPONENTS

Fan Kit [on/off, heat sensor fans, manual fan speed control]	HFK50	\$559.00
--	-------	----------

SIT IPI PROFLAME 2 SYSTEM

Wireless Full Load Remote Control Kit NG	RX200NG	\$829.00
Wireless Full Load Remote Control Kit LP	RX200LP	\$829.00
Wall Mounted Proflame 2 Remote	REC1550	\$334.00
Fan Kit	HFK50R	\$464.00
Battery Back-up	AF40BP	\$27.00



L38FSD, L42FSD, L52FSD

NOTES:
For optional glass media SKU and price (firestones, firebeads, fireglass) please refer to media page. The quantity of bags required can be found in the unit description.

MUST ORDER: Fireplace

A Select the fireplace:

L38FSD* STANDING PILOT

27,000 BTU NG/LP Standard model with linear burner and Hi/Lo Valve Unit supplied with 12 lbs. of Ice fireglass [HW1157]

Phenom L38FSD See Through NG	NG	L38FSDN	\$5,989.00
Phenom L38FSD See Through LP	LP	L38FSDL	\$5,759.00

Shipping Weight: 259lb Length: 46" Width: 27½" Height: 42½"

L38FSD*1 ELECTRONIC IGNITION

27,000 BTU NG/LP Model with linear burner Proflame 2 IPI Unit supplied with 15 lbs. of Ice fireglass [HW1157]

Phenom L38FSD See Through NG	NG	L38FSDNI	\$6,339.00
Phenom L38FSD See Through LP	LP	L38FSDLI	\$6,099.00

Shipping Weight: 275lb Length: 46" Width: 27½" Height: 42½"

L42FSD* STANDING PILOT

34,000 BTU NG/LP Standard model with linear burner and Hi/Lo Valve Unit supplied with 12 lbs. of Ice fireglass. [HW1157]

Phenom L42FSD See Through NG	NG	L42FSDN	\$6,919.00
Phenom L42FSD See Through LP	LP	L42FSDL	\$6,919.00

Shipping Weight: 275lb Length: 46" Width: 27½" Height: 42½"

L42FSD*1 ELECTRONIC IGNITION

34,000 BTU NG/LP Model with linear burner Proflame 2 IPI. Unit supplied with 18 lbs. of Ice fireglass. [HW1157].

Phenom L42FSD See Through NG	NG	L42FSDNI	\$7,499.00
Phenom L42FSD See Through LP	LP	L42FSDLI	\$7,499.00

Shipping Weight: 275lb Length: 46" Width: 27½" Height: 42½"

L52FSD* STANDING PILOT

40,000 BTU NG/LP Standard model with linear burner and Hi/Lo Valve. Unit supplied with 12 lbs. of Ice fireglass. [HW1157].

Phenom L52FSD See Through NG	NG	L52FSDN	\$9,789.00
Phenom L52FSD See Through LP	LP	L52FSDL	\$9,789.00

Shipping Weight: 295lb Length: 63½" Width: 30" Height: 40"

L52FSD*1 ELECTRONIC IGNITION

40,000 BTU NG/LP Model with linear burner Proflame 2 IPI. Unit supplied with 18 lbs. of Ice fireglass. [HW1157]

Phenom L52FSD See Through NG	NG	L52FSDNI	\$10,529.00
Phenom L52FSD See Through LP	LP	L52FSDLI	\$10,529.00

Shipping Weight: 295lb Length: 63½" Width: 30" Height: 40"

Optional decorative media:

MEDIA

Phenom 38 Satin Black Surround	P38SFPBS	\$589.00
Phenom 38 Stainless Surround	P38SFPSS	\$1,519.00
Phenom 42 Satin Black Surround	P42SFPBS	\$714.00
Phenom 42 Stainless Surround	P42SFPSS	\$1,289.00
Phenom 52 Satin Black Surround	P52SFPBS	\$769.00
Phenom 52 Stainless Surround	P52SFPSS	\$1,369.00

Optional components

COMPONENTS

Fan Kit [on/off, heat sensor fans, manual fan speed control]	HFK50	\$559.00
--	-------	----------

NOTE Fans not available on 50" units (standing pilot and electronic ignition)

SIT IPI PROFLAME 2 SYSTEM

Wireless Full Load Remote Control Kit NG	RX100NG	\$564.00
Wireless Full Load Remote Control Kit LP	RX100LP	\$564.00
Wall Mounted Proflame 2 Remote	REC1550	\$334.00
Fan Kit(Requires RX100NG or RX100LP)	HFK50R	\$464.00
Battery Back-up	AF40BP	\$27.00

NOTE Fans not available on 50" units (standing pilot and electronic ignition)

STANDING PILOT ONLY

Remote Fan Control [requires RX82]	RFCB	\$394.00
Remote [on/off only]	RX40	\$329.00
Remote [on/off + thermostatic control]	RX60	\$419.00
Remote Control Kit NG [on/off, thermostatic control, wire harness, flame modulation]	RX82NG	\$724.00
Remote Control Kit LP [on/off, thermostatic control, wire harness, flame modulation]	RX82LP	\$724.00
Fan Kit [2 pc fan kit, manual]	HFK42	\$369.00

NOTE Fans not available on 50" units (standing pilot and electronic ignition)



POWERVENTING

COMPATIBLE

NOT COMPATIBLE

NOT COMPATIBLE

NOT COMPATIBLE

NOT COMPATIBLE

IPI COMPATIBLE

PAGE IS INTENTIONALLY LEFT BLANK FOR PRINTING PURPOSES
(INSERT SECTION TAB HERE)

PAGE IS INTENTIONALLY LEFT BLANK FOR PRINTING PURPOSES
(INSERT SECTION TAB HERE)



Illume 30FID

NOTES:
For optional glass media SKU and price (firestones, firebeads, fireglass) please refer to media page. The quantity of bags required can be found in the unit description.

MUST ORDER: **A** Fireplace, **B** venting, **C** surround, **D** liner^{††}, **E** media^{††}

A Select the fireplace:

30FIDNIS-01 TRADITIONAL

24,000 BTU NG / 23,000 BTU LP Model equipped with Proflame 2 IPI 3"x3" Co-linear Direct Vent. Ceramic burner and logset, Multi-function remote control, Halogen downlighting, Remote Hi-Lo flame control, Battery backup, micro mesh screen

MUST ORDER BELOW LOGSET TO COMPLETE INSTALLATION

Illume 30FID Insert Traditional	NG	30FIDNIS-01	\$3,599.00
NG to LP Conversion Kit	LP	GCA003	\$149.00
Illume 30FID Traditional Logset	LGS30FI		\$759.00

Shipping Weight: 118lb Length: 36" Width: 17" Height: 22"

30FIDNIL-01 CONTEMPORARY

24,000 BTU NG / 23,000 BTU LP Model equipped with Proflame 2 IPI 3"x3" Co-linear Direct Vent. Multi-function remote control, Black porcelain liner, Halogen uplighting, Remote Hi-Lo flame control, Battery backup, micro mesh screen

UNIT REQUIRES 9 LBS. OF GLASS MEDIA, ORDER SEPARATELY.

Illume 30FID Insert Contemporary	NG	30FIDNIL-01	\$4,249.00
NG to LP Conversion Kit	LP	GCA003	\$149.00

Shipping Weight: 110lb Length: 36" Width: 17" Height: 22"

B Select the required venting components:

30FID VENTING COMPONENTS

Duravent Termination [high wind]	46DVA-VCH	\$189.00
Duravent Colinear to Co-axil Adaptor	46DVA-GK	\$384.00
Duravent 3" Flex Linear Coupling	3DFA-FC	\$23.00
35' Length of 3" Aluminum Flex [bulk, compressed]	VT35FL3BC	\$249.00

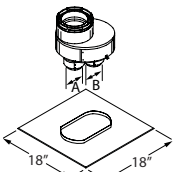

46DVA-GK



46DVA-VCH

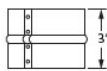

3DFA-FC

†† Contemporary units do not require a liner order, they come standard with porcelain panels.

C (Traditional) Select the firebox liner:

30FID FIREBOX LINERS

Illume 30FID Ceramic Brown Brick Liner [trad. only]	BRK30FIB	\$261.00
Illume 30FID Ceramic Red Brick Liner [trad. only]	BRK30FIR	\$261.00
Illume Inserts 30FID Porcelain Panels [black]	RPP30FID	\$619.00

D Select the required surround:

30FID SURROUND

Illume 30FID Square Surround [satin black, 42" wide x 27" high]	FP30FID-01	\$409.00
Illume 30FID Square Surround Offset Kit - must order FP30FID [satin black, 43½" wide x 27½" high x 4¼" deep]	FP30FIDOF	\$269.00
Illume 30FID Oversized Square Surround [satin black, 48" wide x 30" high]	FP30FIDOS-01	\$439.00
Illume 30FID 4-Sided Surround [satin black, 42" wide x 32" high]	FP30FID4S-01	\$439.00

FOUR SIDED SURROUND

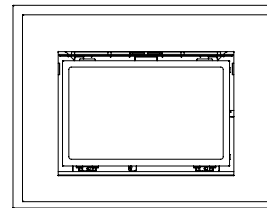

SQUARE SURROUND WITH OFFSET KIT

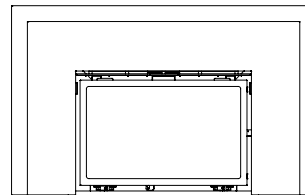
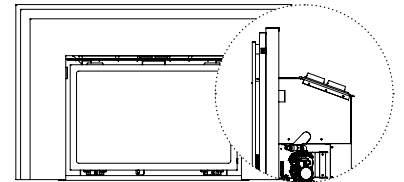

OVERSIZED SQUARE SURROUND

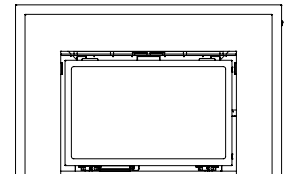

SQUARE SURROUND

E (Contemporary) Select the decorative media:

30FID CONTEMPORARY DECORATIVE MEDIA

Speckled Stones 150pc	RR150SS	\$244.00
Driftwood Kit Small	LGS59	\$284.00

Optional components

COMPONENTS

Illume Insert 2 Fan Kit	RFKFIDECO	\$359.00
Proflame 2 WiFi Dongle	SIT-WIFI	\$244.00



NOT COMPATIBLE NOT COMPATIBLE NOT COMPATIBLE NOT COMPATIBLE NOT COMPATIBLE NOT COMPATIBLE NOT COMPATIBLE



Illume 34FID

NOTES:
For optional glass media SKU and price (firestones, firebeads, fireglass) please refer to media page. The quantity of bags required can be found in the unit description.

MUST ORDER: **A** Fireplace, **B** venting, **C** surround, **D** liner**, **E** media**

A Select the fireplace:

34FIDNIS-01 TRADITIONAL

31,000 BTU NG / 30,000 BTU LP Model equipped with Proflame 2 IPI 3"x4" Co-linear Direct Vent. Ceramic burner and logset, Multi-function remote control, Halogen downlighting, Remote Hi-Lo flame control, Battery backup, micro mesh screen

MUST ORDER BELOW LOGSET TO COMPLETE INSTALLATION

Illume 34FID Insert Traditional	NG	34FIDNIS-01	\$4,029.00
NG to LP Conversion Kit	LP	GCA006	\$149.00
Illume 34FID Traditional Logset	LGS34FI		\$839.00

Shipping Weight: 126lb Length: 40" Width: 18" Height: 25"

34FIDNIL-01 CONTEMPORARY

31,000 BTU NG / 30,000 BTU LP Model equipped with Proflame 2 IPI 3"x4" Co-linear Direct Vent. Multi-function remote control, Black porcelain liner, Halogen uplighting, Remote Hi-Lo flame control, Battery backup, micro mesh screen

UNIT REQUIRES 9 LBS. OF GLASS MEDIA, ORDER SEPARATELY.

Illume 34FID Insert Contemporary	NG	34FIDNIL-01	\$4,769.00
NG to LP Conversion Kit	LP	GCA006	\$149.00

Shipping Weight: 118lb Length: 40" Width: 18" Height: 25"

B Select the required venting components:

34FID VENTING COMPONENTS

Duravent Termination [high wind]	46DVA-VCH	\$189.00
Duravent Co-linear to Co-axil Adaptor 3" X 4"	46DVA-CT	\$384.00
Duravent 3" Flex Linear Coupling	3DFA-FC	\$23.00
Duravent 4" Flex Linear Coupling [optional]	4DFA-FC	\$19.00
35' Length of 3" Aluminum Flex [bulk, compressed]	VT35FL3BC	\$249.00
35' Length of 4" Aluminum Flex [bulk, compressed]	VT35FL4BC	\$309.00

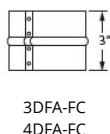
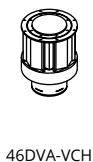
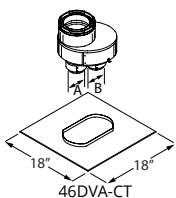

C (Traditional) Select the firebox liner:

34FID FIREBOX LINERS

Illume 34FID Ceramic Brown Brick Liner [trad. only]	BRK34FIB	\$287.00
Illume 34FID Ceramic Red Brick Liner [trad. only]	BRK34FIR	\$287.00
Illume Inserts 34FID Porcelain Panels [black]	RPP34FID	\$679.00

D Select the required surround:

34FID SURROUND

Illume 34FID Square Surround [satin black, 46½" wide x 31" high]	FP34FID-01	\$459.00
Illume 34FID Oversized Square Surround [satin black, 52" wide x 33½" high]	FP34FIDOS-01	\$489.00
Illume 34FID 4-Sided Surround [satin black, 46½" wide x 36" high]	FP34FID4S-01	\$489.00

FOUR SIDED SURROUND

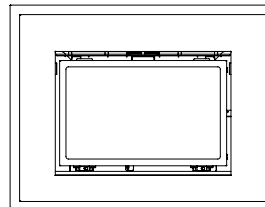

SQUARE SURROUND

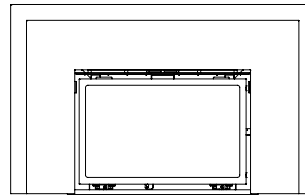
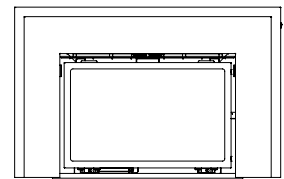

OVERSIZED SQUARE SURROUND

E (Contemporary) Select the decorative media:

34FID CONTEMPORARY DECORATIVE MEDIA

Speckled Stones 200pc	RR200SS	\$354.00
Driftwood Kit Small	LGS59	\$284.00

Optional components

COMPONENTS

Illume Insert 2 Fan Kit	RFKFIDECO	\$359.00
Proflame 2 WiFi Dongle	SIT-WIFI	\$244.00

PAGE IS INTENTIONALLY LEFT BLANK FOR PRINTING PURPOSES
(INSERT SECTION TAB HERE)

PAGE IS INTENTIONALLY LEFT BLANK FOR PRINTING PURPOSES
(INSERT SECTION TAB HERE)



Divine Ventless Outdoor

NOTES:
For optional glass media SKU and price (firestones, firebeads, fireglass) please refer to media page. The quantity of bags required can be found in the unit description.

MUST ORDER: Fireplace

A Select the fireplace:

H34VO** STANDING PILOT

26,000 BTU NG/LP Standard model with Hi/Lo Valve

Divine H34VO Outdoor NG	NG	H34VON	\$3,789.00
Divine H34VO Outdoor LP Divine H34VO Extérieur PL	LP	H34VOL	\$3,789.00

Shipping Weight: 149lb Length: 39½" Width: 21½" Height: 39½"

H34VO** HOT SURFACE IGNITION

26,000 BTU NG/LP Model equipped with Honeywell HSI No Hi/Lo adjustment available

Divine H34VO Outdoor NG HSI	NG	H34VONE	\$4,049.00
Divine H34VO Outdoor LP HSI	LP	H34VOLE	\$4,049.00

Shipping Weight: 149lb Length: 39½" Width: 21½" Height: 39½"

H38VO** STANDING PILOT

34,000 BTU NG/LP Standard model with Hi/Lo Valve

Divine H38 Outdoor Traditional NG	NG	H38VON	\$4,329.00
Divine H38 Outdoor Traditional LP	LP	H38VOL	\$4,329.00

Shipping Weight: 169lb Length: 42½" Width: 22" Height: 42½"

H38VO** HOT SURFACE IGNITION

34,000 BTU NG/LP Model equipped with Honeywell HSI No Hi/Lo adjustment available†

Divine H38 Outdoor Traditional NG	NG	H38VONE	\$4,589.00
Divine H38 Outdoor Traditional LP	LP	H38VOLE	\$4,589.00

Shipping Weight: 169lb Length: 42½" Width: 22" Height: 42½"

H42VO** STANDING PILOT

40,000 BTU NG/LP Standard model with Hi/Lo Valve

Divine Outdoor H42 Traditional NG	NG	H42VON	\$5,099.00
Divine Outdoor H42 Traditional LP	LP	H42VOL	\$5,099.00

Shipping Weight: 188lb Length: 46" Width: 25½" Height: 43"

H42VO** HOT SURFACE IGNITION

40,000 BTU NG/LP Model equipped with Honeywell HSI No Hi/Lo adjustment available†

Divine Outdoor H42 Traditional NG	NG	H42VONE	\$5,379.00
Divine Outdoor H42 Traditional LP	LP	H42VOLE	\$5,379.00

Shipping Weight: 188lb Length: 46" Width: 25½" Height: 43"

HL38VO** CONTEMPORARY STANDING PILOT

34,000 BTU NG/LP Standard model with Hi/Lo Valve. Unit supplied with 9 lbs. of Ice fireglass. [HW1157]

Divine HL38VO Contemporary Outdoor NG	NG	HL38VON	\$4,329.00
Divine HL38VO Contemporary Outdoor LP	LP	HL38VOL	\$4,329.00

Shipping Weight: 169lb Unit Length: 42½" Width: 22" Height: 42½"

HL38VO** CONTEMPORARY HOT SURFACE IGNITION

34,000 BTU NG/LP Model equipped with Honeywell HSI No Hi/Lo adjustment available.† Unit supplied with 9 lbs. of Ice fireglass. [HW1157]

Divine HL38VO Contemporary Outdoor NG	NG	HL38VONE	\$4,589.00
Divine HL38VO Contemporary Outdoor LP	LP	HL38VOLE	\$4,589.00

Shipping Weight: 169lb Unit Length: 42½" Width: 22" Height: 42½"

Optional decorative media:

34 MEDIA

Colonial Brick Lining [white, H34 only]	HBK34SHC	\$334.00
Heritage Brick Lining [brown, H34 only]	HBK34SHR	\$389.00
Herringbone Brick Lining [H34 only]	HBK34H	\$409.00
H34VO Mirror Back Panel	RPH34VOR	\$179.00
Wrought Iron Grate 34	HWIG34	\$61.00
H34VO Drain Pan	ODSSP34	\$239.00

38 MEDIA

Colonial Brick Lining [white, H38 only]	HBK38C	\$349.00
Heritage Brick Lining [brown, H38 only]	HBK38R	\$409.00
Herringbone Brick Lining [H38 only]	HBK38H	\$499.00
H38VO Mirror Back Panel	RPH38VOR	\$309.00
Wrought Iron Grate 38	HWIG38	\$88.00
H38VO Drain Pan	ODSSP38	\$259.00

42 MEDIA

Colonial Brick Lining [white, H42 only]	HBK42C	\$369.00
Heritage Brick Lining [brown, H42 only]	HBK42R	\$424.00
Herringbone Brick Lining [H42 only]	HBK42H	\$519.00
H42VO Mirror Back Panel	RPH42VOR	\$499.00
Wrought Iron Grate 42	HWIG42	\$89.00
H42VO Drain Pan	ODSSP42	\$299.00



NOT COMPATIBLE

NOT COMPATIBLE

NOT COMPATIBLE

NOT COMPATIBLE

NOT COMPATIBLE

NOT COMPATIBLE

NOT COMPATIBLE

Divine ST Ventless Outdoor

NOTES:

For optional glass media SKU and price (firestones, firebeads, fireglass) please refer to media page. The quantity of bags required can be found in the unit description.

MUST ORDER: Fireplace

A Select the fireplace:

H38SVO* STANDING PILOT			
45,000 BTU NG/LP Standard model with Hi/Lo Valve			
Divine H38SVO See Through Outdoor NG	NG	H38SVON	\$8,469.00
Divine H38SVO See Through Outdoor LP	LP	H38SVOL	\$8,469.00
Shipping Weight: 209lb Length: 46" Width: 27½" Height: 42½"			

HL38SVO* STANDING PILOT			
45,000 BTU NG/LP Standard model with Hi/Lo Valve Unit supplied with 12 lbs. of Ice fireglass. [HW1157]			
Divine HL38SVO See Through Contemporary Outdoor NG	NG	HL38SVON	\$8,469.00
Divine HL38SVO See Through Contemporary Outdoor LP	LP	HL38SVOL	\$8,469.00
Shipping Weight: 209lb Length: 46" Width: 27½" Height: 42½"			

H38SVO* HOT SURFACE IGNITION			
45,000 BTU NG/LP Model with Honeywell HSI No Hi/Lo adjustment			
Divine H38SVO See Through Outdoor NG	NG	H38SVONE	\$8,739.00
Divine H38SVO See Through Outdoor LP	LP	H38SVOLE	\$8,739.00
Shipping Weight: 209lb Length: 46" Width: 27½" Height: 42½"			

HL38SVO* HOT SURFACE IGNITION			
45,000 BTU NG/LP Model with Honeywell HSI No Hi/Lo adjustment Unit supplied with 12 lbs. of Ice fireglass. [HW1157]			
Divine HL38SVO See Through Contemporary Outdoor NG	NG	HL38SVONE	\$8,739.00
Divine HL38SVO See Through Contemporary Outdoor LP	LP	HL38SVOLE	\$8,739.00
Shipping Weight: 209lb Length: 46" Width: 27½" Height: 42½"			

Optional components:

ENCLOSURE		
Divine Outdoor See Through Enclosure	H38SVOBE	\$2,479.00

† HSI equipped; use ground fault protected outlet in fireplace.

Mahana

NOTES:

For optional glass media SKU and price (firestones, firebeads, fireglass) please refer to media page. The quantity of bags required can be found in the unit description.

MUST ORDER: Fireplace

A Select the fireplace:

PL42VO*E

28,000 BTU NG/LP Model equipped with Honeywell HSI No Hi/Lo adjustment available
Unit supplied with 6 lbs. of Quartz firestones. [HW1106]

Mahana PL42VO NG	NG	PL42VONE	\$6,789.00
Mahana PL42VO LP	LP	PL42VOLE	\$6,789.00

Shipping Weight: 140lb Length: 46" Width: 14½" Height: 32½"

PL60VO*E

47,000 BTU NG/LP Model equipped with Honeywell HSI No Hi/Lo adjustment available
Unit supplied with 9 lbs. of Quartz firestones. [HW1106]

Mahana PL60VO NG	NG	PL60VONE	\$11,499.00
Mahana PL60VO LP	LP	PL60VOLE	\$11,499.00

Shipping Weight: 288lb Length: 69" Width: 18" Height: 38"

Optional decorative media:

PL42VO MEDIA

Speckled Stones 150pc	RR150SS	\$244.00
Driftwood Kit Small	LGS59	\$284.00

PL60VO MEDIA

Speckled Stones 300pc	RR300SS	\$519.00
Driftwood Kit Small	LGS59	\$284.00

ORDER 2

AVAILABLE MAHANA ENCLOSURE COLORS:

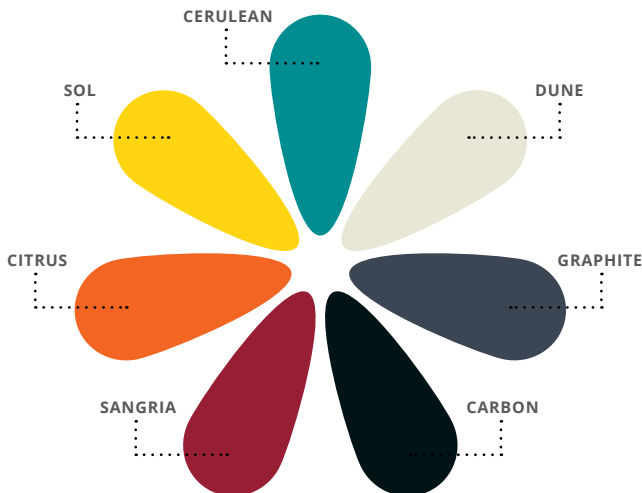

Optional components:

MAHANA ACCESSORIES

Remote Control Kit [on/off, includes weatherproof box]	RXM40VACVO	\$514.00
--	------------	----------

MAHANA 42 ACCESSORIES

Mahana PL42VO LED Kit	MCLED42VO	\$609.00
Mahana PL42VO Enclosure Cover	PL42CVR	\$159.00
Mahana PL42VO Stainless Enclosure	PL42VOBE	\$2,419.00
Mahana PL42VO Enclosure Pedestal Base [stainless only]	PL42VOBE-P	\$344.00
Mahana PL42VO Enclosure [Carbon]	PL42VOCAR	\$2,559.00
Mahana PL42VO Enclosure [Graphite]	PL42VOGRA	\$2,559.00
Mahana PL42VO Enclosure [Dune]	PL42VODUN	\$2,559.00
Mahana PL42VO Enclosure [Sangria]	PL42VOSAN	\$2,559.00
Mahana PL42VO Enclosure [Citrus]	PL42VOCIT	\$2,559.00
Mahana PL42VO Enclosure [Sol]	PL42VOSOL	\$2,505.00
Mahana PL42VO Enclosure [Cerulean]	PL42VOCER	\$2,559.00

MAHANA 60 ACCESSORIES

Mahana PL60VO LED Kit	MCLED60VO	\$739.00
Mahana PL60VO Enclosure Cover	PL60CVR	\$194.00
Mahana PL60VO Stainless Enclosure	PL60VOBE	\$2,809.00
Mahana PL60VO Enclosure Pedestal Base [stainless only]	PL60VOBE-P	\$559.00
Mahana PL60VO Enclosure [Carbon]	PL60VOCAR	\$2,949.00
Mahana PL60VO Enclosure [Graphite]	PL60VOGRA	\$2,949.00
Mahana PL60VO Enclosure [Dune]	PL60VODUN	\$2,887.00
Mahana PL60VO Enclosure [Sangria]	PL60VOSAN	\$2,887.00
Mahana PL60VO Enclosure [Citrus]	PL60VOCIT	\$2,887.00
Mahana PL60VO Enclosure [Sol]	PL60VOSOL	\$2,887.00
Mahana PL60VO Enclosure [Cerulean]	PL60VOCER	\$2,949.00



PAGE IS INTENTIONALLY LEFT BLANK FOR PRINTING PURPOSES
(INSERT SECTION TAB HERE)

PAGE IS INTENTIONALLY LEFT BLANK FOR PRINTING PURPOSES
(INSERT SECTION TAB HERE)



Wildfire Wood Fireboxes 36"-44"

MUST ORDER: **A** Fireplace, **B** Brick liner

A Select the fireplace:

36" WOOD BURNING FIREBOX, NO BRICK

- | | |
|-----------------------------------|-----------------|
| Includes: | Requires: |
| • Heavy Duty 3/4" bar stock grate | • Brick Liner |
| • Easy access air control | • Venting - 12" |
| • Pull Screen | |

36" Wood Burning Firebox, No Brick	WB36FB0F	\$2,849.00
------------------------------------	----------	------------

Opening - 36" x 30" Up to 18" Log

44" WOOD BURNING FIREBOX, NO BRICK

- | | |
|-----------------------------------|-----------------|
| Includes: | Requires: |
| • Heavy Duty 3/4" bar stock grate | • Brick Liner |
| • Easy access air control | • Venting - 12" |
| • Pull Screen | |

44" Wood Burning Firebox, No Brick	WB44FB0F	\$2,999.00
------------------------------------	----------	------------

Opening - 44" x 30" Up to 24" Log

B Select the required brick liner:

36" BRICK LINERS

36" Traditional Brick Set Gray	WBL36TGR	\$899.00
36" Traditional Brick Set Black	WBL36TBL	\$959.00
36" Traditional Brick Set White	WBL36TWH	\$959.00
36" Traditional Brick Set Mocha	WBL36TBR	\$959.00
36" Herringbone Brick Set Gray	WBL36HGR	\$899.00
36" Herringbone Brick Set Black	WBL36HBL	\$959.00
36" Herringbone Brick Set White	WBL36HWH	\$959.00
36" Herringbone Brick Set Mocha	WBL36HBR	\$959.00
36" Smooth Brick Set Gray	WBL36SGR	\$899.00
36" Smooth Brick Set Black	WBL36SBL	\$959.00
36" Smooth Brick Set White	WBL36SWH	\$959.00
36" Smooth Brick Set Mocha	WBL36SBR	\$959.00

44" BRICK LINERS

44" Traditional Brick Set Gray	WBL44TGR	\$999.00
44" Traditional Brick Set Black	WBL44TBL	\$1,049.00
44" Traditional Brick Set White	WBL44TWH	\$1,049.00
44" Traditional Brick Set Mocha	WBL44TBR	\$1,049.00
44" Herringbone Brick Set Gray	WBL44HGR	\$999.00
44" Herringbone Brick Set Black	WBL44HBL	\$1,049.00
44" Herringbone Brick Set White	WBL44HWH	\$1,049.00
44" Herringbone Brick Set Mocha	WBL44HBR	\$1,049.00
44" Smooth Brick Set Gray	WBL44SGR	\$999.00
44" Smooth Brick Set Black	WBL44SBL	\$1,049.00
44" Smooth Brick Set White	WBL44SWH	\$1,049.00
44" Smooth Brick Set Mocha	WBL44SBR	\$1,049.00

Optional accessories:

36" DOORS

36" Black Bi-Fold Door w/Wood handles	BDW36BL	\$569.00
36" Pewter Bi-Fold Door w/Wood handles	BDW36PE	\$569.00

44" DOORS

44" Black Bi-Fold Door w/Wood handles	BDW44BL	\$599.00
44" Pewter Bi-Fold Door w/Wood handles	BDW44PE	\$599.00

OUTSIDE AIR

Outside Air Kit	WBOAK	\$89.00
Insulated Duct Outside Air Kit	WBID	\$79.00
Non-Insulated Duct For Outside Air Kit	WBNID	\$59.00
12" Chimney Air Kit - Must Order Outside Air kit and Flex	WB12VCAK	\$69.00

36" HEARTH EXTENSION

Hearth Extension (52"x "x 20") 3 piece	WB36HE	\$99.00
--	--------	---------

44" HEARTH EXTENSION

44" Hearth Extension (68 "x 20"x 1/2") 3 piece	WB44HE	\$109.00
--	--------	----------



NOT COMPATIBLE

NOT COMPATIBLE

NOT COMPATIBLE

WOOD FIREBOX

NOT COMPATIBLE

NOT COMPATIBLE

NOT COMPATIBLE

NOT COMPATIBLE



Wildfire Wood Fireboxes 54"

MUST ORDER: **A** Fireplace, **B** Brick liner

A Select the fireplace:

54" WOOD BURNING FIREBOX, NO BRICK

Includes:

- Heavy Duty 3/4" bar stock grate
- Easy access air control
- Pull Screen

Requires:

- Brick Liner
- Venting - 14"

54" Wood Burning Firebox, No Brick	WB54FB0F	\$3,199.00
------------------------------------	----------	------------

Opening - 54" x 34" Up to 30" Log

Optional accessories:

54" DOORS

54" Black Bi-Fold Door w/Wood handles	BDW54BL	\$699.00
54" Pewter Bi-Fold Door w/Wood handles	BDW54PE	\$699.00

OUTSIDE AIR

Outside Air Kit	WBOAK	\$89.00
Insulated Duct Outside Air Kit	WBID	\$79.00
Non-Insulated Duct For Outside Air Kit	WBNID	\$59.00
14" Chimney Air Kit - Must Order Outside Air kit and Flex	WB14VCAK	\$69.00

HEARTH EXTENSION

54" Hearth Extension (78 "x 20"x 1") 6 piece	WB54HE	\$119.00
--	--------	----------

B Select the required brick liner:

54" BRICK LINERS

54" Traditional Brick Set Gray	WBL54TGR	\$1,099.00
54" Traditional Brick Set Gray	WBL54TBL	\$1,149.00
54" Traditional Brick Set White	WBL54TWH	\$1,149.00
54" Traditional Brick Set Mocha	WBL54TBR	\$1,149.00
54" Herringbone Brick Set Gray	WBL54HGR	\$1,099.00
54" Herringbone Brick Set Black	WBL54HBL	\$1,149.00
54" Herringbone Brick Set White	WBL54HWH	\$1,149.00
54" Herringbone Brick Set Mocha	WBL54HBR	\$1,149.00
54" Smooth Brick Set Gray	WBL54SGR	\$1,099.00
54" Smooth Brick Set Black	WBL54SBL	\$1,149.00
54" Smooth Brick Set White	WBL54SWH	\$1,149.00
54" Smooth Brick Set Mocha	WBL54SBR	\$1,149.00

PAGE IS INTENTIONALLY LEFT BLANK FOR PRINTING PURPOSES
(INSERT SECTION TAB HERE)

PAGE IS INTENTIONALLY LEFT BLANK FOR PRINTING PURPOSES
(INSERT SECTION TAB HERE)

4"/7" Direct Vent Components

VENT PIPES - STRAIGHT RIGID

18" Rigid Section [female/female]	EXT18	\$59.00
12" Rigid Section [female/male]	MEXT1	\$144.00
24" Rigid Section [female/male]	MEXT2	\$169.00
36" Rigid Section [female/male]	MEXT3	\$189.00
48" Rigid Section [female/male]	MEXT4	\$209.00
72" Rigid Section [female/male]	MEXT6	\$234.00

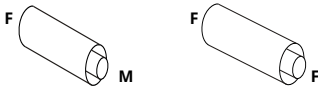

MEXT1, MEXT2, MEXT3, MEXT4, MEXT6

EXT18

VENT PIPES - FLEX SECTIONS*

4"/7" Flex vent F/F, 24" Expanded	MFL2-F	\$174.00
4"/7" Flex vent F/F, 48" Expanded	MFL4-F	\$203.00
4"/7" Flex vent F/F, 72" Expanded	MFL6-F	\$203.00

VERTICAL INSTALLATION ADAPTER

10" Flue Adapter for Straight Vertical Installations [female/female]	MXT10	\$37.00
--	-------	---------

VENT CONNECTOR

4" Vent Connector [male/male]	MVA	\$25.00
-------------------------------	-----	---------



MXT10

MVA

VERTICAL TERMINATION

Stainless Termination for Vertical Installations [includes MXT10 adapter, for straight, vertical installations]	MVTK1SS	\$299.00
---	---------	----------



MVTK1SS

VENT PIPES - ELBOWS

45° Solid Elbow Section [female/male connectors]	EEL45	\$96.00
90° Elbow [female/female]	MEL90F/F	\$179.00
90° Elbow [female/male]	MEL90F/M	\$179.00
90° Elbow [female/male]	MEL90M/M	\$179.00



EEL45

MEL90F/M

MEL90M/M

MEL90F/F

HORIZONTAL TERMINATIONS

4"/7" Termination without Mounting Frame [use with MSR or MOSR]	MTO4	\$224.00
4"/7" Termination w/Integral Mounting Frame	MTO4F	\$259.00
4"/7" Termination w/Continuous Formed Perimeter Nailing Flange	MTO4F-2	\$319.00
4"/7" Stainless Termination without Mounting Frame [use with MSRSS or MOSRSS]	MTO4SS	\$479.00
4"/7" Stainless Termination w/Integral Mounting Frame	MTO4FSS	\$489.00
4"/7" Stainless Termination w/Continuous Formed Perimeter Nailing Flange	MTO4F-2SS	\$519.00

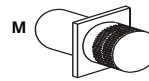

MTO4

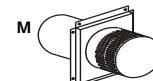

MTO4F

TERMINATION FRAMES

Siding or Stucco Frame [for easy installation of termination]	MSR	\$64.00
Siding or Stucco Can [for installing termination from the inside of building]	MOSR	\$119.00
Stainless Siding or Stucco Frame [for easy installation of termination]	MSRSS	\$91.00
Stainless Siding or Stucco Frame [for easy installation of termination]	MOSRSS	\$294.00
Brick Siding Can 4"	BSR4	\$63.00
Brick Siding Can 6"	BSR6	\$63.00



MSR

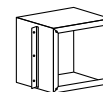

MOSR

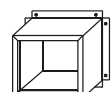

BSR4, BSR6



4"/7" Direct Vent Components Cont.

SNORKEL TERMINATION

4"/7" Snorkel 18" Vertical Rise	SNK47-2	\$1,219.00
4"/7" Snorkel 30" Vertical Rise	SNK47-3	\$1,319.00

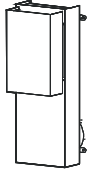

SNK47-2, SNK47-3

HEAT GUARD

Heat Guard [fits all 4"/7" and 5"/8" terminations]	MTKOG	\$189.00
--	-------	----------

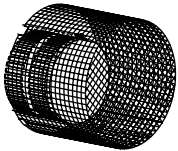

MTKOG

HEAT SHIELDS

Through-the-Wall Radiation Shield for 4"/7" Venting	RHS100	\$109.00
Vinyl Siding Shield	VSS	\$36.00
Vinyl Siding Stainless Shield	VSSSS	\$69.00

VERTICAL INSTALLATION ACCESSORIES

7" Fire Stop	FS7	\$21.00
7" Support Plate & Support Ring	MSPXT7	\$100.00
7" Support Plate & Support Ring [bulk pack of 6]	MSP706	\$369.00
Flashing & Storm Collar for 1/12 to 7/12 Pitch Roof	MRF7	\$70.00
Flashing & Storm Collar for 7/12 to 12/12 Pitch Roof	MRF12	\$109.00
Flat Roof Flashing & Storm Collar 7"	FRF7	\$129.00



FS-7



MSPXT-7

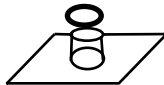

MRF-7, MRF-12

HORIZONTAL VENT RESTRICTORS

Horizontal Vent Restrictor for 8' - 14' Horizontal Vent Run	MHVR8	\$18.00
Horizontal Vent Restrictor for 15' - 24' Horizontal Vent Run	MHVR15	\$18.00
Horizontal Vent Restrictor for 25' - 35' Horizontal Vent Run	MHVR25	\$18.00

VERTICAL VENT RESTRICTORS

Vertical Vent Restrictor for 8' - 14' Vertical Vent Run	MVVR8	\$18.00
Vertical Vent Restrictor for 15' - 24' Vertical Vent Run	MVVR15	\$19.00
Vertical Vent Restrictor for 25' or Greater Vertical Vent Run	MVVR25	\$18.00

THRU-THE-WALL VENTING KITS

Wall Penetration Rigid Kit 18 inch kit includes RHS100 wall heat shield, MXT18 -18" F/F rigid pipe (can be cut up to 9" length) and MTO4 termination with frame. Suitable for corner installations and straight through the wall installations.	MRVK01	\$399.00
Wall Penetration Rigid Kit 18 inch kit includes RHS100 wall heat shield, MXT18 -18" F/F rigid pipe (can be cut up to 9" length) and MTO4F termination with frame. Suitable for straight through the wall installations.	MRVK01F	\$339.00

5"/8" Direct Vent Components

VENT PIPES - STRAIGHT RIGID

5" Rigid Section [female/female]	PXT5	\$27.00
10" Rigid Section [female/female]	PXT10	\$39.00
12" Rigid Section [female/female]	PXT12	\$41.00
20" Rigid Section [female/female]	PXT20	\$95.00
12" Rigid Section [female/male]	PEXT1	\$154.00
24" Rigid Section [female/male]	PEXT2	\$184.00
36" Rigid Section [female/male]	PEXT3	\$194.00
48" Rigid Section [female/male]	PEXT4	\$204.00
72" Rigid Section [female/male]	PEXT6	\$224.00

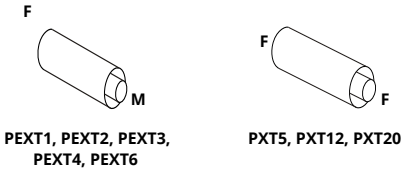

VENT PIPES - FLEX SECTIONS

5"/8" Flex vent F/F, 24" Expanded	PFL2-F	\$203.00
5"/8" Flex vent F/F, 48" Expanded	PFL4-F	\$203.00
5"/8" Flex vent F/F, 72" Expanded	PFL6-F	\$203.00

VENT PIPES - ELBOWS

45° Elbow [female/male]	PEL45F/M	\$119.00
90° Elbow [female/female]	PEL90F/F	\$199.00
90° Elbow [male/male]	PEL90M/M	\$199.00
90° Elbow [female/male]	PEL90F/M	\$194.00

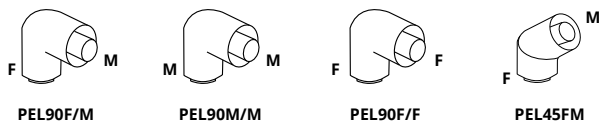

VERTICAL VENT REDUCER

5"/8" to 4"/7" Reducer 10" Length [male/female]	PVA5487	\$129.00
---	---------	----------

VENT CONNECTOR

5" Vent Connector [male/male]	PVA	\$52.00
-------------------------------	-----	---------



HORIZONTAL TERMINATIONS

5"/8" Termination without Mounting Frame [use with MSR or MOSR]	PTO4	\$259.00
5"/8" Termination w/Integral Mounting Frame	PTO4F	\$294.00
5"/8" Termination w/Continuous Formed Perimeter Nailing Flange	PTO4F-2	\$329.00
5"/8" Stainless Termination without Mounting Frame [use with MSRSS or MOSRSS]	PTO4SS	\$444.00
5"/8" Stainless Termination w/Integral Mounting Frame	PTO4FSS	\$479.00
5"/8" Stainless Termination w/Continuous Formed Perimeter Nailing Flange	PTO4F-2SS	\$549.00

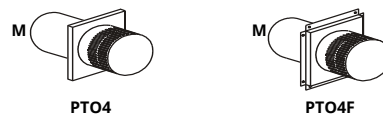

TERMINATION FRAMES

Siding or Stucco Frame [for easy installation of termination]	MSR	\$64.00
Siding or Stucco Can [for installing termination from the inside of building]	MOSR	\$119.00
Stainless Siding or Stucco Frame [for easy installation of termination]	MSRSS	\$91.00
Stainless Siding or Stucco Frame [for easy installation of termination]	MOSRSS	\$294.00
Brick Siding Can 4"	BSR4	\$63.00
Brick Siding Can 6"	BSR6	\$63.00



5"/8" Direct Vent Components Cont.

SNORKEL TERMINATION

5"/8" Snorkel 18" Vertical Rise	SNK58-2	\$1,319.00
5"/8" Snorkel 30" Vertical Rise	SNK58-3	\$1,519.00

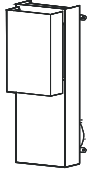

SNK58-2, SNK58-3

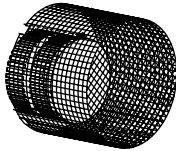

MTKOG

HEAT GUARD

Heat Guard [fits all 4"/7" and 5"/8" terminations]	MTKOG	\$189.00
--	-------	----------

HEAT SHIELDS

Through-the-Wall Radiation Shield for 5"/8" Venting	RHS101	\$114.00
Vinyl Siding Shield	VSS	\$36.00
Vinyl Siding Stainless Shield	VSSSS	\$69.00

VERTICAL INSTALLATION ACCESSORIES

8" Fire Stop	FS8	\$22.00
8" Support Plate & Support Ring	PSPXT8	\$67.00
8" Support Plate & Support Ring [bulk pack of 6]	PSP806	\$359.00
Flashing & Storm Collar for 1/12 to 7/12 Pitch Roof	PRF7	\$75.00
Flashing & Storm Collar for 7/12 to 12/12 Pitch Roof	PRF12	\$159.00
Flat Roof Flashing & Storm Collar 8"	FRF8	\$139.00



PSPXT-8

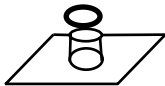

PRF-7, PRF-12



FS-8

VERTICAL TERMINATION

Stainless Termination for Vertical Installations	PVTK1SS	\$309.00
--	---------	----------



PVTK1SS

HORIZONTAL VENT RESTRICTORS

Horizontal Vent Restrictor for 8' - 14'	PHVR8	\$22.00
Horizontal Vent Restrictor for 15' - 24'	PHVR15	\$18.00
Horizontal Vent Restrictor for 25' - 35'	PHVR25	\$22.00

VERTICAL VENT RESTRICTORS

Vertical Vent Restrictor for 8' - 14'	PVVR8	\$19.00
Vertical Vent Restrictor for 15' - 24'	PVVR15	\$22.00
Vertical Vent Restrictor for 25' or greater	PVVR25	\$22.00

THRU-THE-WALL VENTING KITS

Wall Penetration Rigid Kit 18". Kit includes RHS101 wall heat shield, PXT18 - 18" F/F rigid pipe (can be cut up to 9" length) and PTO4 termination without frame. Suitable for corner installations and straight through-the-wall installations.	PRVK01	\$414.00
---	--------	----------

Wall Penetration Rigid Kit 18" with Frame. Kit includes RHS101 wall heat shield, PXT18 - 18" F/F rigid pipe (can be cut up to 9" length) and PTO4F termination with frame. Suitable for straight through-the-wall installations.	PRVK01F	\$429.00
---	---------	----------

5"/10" Direct Vent Components

VENT PIPES - STRAIGHT RIGID

10" Rigid Section [female/female]	RXT10	\$41.00
20" Rigid Section [female/female]	RXT20	\$77.00
12" Rigid Section [female/male]	REXT1	\$144.00
24" Rigid Section [female/male]	REXT2	\$169.00
36" Rigid Section [female/male]	REXT3	\$199.00
48" Rigid Section [female/male]	REXT4	\$229.00
72" Rigid Section [female/male]	REXT6	\$284.00

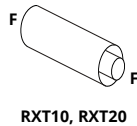
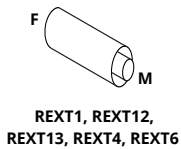

VENT PIPES - FLEX SECTIONS

5"/10" Flex vent F/F, 24" Expanded	RFL2-F	\$269.00
5"/10" Flex vent F/F, 48" Expanded	RFL4-F	\$369.00
5"/10" Flex vent F/F, 72" Expanded	RFL6-F	\$559.00

VENT PIPES - ELBOWS

45° Elbow [female/male]	REL45F/M	\$179.00
90° Elbow [female/female]	REL90F/F	\$289.00
90° Elbow [male/male]	REL90M/M	\$289.00
90° Elbow [female/male]	REL90F/M	\$289.00

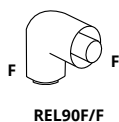
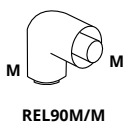
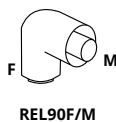

VERTICAL VENT REDUCER

10"- 8" Adapter Collar [for P52DF only]	RVA108	\$63.00
5"/10" to 4"/7" Reducer Collar [P52DF only]	LVA54107	\$224.00
5"/10" to 5"/8" Reducer [male/female]	RVA51058	\$224.00

WALL PENETRATION KIT

Kit includes RHS104 wall heat shield, RFL2 flexible pipe, and RTO4F termination with frame. Suitable for all TOP corner installations and up-and-out installations. [For P52DF only]	RFVK01F	\$659.00
--	---------	----------

HEAT SHIELDS

Through-the-Wall Radiation Shield for 5"/10" Venting	RHS102	\$134.00
Through-the-Wall Radiation Shield for 5"/10" Venting	RHS104	\$154.00

HORIZONTAL TERMINATION

Termination w/Integral Mounting Frame	RTO4F	\$336.00
---------------------------------------	-------	----------

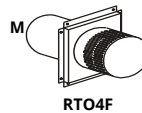

INSTALLATION ACCESSORIES

10" Fire Stop	FS10	\$30.00
---------------	------	---------

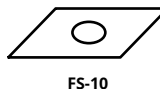



12" Wood Vent Components

VENT PIPES - STRAIGHT RIGID

6" Length 12" Diameter	WB12V06	\$119.00
12" Length 12" Diameter	WB12V12	\$139.00
18" Length 12" Diameter	WB12V18	\$169.00
36" Length 12" Diameter	WB12V36	\$249.00
48" Length 12" Diameter	WB12V48	\$305.00

VENT PIPES - ELBOWS

15 Degree Elbow Kit Includes 2 - 12" Diameter	WB12V15E	\$385.00
30 Degree Elbow Kit Includes 2 - 12" Diameter	WB12V30E	\$359.00

BANDS / SUPPORT BANDS

Support Band 12" Diameter	WB12VSB	\$29.00
Wall Band 12" Diameter	WB12VWB	\$45.00

HEAT SHIELDS

Firestop Assembly 12" Diameter	WB12VFS	\$59.00
Attic Insulation Shield 12" Diameter	WB12VAI	\$80.00
Radiation Shield 12" Diameter	WB12VRS	\$95.00

CHIMNEY CAP

Round Chimney Cap 12" Diameter	WB12VRCC	\$375.00
Black Painted Pyramid Chimney Cap 12"	WB12VPC	\$719.00
Rain Cap 12" Diameter	WB12VRC	\$185.00

STORM COLLARS / FLASHING

Storm Collar 12" Diameter	WB12VSC	\$49.00
Flashing 2/12-5/12 Pitch 12" Diameter	WB12VF05	\$415.00
Flashing 6/12-10/12 Pitch 12" Diameter	WB12VF10	\$419.00
Chase Top Flashing 12" Diameter	WB12VFC	\$249.00
Tall Cone Flashing 12" Diameter	WB12VFTC	\$419.00



14" Wood Vent Components

VENT PIPES - STRAIGHT RIGID

6" Length 14" Diameter	WB14V06	\$129.00
12" Length 14" Diameter	WB14V12	\$159.00
18" Length 14" Diameter	WB14V18	\$199.00
36" Length 14" Diameter	WB14V36	\$305.00
48" Length 14" Diameter	WB14V48	\$379.00

VENT PIPES - ELBOWS

15 Degree Elbow Kit Includes 2 - 14" Diameter	WB14V15E	\$419.00
30 Degree Elbow Kit Includes 2 - 14" Diameter	WB14V30E	\$389.00

BANDS / SUPPORT BANDS

Support Band 14" Diameter	WB14VSB	\$29.00
Wall Band 14" Diameter	WB14VWB	\$55.00

HEAT SHIELDS

Firestop Assembly 14" Diameter	WB14VFS	\$65.00
Attic Insulation Shield 14" Diameter	WB14VAI	\$80.00
Radiation Shield 14" Diameter	WB14VRS	\$95.00

CHIMNEY CAP

Round Chimney Cap 14" Diameter	WB14VRCC	\$389.00
Black Painted Pyramid Chimney Cap 14"	WB14VPC	\$749.00
Rain Cap 14" Diameter	WB14VRC	\$249.00

STORM COLLARS / FLASHING

Flashing 2/12-5/12 Pitch 14" Diameter	WB14VF05	\$419.00
Flashing 6/12-10/12 Pitch 14" Diameter	WB14VF10	\$459.00
Storm Collar 14" Diameter	WB14VSC	\$55.00
Chase Top Flashing 14" Diameter	WB14VFC	\$279.00
Tall Cone Flashing 14" Diameter	WB14VFTC	\$595.00

Flexmaster Vent Kits

VENT KIT NOTE

Venting kits are prepackaged sets of flex venting, wall shields, and terminations. The flex is collarless and must be milpacked and screwed. These kits are approved for all 4/7 and 5/8 fireplaces though cannot be used when the unit is powervented.



4/7 Horizontal vent kits

5' WALL PENETRATION KIT

Part	Code	List price
Wall Penetration Flex Kit Includes RHS100 wall heat shield, 5' flex pipe (with spacers), and MTO4 termination	MVK05	\$339.00
Wall Penetration Flex Kit (with term. frame) Includes RHS100 wall heat shield, 5' flex pipe (with spacers), and MTO4F	MVK05F	\$339.00

10' WALL PENETRATION KIT

Part	Code	List price
Wall Penetration Flex Kit Includes RHS100 wall heat shield, 10' flex pipe (with spacers), and MTO4 termination	MVK10	\$449.00
Wall Penetration Flex Kit (with term. frame) Includes RHS100 wall heat shield, 10' flex pipe (with spacers), and MTO4F	MVK10F	\$449.00

5/8 Horizontal vent kits

5' WALL PENETRATION KIT

Part	Code	List price
Wall Penetration Flex Kit Includes RHS101 wall heat shield, 5' flex pipe (with spacers), and PTO4 termination	PVK05	\$369.00
Wall Penetration Flex Kit (with term. frame) Includes RHS101 wall heat shield, 5' flex pipe (with spacers), and PTO4F	PVK05F	\$369.00

10' WALL PENETRATION KIT

Part	Code	List price
Wall Penetration Flex Kit Includes RHS101 wall heat shield, 10' flex pipe (with spacers), and PTO4 termination	PVK10	\$479.00
Wall Penetration Flex Kit (with term. frame) Includes RHS101 wall heat shield, 10' flex pipe (with spacers), and PTO4F	PVK10F	\$479.00

4/7 Vertical vent kits

20' ROOF PENETRATION KIT

Part	Code	List price
Roof Penetration Flex Kit Includes RHS100 wall heat shield, 20' flex pipe (with spacers), MEXT3 36" F/M rigid pipe, and MVTK1SS Roof Termination	MVK20V	\$1,179.00

4/7 Vent extension kits

20' EXTENSION KIT

Part	Code	List price
Extension Kit 20' flex pipe (with spacers), MVA connector	MVK20VE	\$699.00

5/8 Vertical vent kits

20' ROOF PENETRATION KIT

Part	Code	List price
Roof Penetration Flex Kit Includes RHS101 wall heat shield, 20' flex pipe (with spacers), PEXT3 36" F/M rigid pipe, and PVTK1SS Roof Termination	PVK20V	\$1,229.00

5/8 Vent extension kits

20' EXTENSION KIT

Part	Code	List price
Extension Kit 20' flex pipe (with spacers), PVA connector	PVK20VE	\$779.00



Vent Adapters

5/8 TO 4/6^{3/8} VENTING ADAPTERS

DV Vent Pipe Reducer, 5 x 8 to 4 x 6 5/8 [attach to top of fireplace only]	SD58DVAX46	\$129.00
--	------------	----------

4/7 ALTERNATE VENTING ADAPTERS

Montigo to DuraVent 4/7 Adapter	46DVA-AD-M1	\$77.00
Montigo to DuraVent 4/7 Termination Adapter	46DVA-AD-M2	\$77.00

5/8 ALTERNATE VENTING ADAPTERS

Montigo to DuraVent 5/8 Adapter	58DVA-AD-M1	\$79.00
Montigo to DuraVent 5/8 Termination Adapter	58DVA-AD-M2	\$79.00
Montigo to ICC ExcelDirect 5/8 Adapter	TM-5AA6	\$199.00
Montigo to ICC ExcelDirect 5/8 Termination Adapter	TM-5TA1	\$199.00
Montigo to MetalFab Sureseal 5/8 Adapter	5DNA	\$48.00
Montigo to MetalFab Sureseal 5/8 Termination Adapter	5DMTA	\$48.00

5/8 VENT REDUCER

5"/8" to 4"/7" Reducer 10" Length [male/female]	PVA5487	\$129.00
---	---------	----------

5/10 VENT REDUCER

10"- 8" Adapter Collar [for P52DF only]	RVA108	\$63.00
5"/10" to 4"/7" Reducer Collar [P52DF only]	LVA54107	\$224.00
5"/10" to 5"/8" Reducer [male/female]	RVA51058	\$224.00

DIRECT VENT ADAPTER TO 5" B-VENT

Direct Vent Adapter to 5" B-vent INCLUDES:		
<ul style="list-style-type: none"> DuraVent 5" B-Vent to DV conversion Lower and Upper adapter kit BVA35 DuraVent - Montigo collar adapter 46DVA-AD-M1 4/7 Male vent connector MVA Conversion label 	BVK35	\$274.00

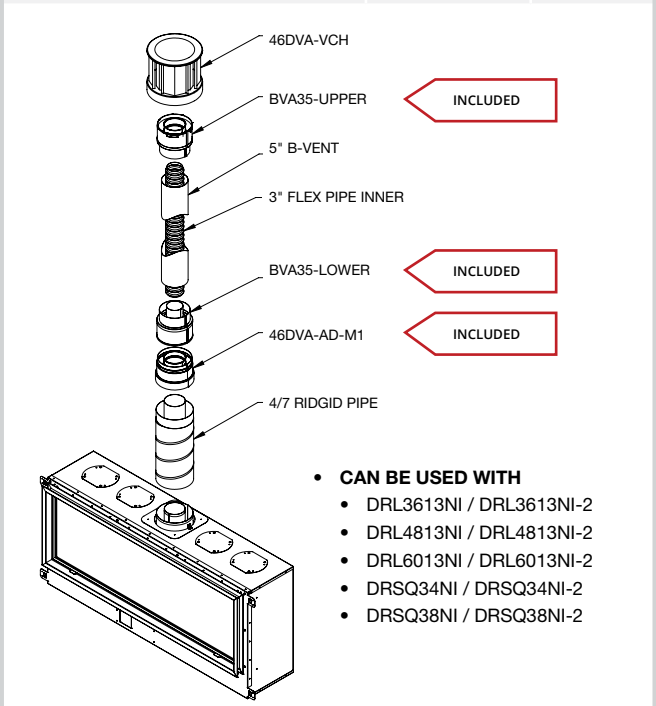

DURAVENT 3/5 ADAPTORS (FOR POWERVENTING ONLY)

DuraVent CVS to 46DVA	35CVS-X46DVA	\$254.00
DuraVent CVS to 58DVA	35CVS-X58DVA	\$274.00
DuraVent 46DVA to CVS	46DVA-X35CVS	\$248.00
DuraVent 58DVA to CVS	58DVA-X35CVS	\$274.00

Cool Wall Advantage

MUST ORDER: Cool wall system Flex pipe

A Select the Cool Wall system:

TV KITS

Cool Wall Advantage TV Kit 36"	HDKPD36	\$569.00
Cool Wall Advantage TV Kit 48"	HDKPD48	\$744.00
Cool Wall Advantage TV Kit 63"	HDKPD63	\$1,039.00
Cool Wall Advantage TV Kit 72"	HDKPD72	\$1,169.00

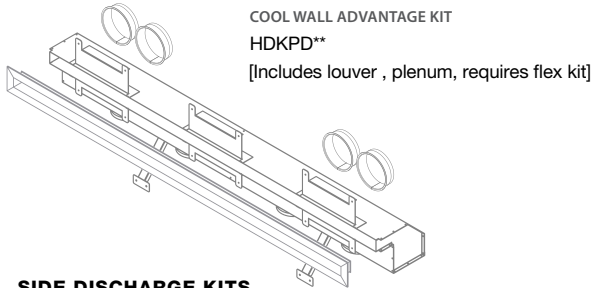

SIDE DISCHARGE KITS

Cool Wall Advantage Side Discharge Kit Horizontal [includes 2 louvers , 2 plenums, requires HDKPDFK]	HDKSD	\$439.00
Cool Wall Advantage Side Discharge Kit Vertical [includes 2 louvers , 2 plenums, requires HDKPDFK]	HDKSVD	\$439.00

COOL WALL ADVANTAGE SIDE DISCHARGE KIT HORIZONTAL

HDKSD
[Includes 2 louvers , 2 plenums, requires flex kit]

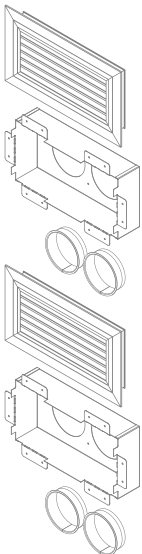

COOL WALL ADVANTAGE SIDE DISCHARGE KIT VERTICAL

HDKSVD
[Includes 2 louvers , 2 plenums, requires flex kit]

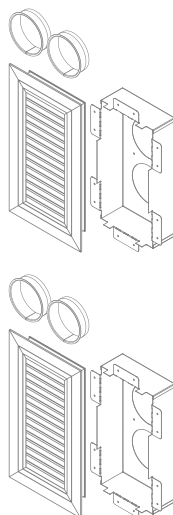

NOTE:
Cool Wall Advantage kits are only available on DelRay and Distinction units.

B Select the flex pipe:

COOL WALL SYSTEM FLEX

Cool Wall Advantage 5" X 12' Flex	HDKPDFK-1-F	\$99.00
Cool Wall Advantage 5" X 24' Flex	HDKPDFK-F	\$203.00

COOL WALL FLEX KIT

HDKPDFK
HDKPDFK-1

[HDKPDFK-1 is 12' of 5" Diameter flex pipe, HDKPDFK is 24' of 5" Diameter flex pipe]

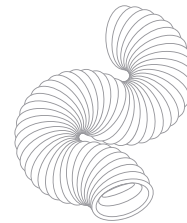

Optional venting louvers

NOTE:
Cavity venting louvers are for venting the fireplace chase without using a full Cool Wall Advantage kit.

CAVITY VENTING LOUVERS

36" Wall Cavity Venting Louver	GR36	\$77.00
48" Wall Cavity Venting Louver	GR48	\$104.00
63" Wall Cavity Venting Louver	GR63	\$134.00
72" Wall Cavity Venting Louver	GR72	\$149.00
Sidewall Cavity Venting Louver Horizontal [2 included]	GRSDH	\$129.00
Sidewall Cavity Venting Louver Vertical [2 included]	GRSDV	\$129.00

UNIT COMPATIBILITY

Cool wall system	D3615NI-2	D4815NI-2	D6315NI-2	D7215NI-2	DRL3613NI-*	DRL4813NI-*	DRL6013NI-*	DRSQ34NI-*	DRSQ38NI-*	DRSQ42NI-*	DRSQ46NI-*
HDKPD36	✓				✓			✓	✓		
HDKPD48		✓				✓				✓	✓
HDKPD63			✓				✓				
HDKPD72				✓							
HDKSD	✓	✓	✓	✓	✓	✓	✓	✓	✓	✓	✓
HDKSVD	✓	✓	✓	✓	✓	✓	✓	✓	✓	✓	✓
HDKPDFK-1	✓				✓			✓	✓		
HDKPDFK		✓	✓	✓		✓	✓			✓	✓



PAGE IS INTENTIONALLY LEFT BLANK FOR PRINTING PURPOSES
(INSERT SECTION TAB HERE)

PAGE IS INTENTIONALLY LEFT BLANK FOR PRINTING PURPOSES
(INSERT SECTION TAB HERE)

Flush Wall Mount Power Vent

MUST ORDER: **A** Power vent, **B** Power cord, **C** Harness

Harness & Reducer Compatibility:

See the next 2 pages to determine what harness kit and reducer is needed for your fireplace.

A Order the power vent:

POWER VENT

Flush Wall Mount Power Vent	PVW47	\$799.00
-----------------------------	-------	----------

B Order the power cord:

EDPV POWER CORDS

10' Power Vent System Power Cord	EPVH-10	\$129.00
20' Power Vent System Power Cord	EPVH-20	\$179.00
40' Power Vent System Power Cord	EPVH-40	\$279.00
60' Power Vent System Power Cord	EPVH-60	\$379.00
80' Power Vent System Power Cord	EPVH-80	\$479.00
100' Power Vent System Power Cord	EPVH-100	\$579.00

C Order the wiring harness:

POWER VENT WIRING HARNESS

Power Vent Wiring Harness for SIT Proflame 2 system	PVWH-SIT	\$377.00
Power Vent Capable SIT Proflame 2 Board w/Power Vent Wiring Harness	PVBWH-SIT	\$813.00

Optional accessories:

VENT REDUCER

5"/8" to 4"/7" Reducer 10" Length [male/female]	PVA5487	\$129.00
5"/8" to 4"/7" Reducing Collar [top vent only]	DRSQCOL47	\$164.00
5"/10" to 4"/7" Reducer Collar [P52DF only]	LVA54107	\$224.00

FLUE RESTRICTOR

Power Vent Adjustable Flue Restrictor [for 4"/7" vent system]	MVAFR02	\$59.00
---	---------	---------

DURAVENT 3/5 ADAPTORS (FOR POWERVENTING ONLY)

DuraVent CVS to 46DVA	35CVS-X46DVA	\$254.00
DuraVent CVS to 58DVA	35CVS-X58DVA	\$274.00
DuraVent 46DVA to CVS	46DVA-X35CVS	\$248.00
DuraVent 58DVA to CVS	58DVA-X35CVS	\$274.00

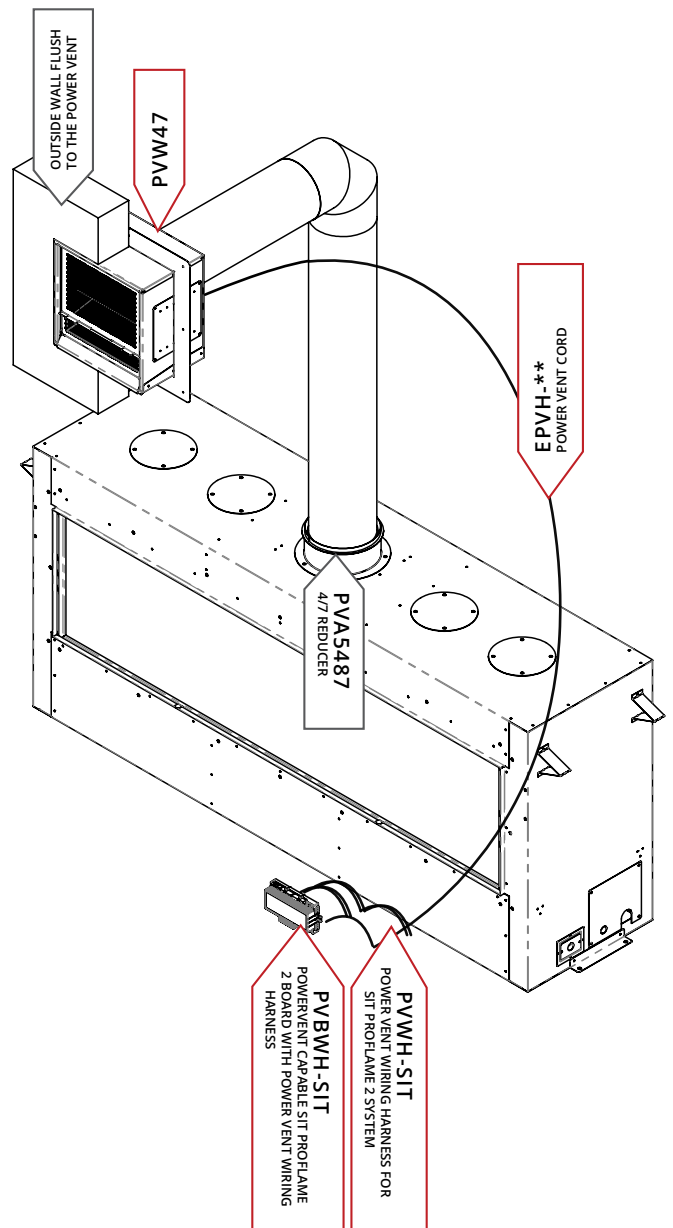



Wall and Roof Mount Power Vent 200

MUST ORDER: **A** Power vent, **B** Power cord, **C** Harness

Harness & Reducer Compatibility:

See the next 2 pages to determine what harness kit and reducer is needed for your fireplace.

A Order the power vent:

POWER VENT

Roof Termination & Fan Motor 4"/7" [includes speed control PVFCB] [includes speed control PVFCB]	PVVEX47-200	\$3,147.00
---	-------------	------------

POWER VENT

Wall Termination & Fan Motor 4"/7" [includes speed control PVFCB] [includes speed control PVFCB]	PVHEX47-200	\$2,376.00
---	-------------	------------

B Order the power cord:

EDPV POWER CORDS

10' Power Vent System Power Cord	EPVH-10	\$129.00
20' Power Vent System Power Cord	EPVH-20	\$179.00
40' Power Vent System Power Cord	EPVH-40	\$279.00
60' Power Vent System Power Cord	EPVH-60	\$379.00
80' Power Vent System Power Cord	EPVH-80	\$479.00
100' Power Vent System Power Cord	EPVH-100	\$579.00

C Order the wiring harness:

POWER VENT WIRING HARNESS

Power Vent Wiring Harness for SIT Proflame 2 system	PVWH-SIT	\$377.00
Power Vent Capable SIT Proflame 2 Board w/Power Vent Wiring Harness	PVBWH-SIT	\$813.00

Optional accessories:

VENT REDUCER

5"/8" to 4"/7" Reducer 10" Length [male/female]	PVA5487	\$129.00
5"/8" to 4"/7" Reducing Collar [top vent only]	DRSQCOL47	\$164.00
5"/10" to 4"/7" Reducer Collar [P52DF only]	LVA54107	\$224.00

FLUE RESTRICTOR

Power Vent Adjustable Flue Restrictor [for 4"/7" vent system]	MVAFR02	\$61.00
---	---------	---------

DURAVENT 3/5 ADAPTORS (FOR POWERVENTING ONLY)

DuraVent CVS to 46DVA	35CVS-X46DVA	\$254.00
DuraVent CVS to 58DVA	35CVS-X58DVA	\$274.00
DuraVent 46DVA to CVS	46DVA-X35CVS	\$248.00
DuraVent 58DVA to CVS	58DVA-X35CVS	\$274.00

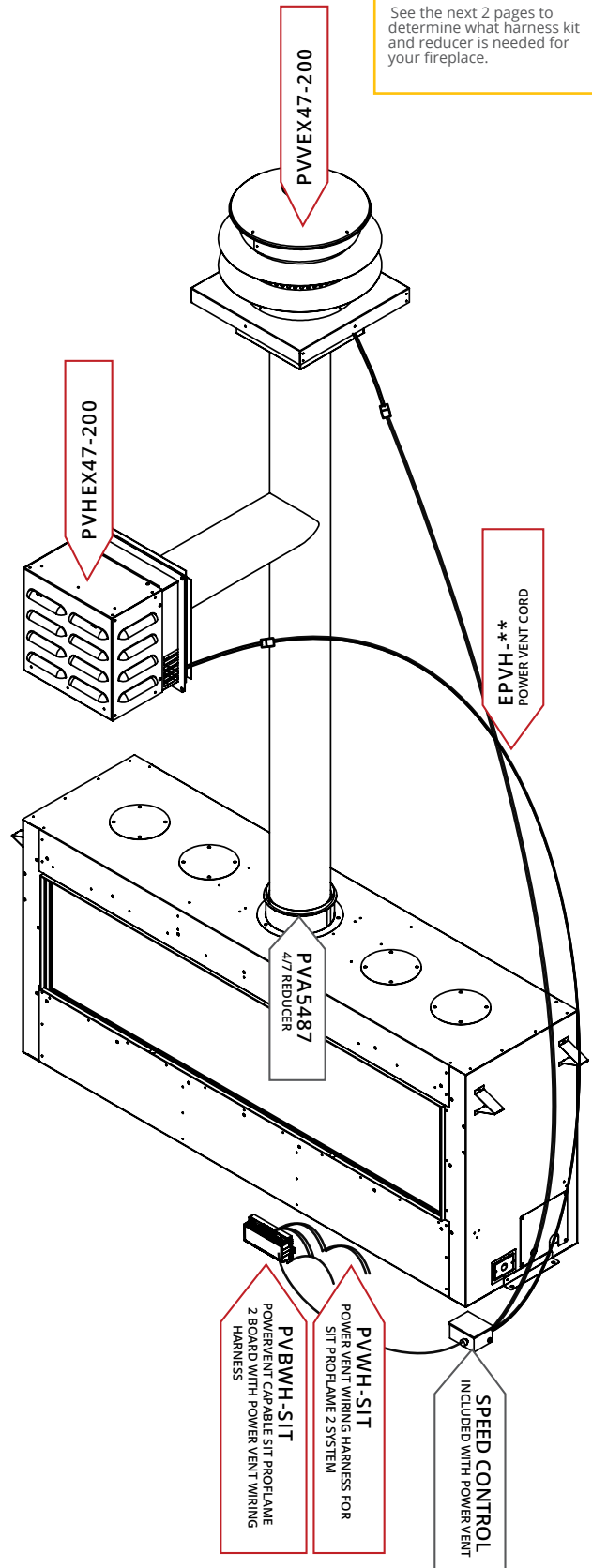

Inline Power Vent 200

Harness & Reducer Compatibility:

See the next 2 pages to determine what harness kit and reducer is needed for your fireplace.

MUST ORDER: **A** Power vent, **B** Power cord, **C** Harness

A Order the power vent:

POWER VENT

4"/7" Inline Power Vent [includes speed control PVFCB] [includes speed control PVFCB]	PVHIN47-200	\$2,375.00
---	-------------	------------

B Order the termination:

TERMINATIONS

4"/7" Flush Horizontal Termination	TMHIN47-24	\$1,379.00
4"/7" Flush Vertical Termination	TMVIN47-12	\$1,449.00
Stainless Termination for Vertical Installations [includes MXT10 adapter, for straight, vertical installations]	MVTK1SS	\$299.00
4"/7" Termination Horizontal 4" Length for Power Vent	MTO4-PV	\$494.00
4"/7" Termination Horizontal 4" Length w/ Frame for Power Vent	MTO4F-PV	\$539.00
4"/7" Stainless Termination Horizontal 4" for Power Vent	MTO4SS-PV	\$579.00
4"/7" Stainless Termination Horizontal 4 " w/ Frame for Power Vent	MTO4FSS-PV	\$619.00

B Order the power cord:

EDPV POWER CORDS

10' Power Vent System Power Cord	EPVH-10	\$129.00
20' Power Vent System Power Cord	EPVH-20	\$179.00
40' Power Vent System Power Cord	EPVH-40	\$279.00
60' Power Vent System Power Cord	EPVH-60	\$379.00
80' Power Vent System Power Cord	EPVH-80	\$479.00
100' Power Vent System Power Cord	EPVH-100	\$579.00

C Order the wiring harness:

POWER VENT WIRING HARNESS

Power Vent Wiring Harness for SIT Proflame 2 system	PVWH-SIT	\$377.00
Power Vent Capable SIT Proflame 2 Board w/Power Vent Wiring Harness	PVBWH-SIT	\$813.00

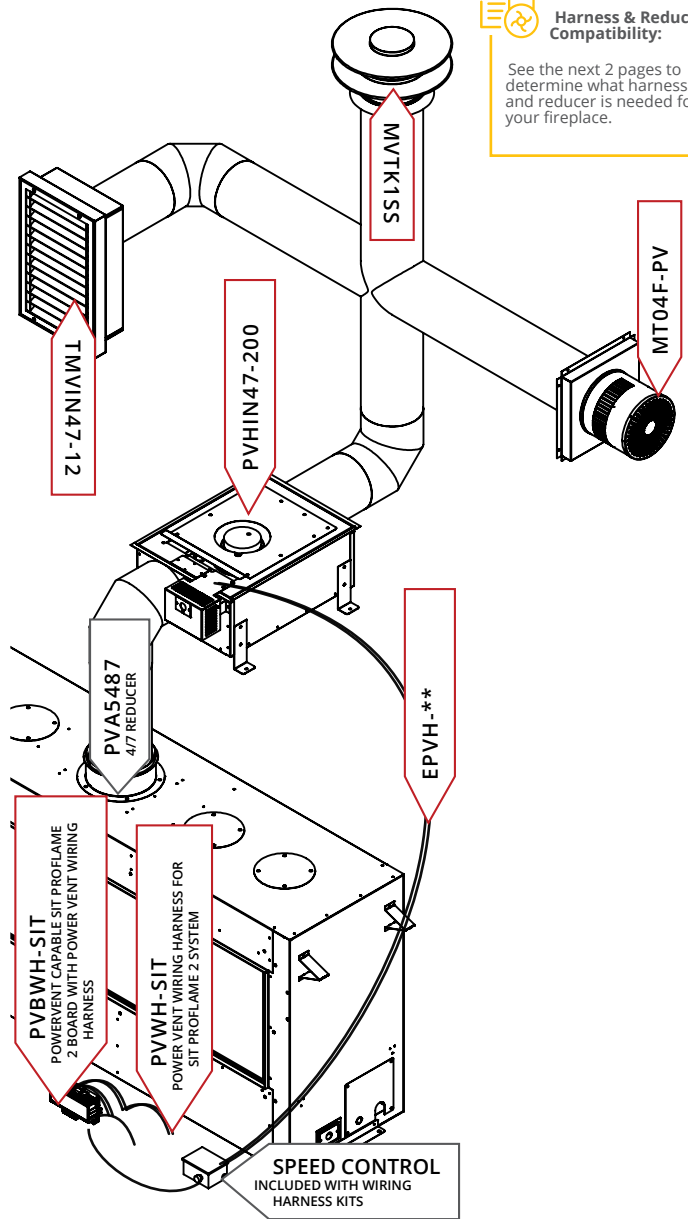

VENT REDUCER

5"/8" to 4"/7" Reducer 10" Length [male/female]	PVA5487	\$129.00
5"/8" to 4"/7" Reducing Collar [top vent only]	DRSQCOL47	\$164.00
5"/10" to 4"/7" Reducer Collar [P52DF only]	LVA54107	\$224.00

DURAVENT 3/5 ADAPTORS (FOR POWERVENTING ONLY)

DuraVent CVS to 46DVA	35CVS-X46DVA	\$254.00
DuraVent CVS to 58DVA	35CVS-X58DVA	\$274.00
DuraVent 46DVA to CVS	46DVA-X35CVS	\$248.00
DuraVent 58DVA to CVS	58DVA-X35CVS	\$274.00

Optional accessories:

FLUE RESTRICTOR

Power Vent Adjustable Flue Restrictor [for 4"/7" vent system]	MVAFR02	\$61.00
---	---------	---------



Power Vent Compatibility

	HARNESSES/HARNESSES+ BOARD REQUIRED	REDUCER REQUIRED
DRL3613NI	PVBWH-SIT	NO
DRL3613NI-2	PVWH-SIT	NO
DRL4813NI	PVBWH-SIT	NO
DRL4813NI-2	PVWH-SIT	NO
DRL6013NI	PVBWH-SIT	NO
DRL6013NI-2	PVWH-SIT	NO
DRL7213NI	PVBWH-SIT	NO
DRL7213NI-2	PVWH-SIT	NO
DRSQ34NI	PVBWH-SIT	NO
DRSQ34NI-2	PVWH-SIT	NO
DRSQ38NI-2	PVWH-SIT	PVA5487
DRSQ38NI	PVBWH-SIT	PVA5487
DRSQ42NI-2	PVWH-SIT	PVA5487
DRSQ42NI	PVBWH-SIT	PVA5487
DRSQ46NI-2	PVWH-SIT	PVA5487
DRSQ46NI	PVBWH-SIT	PVA5487
D3615NI-2	PVWH-SIT	PVA5487
D4815NI-2	PVWH-SIT	PVA5487
D6315NI-2	PVWH-SIT	PVA5487
D7215NI-2	PVWH-SIT	PVA5487
D3615STNI-2	PVWH-SIT	PVA5487
D4815STNI-2	PVWH-SIT	PVA5487
D6315STNI-2	PVWH-SIT	PVA5487
D7215STNI-2	PVWH-SIT	PVA5487
H38FSD*	-	-
H38FSD*1	PVBWH-SIT	PVA5487
H42FSD*	-	-
H42FSD*1	PVBWH-SIT	PVA5487
H38PF*1-2	PVWH-SIT	PVA5487
HL38PF*1-2	PVWH-SIT	PVA5487
H38CL*1-2	PVWH-SIT	PVA5487
H38CR*1-2	PVWH-SIT	PVA5487
HL38CL*1-2	PVWH-SIT	PVA5487
HL38CR*1-2	PVWH-SIT	PVA5487

	HARNESSES/HARNESSES+ BOARD REQUIRED	REDUCER REQUIRED
R320*	NO	NO
R420*	NO	NO
R520*	NO	NO
R720*	NO	NO
R820*	NO	NO
R320ST*	NO	NO
R420ST*	NO	NO
R520ST*	NO	NO
R620ST*	NO	NO
RP620*	NO	NO
RP424PF*	NO	NO
R324STIO*	-	-
P38DF*1-2	PVWH-SIT	PVA5487
P42DF*1-2	PVWH-SIT	PVA5487
P52DF*1-2	PVWH-SIT	LVA54107
PL38DF*1-2	PVBWH-SIT	PVA5487
PL42DF*1-2	PVBWH-SIT	PVA5487
PL52DF*1-2	PVBWH-SIT	LVA54107
L38FSD*	-	-
L38FSD*1	PVWH-SIT	PVA5487
L42FSD*	-	-
L42FSD*1	PVWH-SIT	PVA5487
L52FSD*	-	-
L52FSD*1	PVWH-SIT	PVA5487
30FID*1S-01	-	-
34FID*1S-01	-	-



Harness Kits

PVBWH-SIT

- IFC Control board
 - SIT PN: 0.584.665
 - Montigo PN: GC3104
- Wiring Harness

This kit is designed to power vent fireplaces that were shipped with a Proflame 2 BASIC control board. The PVBWH-SIT kit contains a full load board as well as a power vent wiring harness.

PVWH-SIT

- Wiring Harness

This kit is designed to power vent fireplaces that already have a Proflame 2 control board. The PVWH-SIT kit contains a power vent wiring harness and requires the removal of the power vent jumper from the existing control board.

Additional Components

- 200 Series power vent
 - PVVEX47-200
 - PVHEX47-200
 - PVHIN47-200
- Power Vent system power cord
 - EPVH-10
 - EPVH-20
 - EPVH-40
 - EPVH-60
 - EPVH-80
 - EPVH-100

Reducers

PVA5487

- For reducing 5/8 venting to 4/7

LVA54107

- For reducing 5/10 venting to 4/7

All 200 series power vents use 4/7 venting, therefore fireplaces that use 5/8 or 5/10 venting must be reduced.

Restrictor

MVAFR02

- 4/7 vent restrictor

The use of a power vent necessitates the use of a restrictor, especially on straight vertical runs.

PAGE IS INTENTIONALLY LEFT BLANK FOR PRINTING PURPOSES
(INSERT SECTION TAB HERE)

PAGE IS INTENTIONALLY LEFT BLANK FOR PRINTING PURPOSES
(INSERT SECTION TAB HERE)

Designer Burner Accessories

Decorative media:

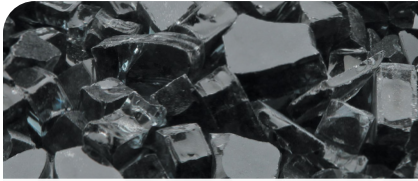

OBSIDIAN



AMBER



FIBER EMBERS

GLOWING NEON EMBERS



FROST



PLATINUM



GLACIER



QUARTZ



ICE



ALABASTER

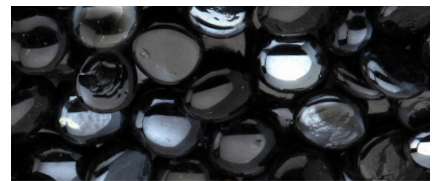

EBONY



COPPER



ONYX

EMBERS

Fiber Embers	REMBERS	\$56.00
Glowing Neon Embers	RNEMBERS	\$14.00

FIREGLASS 3LB BAGS

Obsidian 3lb	HW1113	\$55.00
Platinum 3lb	HW1144	\$55.00
Ice 3lb	HW1157	\$32.00
Copper 3lb	HW1143	\$55.00

FIREGLASS 1LB BAGS

Obsidian 1lb	HW1113-1	\$19.00
Platinum 1lb	HW1144-1	\$19.00
Ice 1lb	HW1157-1	\$16.00
Copper 1lb	HW1143-1	\$19.00

FIRESTONES 3LB BAGS

Amber 3lb	HW1261	\$65.00
Glacier 3lb	HW1219B	\$65.00
Alabaster 3lb	HW1260	\$65.00
Onyx 3lb	HW1259	\$65.00

FIRESTONES 1LB BAGS

Amber 1lb	HW1261-1	\$26.00
Glacier 1lb	HW1219B-1	\$26.00
Alabaster 1lb	HW1260-1	\$26.00
Onyx 1lb	HW1259-1	\$26.00

FIREBEADS 3LB BAGS

Frost 3lb	HW1112	\$23.00
Quartz 3lb	HW1106	\$23.00
Ebony 3lb	HW1091	\$23.00

FIREBEADS 1LB BAGS

Frost 1lb	HW1112-1	\$17.00
Quartz 1lb	HW1106-1	\$18.00
Ebony 1lb	HW1091-1	\$17.00



Miscellaneous Components

HOME AUTOMATION

Smart Home Automation Fireplace Control	HAFC	\$229.00
---	------	----------

The HAFC home automation control is used as a intermediary switch when connecting a home automation system to the fireplace. The HAFC provides a dry contact switch to **separate the home electrical system from the fireplace controls**. HAFC can be used with any fireplace control such as millivolt, IPI and 24VAC. On/Off is the only functionality supported.

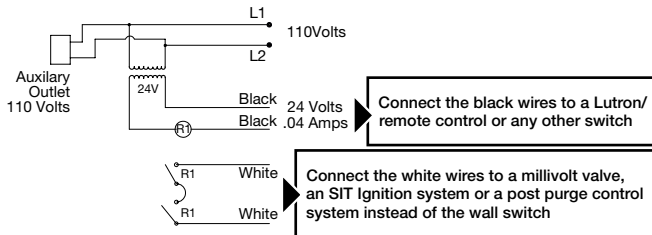

CONSUMABLES

MilPack 300ml	IN2013	\$47.00
Satin Black Touch Up Paint - 12oz	PAINT01HT	\$48.00
White Off Glass Cleaner	RT565	\$38.00

ARMORED POWERVENT CABLES

10' Armored EDVPV Power Vent Power Cord	EPVHA-10	\$208.00
20' Armored EDVPV Power Vent Power Cord	EPVHA-20	\$323.00
40' Armored EDVPV Power Vent Power Cord	EPVHA-40	\$536.00
60' Armored EDVPV Power Vent Power Cord	EPVHA-60	\$741.00
80' Armored EDVPV Power Vent Power Cord	EPVHA-80	\$1,025.00
100' Armored EDVPV Power Vent Power Cord	EPVHA-100	\$1,230.00

BOARD ANTENNA

Proflame 2 Board Antenna	REC1491	\$46.00
--------------------------	---------	---------

NEW PRODUCT

PROFLAME 2 WIFI DONGLE

Proflame 2 WiFi Dongle	SIT-WIFI	\$244.00
------------------------	----------	----------

What is needed

In order to operate the fireplace with the Proflame Connect app via WiFi, 4 components are needed. If any of these items are missing/not installed then the wifi connect process will not be successful.

IFC Control board

SIT PN: 0.584.665

Montigo PN: GC3104

The control board must be the version with the electrical schematic printed in green.

SIT Proflame2 Connect enabled remote

SIT PN: 0.584.080 (handheld remote)

Montigo PN: GC3105 (handheld remote)

SIT PN: 0.584.090 (wall mounted remote)

Montigo PN: EC1550 (wall mounted remote)

This can be identified by the "connect" icon on the upper right corner of the label.

Proflame Connect App (not Proflame Connect Plus)

Android and iOS applications can be found in their respective stores: Play Store and App Store.

WiFi Dongle

This is plugged into the diagnostic port of the IFC control board.

SIT PN: 0.584.526

Montigo PN: SIT-WIFI

