

Majestic

MSRP Price Book Table of Contents

Majestic

Fireplace - Gas - Single-Sided

Echelon II 36	4
Echelon II 48	7
Echelon II 60	10
Echelon II 72	13
Jade 32	16
Jade 42	19
Marquis II 36 IFT	22
Marquis II 42 IFT	24
Mercury 32	26
Meridian 36	27
Meridian 36 Modern	30
Meridian 36 Platinum	33
Meridian 42	36
Meridian 42 Modern	39
Meridian 42 Platinum	42
Quartz 32 w/ IFT	45
Quartz 36 Platinum	47
Quartz 36 w/ IFT	49
Quartz 42 w/ IFT	51

Fireplace - Gas - Freestanding

Ruby Freestanding 30"	53
Trilliant Freestanding 30"	55

Fireplace - Gas - Multi-Sided

Echelon II 36ST	57
Echelon II 48ST	60
Marquis II See-Through 42	63

Fireplace - Wood - Single-Sided

Ashland 36	65
Ashland 42	67
Ashland 50	70
Biltmore 36	72
Biltmore 42	76
Biltmore 50	80
Royalton 36	84
Royalton 42	87
Sovereign 36	90
Sovereign 42	93
WarmMajic-II	96

Fireplace - Wood - Multi-Sided

Designer Series See-Through 42	98
------------------------------------------------	----

Insert - Gas

Jasper Insert 30"	100
Ruby Insert 25"	103
Ruby Insert 30"	106
Ruby Insert 35"	109
Trilliant Insert 25"	112
Trilliant Insert 30"	115
Trilliant Insert 35"	118

Hearth & Home Technologies

Gas Logs - Log Set Option

Campfire Gas Log Sets	121
Duzy Series Gas Log Sets	122
Fireside Grand Oak Gas Log Sets	123
Fireside Grand Oak Outdoor Gas Log Sets	124
Fireside Realwood Gas Log Sets	125
Fireside Realwood Outdoor Gas Log Sets	126
Fireside Supreme Oak Gas Logs	127
Fireside Supreme Oak See-Through Gas ...	128
Gas Logs - Burner Option (OD)	129

Hearth & Home Technologies

Power Vent

Power Vent	130
Powervent	130
Power Vent Accessories	130

Wire Harness

Wire Harness	132
------------------------------	-----

Venting

Air Kits	133
Decorative Termination Caps/Shrouds	133
8" DuraPlus Pipe	133
Fireplace - Wood & Coal Venting	134
Gas Fireplace - 5" B-Vent	134
Gas Fireplace - 6" B-Vent	135
Gas Fireplace - 8" B-Vent	137
Gas Fireplace - 10" B-Vent	138
Gas Fireplace - DVP Venting	139
Gas Fireplace - Flex Venting	141
Gas Fireplace - Term./Shrouds	141
Gas Fireplace/Stove - SLP Venting	142
Gas Insert - Venting	144
Outside Kits	145
SLP and DVP - Shield/Flashing/Collars	145

Venting-cont'd			
Stove & Insert - Pellet	145	Acadia A	213
Venting - VCG	149	Acadia B	213
Stove - Pellet Chimney	150	Acadia C	213
Venting - VMT	150	Battlefield B	214
Stoves & inserts - Wall Pass Thru	150	Battlefield C	214
Top Vent option	150	Corbels	214
Wood Fireplace - 14" DuraChimney II V...	151	Kenwood A	214
Wood Fireplace - SL1100 Series Venting	151	Kenwood B	214
Wood Fireplace - SL300 Series Venting	153	Kenwood B60	215
Wood Fireplace - SL400 Series Venting	154	Kenwood C	215
Wood Insert Venting	155	Laurel B	215
Wood Stove Venting	156	Laurel C	215
Venting - HHT	159	Malone B	216
Termination Kits		Malone C	216
Termination Kits	161	Merritt A	216
Hearth & Home Technologies		Merritt B	216
Fireplace - Gas - Single-Sided		Merritt C	216
DV Linear 36	163	Richland A	217
DV3732	165	Richland B	217
DV4236	166	Richland C	217
Reveal 36	167	Richland RS	217
Reveal 42	169	Roxborough A	217
Fireplace - Gas - Multi-Sided		Roxborough B	218
Corner Gas Fireplace L/R-COR	171	Roxborough C	218
Pier 36	173	Walker B	218
See Through 36	176	Walker C	218
Fireplace - Wood - Single-Sided		Wescott A	218
Pioneer II	179	Wescott B	219
Pioneer III	181	Wescott C	219
Fireplace Outdoor - Gas - Single-Sided		Zimmer A	219
Courtyard 36	183	Zimmer B	219
Courtyard 42	185	Zimmer C	219
Lanai 48	187	Optional Wood Mantel Base	
Lanai 60	189	Kenwood A Flush Mantel Base	221
Vesper 36	191	Kenwood B Flush Mantel Optional Base	221
Vesper 42	193	Kenwood C Flush Mantel Optional Base	221
Fireplace Outdoor - Wood - Single-Sided		Samples - Wood Mantel Shoulder	
Castlewood 42	195	Acadia Mantel Sample	222
Cottagewood 36	197	Battlefield Mantel Sample	222
Cottagewood 42	199	Kenwood Wood Mantel Sample - Primed MDF	222
Villawood 36	201	Laurel Mantel Sample	222
Villawood 42	203	Malone Mantel Sample	222
Fireplace Outdoor - Gas - Multi-Sided		Merritt Mantel Sample	223
Fortress 36 Indoor/Outdoor See-Through...	205	Richland Mantel Sample	223
Lanai 48 See-Through	207	Roxborough Mantel Sample	223
Twilight Indoor/Outdoor See-Through G...	209	Walker Mantel Sample	223
Twilight Modern	211	Wescott Mantel Sample	223
Hearth & Home Technologies		Zimmer Mantel Sample	223

Samples - Non-Combustible Shelf Shoulder

Non-Combustible Cove Gray 18"	225
Non-Combustible Midnight Mist 18"	225
Non-Combustible Tavern Brown 18"	225
Non-Combustible Washed Cedar 18"	225
Non-Combustible Weathered Barnwood 18"	225
Non-Combustible White 18"	226

Mantels - Shelf Wood

Baxter 48"	227
Baxter 59"	227
Baxter 72"	227
Crosby 48"	228
Crosby 59"	228
Crosby 72"	228
Fillmore 48"	228
Fillmore 59"	228
Fillmore 72"	229
Ozark 48"	229
Ozark 59"	229
Ozark 72"	229

Shelf Non-Combustible

Non-Combustible Cove Gray 60"	230
Non-Combustible Cove Gray 72"	230
Non-Combustible Midnight Mist 60"	230
Non-Combustible Midnight Mist 72"	230
Non-Combustible Tavern Brown 60"	230
Non-Combustible Tavern Brown 72"	231
Non-Combustible Washed Cedar 60"	231
Non-Combustible Washed Cedar 72"	231
Non-Combustible Weathered Barnwood 60"	231
Non-Combustible Weathered Barnwood 72"	231
Non-Combustible White 60"	232
Non-Combustible White 72"	232

Samples - Wood Shelf Mantel

Baxter Shelf Sample	233
Crosby Shelf Sample	233
Fillmore Shelf Sample	233
Ozark Shelf Sample	233

Marble, Granite & Slate

Absolute Black Granite Set 1	234
Absolute Black Granite Set 2	234
Absolute Black Set 3	234
Beige Marble Set 1	235
Beige Marble Set 2	235
Beige set 3	235
Bianco White set 1	235
Bianco White set 2	235
Bianco White set 3	236
Blue Tundra set 1	236

Marble, Granite & Slate-cont'd

Blue Tundra set 2	236
Blue Tundra set 3	236
Driftwood 55 x 6 Linear Header, Riser	236
Driftwood 75.25 x 6 Linear Header, riser	237
Driftwood Linear Legs (2)	237
Driftwood set 1	237
Driftwood set 2	237
Driftwood set 3	237
New Venetian Granite Set 1	238
New Venetian Granite Set 2	238
New Venetian set 3	238
Parchwood set 1	238
Parchwood set 2	238
Parchwood set 3	239
Pauline Granite Set 1	239
Pauline Granite Set 2	239
Pauline Granite Set 3	239
Slate 37.25X7	239
Slate 51X8	240
Slate 57X8	240
Slate 60X20	240
Slate 70x20"	240
Steel Gray Granite set 1	240
Steel Gray set 2	241
Steel Gray set 3	241
Thala Beige set 1	241
Thala Beige set 2	241
Thala Beige set 3	241

Majestic	Fireplace - Gas - Single-Sided	Stocked Item/Lead Time 004=Mt. Pleasant RDC 010=Kutztown RDC 014=Sacramento RDC 016=Charlotte RDC EXP=Factory Expedite Program
-----------------	---------------------------------------	---------------------------------------------------------------------------------------------------------------------------------------------------

Page printed 2/1/2024 3:05:35 PM CST
 Future pricing effective for shipments on or after 03/31/2024
 * Please Contact Who You Purchase This Through for MSRP Pricing

Prices in USD
 Non-stock and custom product cannot be cancelled.
 Customer is responsible for freight for orders made outside of assigned RDC facility.

Echelon II 36

- Includes:
- 17,500 - 30,000 Btu/Hour Input (NG)
 - 15-000 - 27,000 Btu/Hour Input (LP)
 - Clear LED dimmable lights
 - RC400 remote control
 - Battery backup
 - Ceramic glass
 - Standard with bronze glass media
 - IntelliFire Touch ignition system
 - Not available for sale in Rhode Island
 - If changing media, follow required number of bags below:
 - -- > Crushed Glass: 3 bags of glass
 - -- > Natural stones: 2 bags of stone
 - -- > Log set & stones: 1 bag of stone



Required to Complete - Sold Separately: • Front

		Disc.	MSRP	004	010	014	016	EXP
		Code	USD	IA	PA	CA	NC	
ECHEL36IN-C	Echelon II 36" top direct vent fireplace with IntelliFire Touch Ignition System (NG)	MAJ 1	\$ 4,529	14	Y	14	14	N

Fronts - Non-Operable (Required to Complete)

Clean Face Trim

CFT-36-BK-C	Clean face trim - Black	HTI 1	\$ 429	Y	Y	Y	Y	Y
CFT-36-BZ-C	Clean face trim - Bronze	HTI 1	\$ 479	14	14	14	14	Y
CFT-36-PT-C	Clean face trim - Pewter	MAJ 1	\$ 479	14	14	14	14	Y

Picture Frame Front

PFF-36-CH-C	Picture frame front - Charcoal	MAJ 1	\$ 739	14	14	14	14	Y
-------------	--------------------------------	-------	--------	----	----	----	----	---



Clean Face Trim



Picture Frame Front

Conversion Kit

Conversion Kits

LPK-ECHEL36	CONVERSION KITS, LP	MAJ 1	\$ 99	14	21	14	14	Y
-------------	---------------------	-------	-------	----	----	----	----	---

Gas Logs - Log Set Option**Driftwood Log Set**

LOGS-DRTWOOD-36	Driftwood log set	MAJ 1	\$ 389	Y	14	14	14	14	Y
-----------------	-------------------	-------	--------	---	----	----	----	----	---

Media**Media**

GLASS-BZ	Glass, Bronze (1 bag)	MAJ 1	\$ 71	Y	21	14	14	Y
GLASS-DM	Glass, Diamond (1 bag)	MAJ 1	\$ 71	Y	Y	14	Y	Y
GLASS-OY	Glass, Onyx (1 bag)	MAJ 1	\$ 71	Y	Y	14	Y	Y
GLASS-SP	Glass, Sapphire (1 bag)	MAJ 1	\$ 71	Y	Y	14	14	Y

Stones

STONES-NATURAL	Natural stones (1 bag)	HTI 1	\$ 111	Y	Y	Y	Y	Y
----------------	------------------------	-------	--------	---	---	---	---	---

Liner Kit**Black Glass Liner Kit**

BGK-36	Reflective black ceramic glass liner kit	HTI 1	\$ 669	14	14	14	14	Y
--------	------------------------------------------	-------	--------	----	----	----	----	---

Heat Management**Heat Management**

PH-FRT	Passive Heat kit for front or top discharge	HTI 1	\$ 169	Y	Y	Y	Y	Y
PHTRIM-36C	Vent trim for front discharge (Requires PH-FRT Passive Heat Kit)	HTI 1	\$ 219	14	14	14	14	Y
PH-SIDE	Passive Heat kit for side discharge (includes 2 side registers)	HTI 1	\$ 239	Y	Y	Y	Y	Y

Heat Management - Ducted

PHTRIM-MCE-36	Ducted vent trim for front discharge using ducted Passive Heat (PHFR-MCE-36)	HTI 1	\$ 239	14	14	14	14	Y
PHSI-MCE	Ducted Passive Heat kit for side discharge (includes duct and 2 side registers)	HTI 1	\$ 549	14	21	14	14	Y
PHFR-MCE-36	Ducted Passive Heat kit for front discharge (requires PHTRIM-MCE-36 front trim)	HTI 1	\$ 609	14	14	14	14	Y

Heat Out Kit

HEAT-OUT-GAS	Heat out kit (includes termination cap, 25' of 6" round duct, fireplace adapter, damper, wall switch and 350CFM fan at termination)	HTI 1	\$ 1,489	Y	14	Y	14	Y
--------------	-------------------------------------------------------------------------------------------------------------------------------------	-------	----------	---	----	---	----	---

Heat Zone Kit

HZLIN-ADP	Heat Zone adaptor, must order for using HEAT-ZONE-GAS	HTI 1	\$ 169	Y	Y	Y	14	Y
HEAT-ZONE-GAS	Heat-Zone Kit includes fan, 20' of 6" round duct, vent, wall adapter & on/off control. Wire Plug Assembly 26D0619 required if controlling w/RC400 remote. Used in IFT units with ACM & not a GFK fan. Compatible for up to 2 HEAT-ZONE-GAS kits. See manual.	HTI 1	\$ 549	Y	Y	Y	Y	Y

Control, remotes, wall switches**Battery Back Up**

BATTERY-WSK	Battery backup wall switch kit for units with IFT control systems. Includes: On/Off Wall Switch, USB-C Port, Battery Backup, Cover Plate, 12' Wire Harness	HTI 1	\$ 179	Y	14	14	14	Y
-------------	------------------------------------------------------------------------------------------------------------------------------------------------------------	-------	--------	---	----	----	----	---

IntelliFire app

IFT-WFM	IntelliFire Wi-Fi Module that works with the IntelliFire iOS and Android app. Use to control all the features of your fireplace via a smart device. An RC400, RC450 or RC150 is required for thermostat control	HTI 1	\$ 219	Y	Y	Y	Y	Y
---------	-----------------------------------------------------------------------------------------------------------------------------------------------------------------------------------------------------------------	-------	--------	---	---	---	---	---

Remote/Wall Switch/Wall Thermostat

IFT-RC150	IntelliFire Touch white wireless wall switch (on/off, cold climate, battery strength indicator)	HTI 1	\$	116	Y	14	14	Y	Y
-----------	-------------------------------------------------------------------------------------------------	-------	----	-----	---	----	----	---	---

Touch Screen Remote

IFT-RC400	IntelliFire Touch black remote control, docking station and auxiliary control module (on/off, flame height, thermostat mode, fan control, child lock, cold climate, timer mode, hot indicator, lights, on-screen maintenance and troubleshooting notifications)	HTI 1	\$	379	Y	Y	Y	Y	Y
-----------	-----------------------------------------------------------------------------------------------------------------------------------------------------------------------------------------------------------------------------------------------------------------	-------	----	-----	---	---	---	---	---



Battery Back Up



IntelliFire app

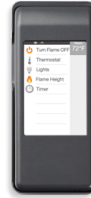

Touch Screen Remote

Venting

Brick Extension Kit

HEAT-OUT-BEK	Exterior Heat-Zone brick extension kit	HTI 1	\$	71	8	21	21	14	Y
--------------	----------------------------------------	-------	----	----	---	----	----	----	---

Venting Notes

Requires 8" DVP pipe. Must have a 18" minimum vertical vent before attaching a 90° elbow to unit. See venting section of manual.

Approved for use with PVL-PSLP, PVI-SLP-B and PVV-SLP with power vent wire harness (order separately) and IFT-RC400 remote. See venting section of manual.

Echelon II 48

Includes:

- 21,000 - 40,000 Btu/Hour Input (NG)
- 20,000 - 34,000 Btu/Hour Input (LP)
- Clear LED dimmable lights
- RC400 remote control
- Battery backup
- Ceramic glass
- Standard with bronze glass media
- IntelliFire Touch ignition system
- If changing media, follow required number of bags below:
 - -- > Crushed Glass: 4 bags of glass
 - -- > Natural stones: 3 bags of stone
 - -- > Log set & stones: 1 bag of stone



Required to Complete - Sold Separately: • Front

		Disc. Code	MSRP USD	004 IA	010 PA	014 CA	016 NC	EXP
ECHEL48IN-C	Echelon II 48" top direct vent fireplace with IntelliFire Touch Ignition System (NG)	MAJ 1	\$ 5,719	Y	Y	14	14	N

Fronts - Non-Operable (Required to Complete)

Clean Face Trim

CFT-48-BK-C	Clean face trim - Black	HTI 1	\$ 459	Y	Y	Y	Y	Y
CFT-48-BZ-C	Clean face trim - Bronze	HTI 1	\$ 499	14	14	14	14	Y
CFT-48-PT-C	Clean face trim - Pewter	MAJ 1	\$ 499	14	14	14	14	Y

Picture Frame Front

PFF-48-CH-C	Picture frame front - Charcoal	MAJ 1	\$ 839	14	14	14	14	Y
-------------	--------------------------------	-------	--------	----	----	----	----	---



Clean Face Trim



Picture Frame Front

Conversion Kit

Conversion Kits

LPK-ECHEL48	CONVERSION KIT, LP	MAJ 1	\$ 99	28	21	14	14	Y
-------------	--------------------	-------	-------	----	----	----	----	---

Gas Logs - Log Set Option

Driftwood Log Set

LOGS-DRTWOOD-48	Driftwood log set	MAJ 1	\$ 509	Y	Y	14	14	Y
-----------------	-------------------	-------	--------	---	---	----	----	---

Media

Media

GLASS-SP	Glass, Sapphire (1 bag)	MAJ 1	\$ 71	Y	Y	14	14	Y
GLASS-OY	Glass, Onyx (1 bag)	MAJ 1	\$ 71	Y	Y	14	Y	Y
GLASS-DM	Glass, Diamond (1 bag)	MAJ 1	\$ 71	Y	Y	14	Y	Y
GLASS-BZ	Glass, Bronze (1 bag)	MAJ 1	\$ 71	Y	21	14	14	Y

Stones									
STONES-NATURAL	Natural stones (1 bag)	HTI 1	\$	111	Y	Y	Y	Y	Y
Liner Kit									
Black Glass Liner Kit - 48									
BGK-48	Reflective black ceramic glass liner kit	HTI 1	\$	799	Y	Y	14	Y	Y
Heat Management									
Heat Management									
PH-FRT	Passive Heat kit for front or top discharge	HTI 1	\$	169	Y	Y	Y	Y	Y
PHTRIM-48C	Vent trim for front discharge (Requires PH-FRT Passive Heat Kit)	HTI 1	\$	219	Y	Y	Y	Y	Y
PH-SIDE	Passive Heat kit for side discharge (includes 2 side registers)	HTI 1	\$	239	Y	Y	Y	Y	Y
Heat Management - Ducted									
PHTRIM-MCE-48	Ducted vent trim for front discharge using ducted Passive Heat (PHFR-MCE-48)	HTI 1	\$	259	14	14	14	Y	N
PHSI-MCE	Ducted Passive Heat kit for side discharge (includes duct and 2 side registers)	HTI 1	\$	549	14	21	14	14	Y
PHFR-MCE-48	Ducted Passive Heat kit for front discharge (requires PHTRIM-MCE-48 front trim)	HTI 1	\$	669	14	14	Y	Y	Y
Heat Out Kit									
HEAT-OUT-GAS	Heat out kit (includes termination cap, 25' of 6" round duct, fireplace adapter, damper, wall switch and 350CFM fan at termination)	HTI 1	\$	1,489	Y	14	Y	14	Y
Heat Zone Kit									
HZLIN-ADP	Heat Zone adaptor, must order for using HEAT-ZONE-GAS	HTI 1	\$	169	Y	Y	Y	14	Y
HEAT-ZONE-GAS	Heat-Zone Kit includes fan, 20' of 6" round duct, vent, wall adapter & on/off control. Wire Plug Assembly 26D0619 required if controlling w/RC400 remote. Used in IFT units with ACM & not a GFK fan. Compatible for up to 2 HEAT-ZONE-GAS kits. See manual.	HTI 1	\$	549	Y	Y	Y	Y	Y
Control, remotes, wall switches									
Battery Back Up									
BATTERY-WSK	Battery backup wall switch kit for units with IFT control systems. Includes: On/Off Wall Switch, USB-C Port, Battery Backup, Cover Plate, 12' Wire Harness	HTI 1	\$	179	Y	14	14	14	Y
IntelliFire app									
IFT-WFM	IntelliFire Wi-Fi Module that works with the IntelliFire iOS and Android app. Use to control all the features of your fireplace via a smart device. An RC400, RC450 or RC150 is required for thermostat control	HTI 1	\$	219	Y	Y	Y	Y	Y
Remote/Wall Switch/Wall Thermostat									
IFT-RC150	IntelliFire Touch white wireless wall switch (on/off, cold climate, battery strength indicator)	HTI 1	\$	116	Y	14	14	Y	Y
Touch Screen Remote									
IFT-RC400	IntelliFire Touch black remote control, docking station and auxiliary control module (on/off, flame height, thermostat mode, fan control, child lock, cold climate, timer mode, hot indicator, lights, on-screen maintenance and troubleshooting notifications)	HTI 1	\$	379	Y	Y	Y	Y	Y



Battery Back Up



IntelliFire app

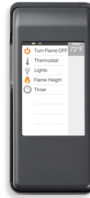

Touch Screen Remote

Venting

Brick Extension Kit

HEAT-OUT-BEK	Exterior Heat-Zone brick extension kit	HTI 1	\$	71	8	21	21	14	Y
--------------	----------------------------------------	-------	----	----	---	----	----	----	---

Venting Notes

Requires 8" DVP pipe. Must have 18" minimum vertical before attaching a 90 degree elbow to the unit. See venting section of manual.

Approved for use with PVLP-SLP, PVI-SLP-B and PVV-SLP with power vent wire harness (order separately) and IFT-RC400 remote. See venting section of manual.

Echelon II 60

Includes:

- 28,000 - 50,000 Btu/Hour Input (NG)
- 20,000 - 37,500 Btu/Hour Input (LP)
- Clear LED dimmable lights
- RC400 remote control
- Battery backup
- Ceramic glass
- Standard with bronze glass media
- IntelliFire Touch ignition system
- If changing media, follow required number of bags below:
 - -- > Crushed Glass: 6 bags of glass
 - -- > Natural stones: 3 bags of stone
 - -- > Log set & stones: 1 bag of stone



Required to Complete - Sold Separately: • Front

		Disc. Code	MSRP USD	004 IA	010 PA	014 CA	016 NC	EXP
ECHEL60IN-C	Echelon II 60" top direct vent fireplace with IntelliFire Touch Ignition System (NG)	MAJ 1	\$ 8,069	Y	14	Y	Y	N

Fronts - Non-Operable (Required to Complete)

Clean Face Trim

CFT-60-BK-C	Clean face trim - Black	HTI 1	\$ 779	Y	Y	Y	Y	Y
CFT-60-BZ-C	Clean face trim - Bronze	HTI 1	\$ 819	14	14	14	14	Y
CFT-60-PT-C	Clean face trim - Pewter	MAJ 1	\$ 819	14	14	14	14	Y

Picture Frame Front

PFF-60-CH-C	Picture frame front - Charcoal	MAJ 1	\$ 959	14	14	14	14	Y
-------------	--------------------------------	-------	--------	----	----	----	----	---



Clean Face Trim



Picture Frame Front

Conversion Kit

Conversion Kits

LPK-ECHEL60	CONVERSION KIT, LP	MAJ 1	\$ 99	28	21	14	14	Y
-------------	--------------------	-------	-------	----	----	----	----	---

Gas Logs - Log Set Option

Driftwood Log Set

LOGS-DRTWOOD-60	Driftwood log set	MAJ 1	\$ 639	Y	14	14	14	Y
-----------------	-------------------	-------	--------	---	----	----	----	---

Media

Media

GLASS-DM	Glass, Diamond (1 bag)	MAJ 1	\$ 71	Y	Y	14	Y	Y
GLASS-BZ	Glass, Bronze (1 bag)	MAJ 1	\$ 71	Y	21	14	14	Y
GLASS-SP	Glass, Sapphire (1 bag)	MAJ 1	\$ 71	Y	Y	14	14	Y
GLASS-OY	Glass, Onyx (1 bag)	MAJ 1	\$ 71	Y	Y	14	Y	Y

Stones										
STONES-NATURAL	Natural stones (1 bag)	HTI 1	\$	111	Y	Y	Y	Y	Y	Y
Liner Kit										
Black Glass Liner Kit - 60										
BGK-60	Reflective black ceramic glass liner kit	HTI 1	\$	849	Y	14	14	Y	Y	Y
Heat Management										
Heat Management										
PH-FRT	Passive Heat kit for front or top discharge	HTI 1	\$	169	Y	Y	Y	Y	Y	Y
PH-SIDE	Passive Heat kit for side discharge (includes 2 side registers)	HTI 1	\$	239	Y	Y	Y	Y	Y	Y
PHTRIM-60C	Vent trim for front discharge (Requires PH-FRT Passive Heat Kit)	HTI 1	\$	239	Y	Y	Y	14	Y	Y
Heat Management - Ducted										
PHTRIM-MCE-60	Ducted vent trim for front discharge using ducted Passive Heat (PHFR-MCE-60)	HTI 1	\$	259	14	14	14	14	N	Y
PHFR-MCE-60	Ducted Passive Heat kit for front discharge (requires PHTRIM-MCE-60 front trim)	HTI 1	\$	739	Y	Y	14	14	Y	Y
Heat Out Kit										
HEAT-OUT-GAS	Heat out kit (includes termination cap, 25' of 6" round duct, fireplace adapter, damper, wall switch and 350CFM fan at termination)	HTI 1	\$	1,489	Y	14	Y	14	Y	Y
Heat Zone Kit										
HZLIN-ADP	Heat Zone adaptor, must order for using HEAT-ZONE-GAS	HTI 1	\$	169	Y	Y	Y	14	Y	Y
HEAT-ZONE-GAS	Heat-Zone Kit includes fan, 20' of 6" round duct, vent, wall adapter & on/off control. Wire Plug Assembly 26D0619 required if controlling w/RC400 remote. Used in IFT units with ACM & not a GFK fan. Compatible for up to 2 HEAT-ZONE-GAS kits. See manual.	HTI 1	\$	549	Y	Y	Y	Y	Y	Y
Control, remotes, wall switches										
Battery Back Up										
BATTERY-WSK	Battery backup wall switch kit for units with IFT control systems. Includes: On/Off Wall Switch, USB-C Port, Battery Backup, Cover Plate, 12' Wire Harness	HTI 1	\$	179	Y	14	14	14	Y	Y
IntelliFire app										
IFT-WFM	IntelliFire Wi-Fi Module that works with the IntelliFire iOS and Android app. Use to control all the features of your fireplace via a smart device. An RC400, RC450 or RC150 is required for thermostat control	HTI 1	\$	219	Y	Y	Y	Y	Y	Y
Remote/Wall Switch/Wall Thermostat										
IFT-RC150	IntelliFire Touch white wireless wall switch (on/off, cold climate, battery strength indicator)	HTI 1	\$	116	Y	14	14	Y	Y	Y
Touch Screen Remote										
IFT-RC400	IntelliFire Touch black remote control, docking station and auxiliary control module (on/off, flame height, thermostat mode, fan control, child lock, cold climate, timer mode, hot indicator, lights, on-screen maintenance and troubleshooting notifications)	HTI 1	\$	379	Y	Y	Y	Y	Y	Y



Battery Back Up



IntelliFire app

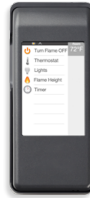

Touch Screen Remote

Venting

Brick Extension Kit

HEAT-OUT-BEK	Exterior Heat-Zone brick extension kit	HTI 1	\$	71	8	21	21	14	Y
--------------	----------------------------------------	-------	----	----	---	----	----	----	---

Venting Notes

Requires 8" DVP pipe. Must have 18" minimum vertical before attaching a 90 degree elbow to unit. See venting section of manual.

Approved for use with PVLP-SLP, PVI-SLP-B and PVV-SLP with power vent wire harness (order separately) and IFT-RC400 remote. See venting section of manual.

Echelon II 72

Includes:

- 30,000 - 58,000 Btu/Hour Input (NG)
- 25,000 - 45,000 Btu/Hour Input (LP)
- Clear LED dimmable lights
- RC400 remote control
- Battery backup
- Ceramic glass
- Standard with bronze glass media
- IntelliFire Touch ignition system
- If changing media, follow required number of bags below:
 - -- > Crushed Glass: 7 bags of glass
 - -- > Natural stones: 4 bags of stone
 - -- > Log set & stones: 1 bag of stone



Required to Complete - Sold Separately: • Front

		Disc. Code	MSRP USD	004 IA	010 PA	014 CA	016 NC	EXP
ECHEL72IN-C	Echelon II 72" top direct vent fireplace with IntelliFire Touch Ignition System (NG)	MAJ 1	\$ 10,599	Y	14	14	14	N

Fronts - Non-Operable (Required to Complete)

Clean Face Trim

CFT-72-BK-C	Clean face trim - Black	HTI 1	\$ 829	Y	Y	Y	Y	Y
CFT-72-BZ-C	Clean face trim - Bronze	HTI 1	\$ 889	14	14	14	14	Y
CFT-72-PT-C	Clean face trim - Pewter	HTI 1	\$ 889	14	14	14	14	Y



Clean Face Trim

Conversion Kit

Conversion Kits

LPK-ECHEL72	CONVERSION KIT, LP	MAJ 1	\$ 99		21	14	14	Y
-------------	--------------------	-------	-------	--	----	----	----	---

Gas Logs - Log Set Option

Driftwood Log Set

LOGS-DRTWOOD-72	Driftwood log set	MAJ 1	\$ 759	Y	14	14	14	Y
-----------------	-------------------	-------	--------	---	----	----	----	---

Media

Media

GLASS-DM	Glass, Diamond (1 bag)	MAJ 1	\$ 71	Y	Y	14	Y	Y
GLASS-OY	Glass, Onyx (1 bag)	MAJ 1	\$ 71	Y	Y	14	Y	Y
GLASS-SP	Glass, Sapphire (1 bag)	MAJ 1	\$ 71	Y	Y	14	14	Y
GLASS-BZ	Glass, Bronze (1 bag)	MAJ 1	\$ 71	Y	21	14	14	Y

Stones

STONES-NATURAL	Natural stones (1 bag)	HTI 1	\$ 111	Y	Y	Y	Y	Y
----------------	------------------------	-------	--------	---	---	---	---	---

Liner Kit

Black Glass Liner Kit - 72

BGK-72	Reflective black ceramic glass liner kit	HTI 1	\$ 999	14	21	14	14	Y
--------	------------------------------------------	-------	--------	----	----	----	----	---

Heat Management					
Heat Management					
PH-FRT	Passive Heat kit for front or top discharge	HTI 1	\$ 169	Y	Y
PHTRIM-72C	Vent trim for front discharge (Requires PH-FRT Passive Heat Kit)	HTI 1	\$ 239	Y	14
PH-SIDE	Passive Heat kit for side discharge (includes 2 side registers)	HTI 1	\$ 239	Y	Y
Heat Management - Ducted					
PHTRIM-MCE-72	Ducted vent trim for front discharge using ducted Passive Heat (PHFR-MCE-72)	HTI 1	\$ 279	14	14
PHFR-MCE-72	Ducted Passive Heat kit for front discharge (requires PHTRIM-MCE-72 front trim)	HTI 1	\$ 789	14	14
Heat Out Kit					
HEAT-OUT-GAS	Heat out kit (includes termination cap, 25' of 6" round duct, fireplace adapter, damper, wall switch and 350CFM fan at termination)	HTI 1	\$ 1,489	Y	14
Heat Zone Kit					
HZLIN-ADP	Heat Zone adaptor, must order for using HEAT-ZONE-GAS	HTI 1	\$ 169	Y	Y
HEAT-ZONE-GAS	Heat-Zone Kit includes fan, 20' of 6" round duct, vent, wall adapter & on/off control. Wire Plug Assembly 26D0619 required if controlling w/RC400 remote. Used in IFT units with ACM & not a GFK fan. Compatible for up to 2 HEAT-ZONE-GAS kits. See manual.	HTI 1	\$ 549	Y	Y
Control, remotes, wall switches					
Battery Back Up					
BATTERY-WSK	Battery backup wall switch kit for units with IFT control systems. Includes: On/Off Wall Switch, USB-C Port, Battery Backup, Cover Plate, 12' Wire Harness	HTI 1	\$ 179	Y	14
IntelliFire app					
IFT-WFM	IntelliFire Wi-Fi Module that works with the IntelliFire iOS and Android app. Use to control all the features of your fireplace via a smart device. An RC400, RC450 or RC150 is required for thermostat control	HTI 1	\$ 219	Y	Y
Remote/Wall Switch/Wall Thermostat					
IFT-RC150	IntelliFire Touch white wireless wall switch (on/off, cold climate, battery strength indicator)	HTI 1	\$ 116	Y	14
Touch Screen Remote					
IFT-RC400	IntelliFire Touch black remote control, docking station and auxiliary control module (on/off, flame height, thermostat mode, fan control, child lock, cold climate, timer mode, hot indicator, lights, on-screen maintenance and troubleshooting notifications)	HTI 1	\$ 379	Y	Y



Battery Back Up



IntelliFire app

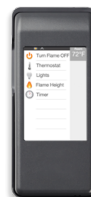

Touch Screen Remote

Venting

Brick Extension Kit

HEAT-OUT-BEK	Exterior Heat-Zone brick extension kit	HTI 1	\$	71	8	21	21	14	Y
--------------	----------------------------------------	-------	----	----	---	----	----	----	---

Venting Notes

Requires 8" DVP pipe. Must have a 30" minimum vertical before attaching a 90 degree elbow to unit. See venting section of manual.

Approved for use with PVLP-SLP, PVI-SLP-B and PVV-SLP with power vent wire harness (order separately) and IFT-RC400 remote. See venting section of manual.

Jade 32

Includes:

- 13,250 - 19,000 Btu/Hour Input (NG)
- 12,750 - 16,500 Btu/Hour Input (LP)
- IntelliFire Touch ignition system
- Bronze glass media
- Tempered glass
- Junction box & Battery backup
- Manual gas valve shut-off and flex connector
- 4" x 6-5/8" top vent collar
- If installing a Passive Heat Kit you cannot use a fan
- If ordering lights or fan, must order IFT-RC400
- If changing media, follow required number of bags below:
 - Glass media: 2 bags of glass
 - Natural stones: 4 bags of stones
 - Log set & stones: 1/2 bag of stones



Required to Complete - Sold Separately: • Front

		Disc. Code	MSRP USD	004 IA	010 PA	014 CA	016 NC	EXP
JADE32IN-B	Jade 32" direct vent gas fireplace with IntelliFire Touch ignition system (NG)	MAJ 1	\$ 2,639	14	14	14	14	N

Fronts - Non-Operable (Required to Complete)

Clean Face Trim

CFTF-32-BK	Clean Face Trim - Black	HTI 1	\$ 429	14	Y	Y	Y	Y
------------	-------------------------	-------	--------	----	---	---	---	---

Picture Frame Front

PFF-32-CH	Picture frame front - Charcoal	MAJ 1	\$ 739	14	14	14	14	Y
-----------	--------------------------------	-------	--------	----	----	----	----	---



Clean Face Trim



Picture Frame Front

Conversion Kit

Conversion Kit

LPK-32LINEAR	LP conversion kit	HTI 1	\$ 99	Y	Y	Y	Y	Y
--------------	-------------------	-------	-------	---	---	---	---	---

Gas Logs - Log Set Option

Driftwood Log Set

DRTWOOD-JADE	Driftwood log set	MAJ 1	\$ 469	Y	14	14	14	Y
--------------	-------------------	-------	--------	---	----	----	----	---

Media

Media

GLASS-OY	Glass, Onyx (1 bag)	MAJ 1	\$ 71	Y	Y	14	Y	Y
GLASS-SP	Glass, Sapphire (1 bag)	MAJ 1	\$ 71	Y	Y	14	14	Y
GLASS-BZ	Glass, Bronze (1 bag)	MAJ 1	\$ 71	Y	21	14	14	Y
GLASS-DM	Glass, Diamond (1 bag)	MAJ 1	\$ 71	Y	Y	14	Y	Y

Stones									
STONES-NATURAL	Natural stones (1 bag)	HTI 1	\$	111	Y	Y	Y	Y	Y
Lighting									
LED Accent Light									
LED-LINEAR	LED accent lights (must order LED-SWITCH for multi-color selection)	HTI 1	\$	369	Y	Y	Y	Y	Y
Refractory									
Glass Refractory									
GLASS-32LINEAR	Fade-resistant reflective black glass interior panels	HTI 1	\$	569	14	21	14	14	Y
Fans									
Fan									
GFK-160C	Fan kit 160 CFM (fan only)	HTI 1	\$	259	Y	Y	Y	Y	Y
Heat Management									
Heat Management									
PH-SIDETRIM	Passive Heat trim kit for side discharge (includes 2 side registers)(Starting collars sold separately)	HTI 1	\$	108	Y	Y	Y	Y	Y
PH-FRTTRIM-32	Passive Heat Vent Trim Kit For Front Discharge (32")(Starting collars sold separately)	HTI 1	\$	146	14	14	14	14	Y
PH-LINEAR	Starting Collars for Non-Ducted Passive Heat (Required when using passive heat - For use with Front, Side, Top Discharges)	HTI 1	\$	189	Y	Y	Y	Y	Y
Heat Out Kit									
HEAT-OUT-GAS	Heat out kit (includes termination cap, 25' of 6" round duct, fireplace adapter, damper, wall switch and 350CFM fan at termination)	HTI 1	\$	1,489	Y	14	Y	14	Y
Heat Zone Kit									
HEAT-ZONE-GAS	Heat-Zone Kit includes fan, 20' of 6" round duct, vent, wall adapter & on/off control. Wire Plug Assembly 26D0619 required if controlling w/RC400 remote. Used in IFT units with ACM & not a GFK fan. Compatible for up to 2 HEAT-ZONE-GAS kits. See manual.	HTI 1	\$	549	Y	Y	Y	Y	Y
Control, remotes, wall switches									
Battery Back Up									
BATTERY-WSK	Battery backup wall switch kit for units with IFT control systems. Includes: On/Off Wall Switch, USB-C Port, Battery Backup, Cover Plate, 12' Wire Harness	HTI 1	\$	179	Y	14	14	14	Y
IntelliFire app									
IFT-WFM	IntelliFire Wi-Fi Module that works with the IntelliFire iOS and Android app. Use to control all the features of your fireplace via a smart device. An RC400, RC450 or RC150 is required for thermostat control	HTI 1	\$	219	Y	Y	Y	Y	Y
IntelliFire Touch Controls - Aux Module									
IFT-ACM	IntelliFire Touch AUX Module. Must order if adding Fan, Lights or Power Vent and want to use the IFT-WFM. Do not need to order if using IFT-RC400 (includes IFT-ACM).	HTI 1	\$	96	14	Y	14	14	Y
Remote/Wall Switch/Wall Thermostat									
IFT-RC150	IntelliFire Touch white wireless wall switch (on/off, cold climate, battery strength indicator)	HTI 1	\$	116	Y	14	14	Y	Y
LED-SWITCH	3 toggle wall switch for multi-color selection	HTI 1	\$	136	Y	Y	14	14	Y

Touch Screen Remote

IFT-RC400	IntelliFire Touch black remote control, docking station and auxiliary control module (on/off, flame height, thermostat mode, fan control, child lock, cold climate, timer mode, hot indicator, lights, on-screen maintenance and troubleshooting notifications)	HTI 1	\$ 379	Y	Y	Y	Y	Y
-----------	-----------------------------------------------------------------------------------------------------------------------------------------------------------------------------------------------------------------------------------------------------------------	-------	--------	---	---	---	---	---



Battery Back Up



IntelliFire app

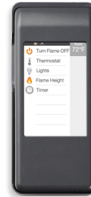

Touch Screen Remote

Venting

Brick Extension Kit

HEAT-OUT-BEK	Exterior Heat-Zone brick extension kit	HTI 1	\$ 71	8	21	21	14	Y
--------------	----------------------------------------	-------	-------	---	----	----	----	---

Venting Notes

Requires 6-5/8" SLP pipe. See venting section.

Approved for use with PVLV-SLP, PVI-SLP-B and PVV-SLP with power vent wire harness and IFT-RC400 remote (order separately). See venting section of manual.

Jade 42

Includes:

- 17,500 - 25,250 Btu/Hour Input (NG)
- 17,500 - 25,500 Btu/Hour Input (LP)
- IntelliFire Touch ignition system
- Bronze glass media
- Tempered glass
- Junction box & Battery backup
- Manual gas valve shut-off and flex connector
- 4" x 6-58" top vent collar
- If installing a Passive Heat Kit you cannot use a fan
- If ordering lights or fan, must order IFT-RC400
- If changing media, follow required number of bags below:
 - Glass media: 3 bags of glass
 - Natural stones: 6 bags of stones
 - Log set & stones: 1 bag of stones



Required to Complete - Sold Separately: • Front

		Disc. Code	MSRP USD	004 IA	010 PA	014 CA	016 NC	EXP
JADE42IL-B	Jade 42" direct vent gas fireplace with IntelliFire Touch ignition system (LP)	MAJ 1	\$ 3,249	Y	14	14	14	N
JADE42IN-B	Jade 42" direct vent gas fireplace with IntelliFire Touch ignition system (NG)	MAJ 1	\$ 3,249	Y	Y	Y	Y	N

Fronts - Non-Operable (Required to Complete)

Clean Face Trim

CFTF-42-BK	Clean Face Trim - Black	HTI 1	\$ 459	Y	Y	Y	Y	Y
CFTF-42-PT	Clean Face Trim - Pewter	MAJ 1	\$ 499	14	14	14	14	Y
CFTF-42-BZ	Clean Face Trim - Bronze	HTI 1	\$ 499	14	14	Y	14	Y

Picture Frame Front

PFF-42-CH	Picture frame front - Charcoal	MAJ 1	\$ 759	14	14	14	14	Y
-----------	--------------------------------	-------	--------	----	----	----	----	---



Clean Face Trim



Picture Frame Front

Gas Logs - Log Set Option

Driftwood Log Set

DRTWOOD-JADE	Driftwood log set	MAJ 1	\$ 469	Y	14	14	14	Y
--------------	-------------------	-------	--------	---	----	----	----	---

Media

Media

GLASS-SP	Glass, Sapphire (1 bag)	MAJ 1	\$ 71	Y	Y	14	14	Y
GLASS-BZ	Glass, Bronze (1 bag)	MAJ 1	\$ 71	Y	21	14	14	Y
GLASS-DM	Glass, Diamond (1 bag)	MAJ 1	\$ 71	Y	Y	14	Y	Y
GLASS-OY	Glass, Onyx (1 bag)	MAJ 1	\$ 71	Y	Y	14	Y	Y

Stones								
STONES-NATURAL	Natural stones (1 bag)	HTI 1	\$ 111	Y	Y	Y	Y	Y
Lighting								
LED Accent Light								
LED-LINEAR	LED accent lights (must order LED-SWITCH for multi-color selection)	HTI 1	\$ 369	Y	Y	Y	Y	Y
Refractory								
Glass Refractory								
GLASS-42LINEAR	Fade-resistant reflective black glass interior panels	HTI 1	\$ 609	Y	Y	Y	Y	Y
Fans								
Fan								
GFK-160C	Fan kit 160 CFM (fan only)	HTI 1	\$ 259	Y	Y	Y	Y	Y
Heat Management								
Heat Management								
PH-SIDETRIM	Passive Heat trim kit for side discharge (includes 2 side registers)(Starting collars sold separately)	HTI 1	\$ 108	Y	Y	Y	Y	Y
PH-LINEAR	Starting Collars for Non-Ducted Passive Heat (Required when using passive heat - For use with Front, Side, Top Discharges)	HTI 1	\$ 189	Y	Y	Y	Y	Y
PH-FRTTRIM-42	Passive Heat Vent Trim Kit For Front Discharge (42")(Starting collars sold separately)	HTI 1	\$ 199	Y	Y	Y	Y	Y
Heat Out Kit								
HEAT-OUT-GAS	Heat out kit (includes termination cap, 25' of 6" round duct, fireplace adapter, damper, wall switch and 350CFM fan at termination)	HTI 1	\$ 1,489	Y	14	Y	14	Y
Heat Zone Kit								
HEAT-ZONE-GAS	Heat-Zone Kit includes fan, 20' of 6" round duct, vent, wall adapter & on/off control. Wire Plug Assembly 26D0619 required if controlling w/RC400 remote. Used in IFT units with ACM & not a GFK fan. Compatible for up to 2 HEAT-ZONE-GAS kits. See manual.	HTI 1	\$ 549	Y	Y	Y	Y	Y
Control, remotes, wall switches								
Battery Back Up								
BATTERY-WSK	Battery backup wall switch kit for units with IFT control systems. Includes: On/Off Wall Switch, USB-C Port, Battery Backup, Cover Plate, 12' Wire Harness	HTI 1	\$ 179	Y	14	14	14	Y
IntelliFire app								
IFT-WFM	IntelliFire Wi-Fi Module that works with the IntelliFire iOS and Android app. Use to control all the features of your fireplace via a smart device. An RC400, RC450 or RC150 is required for thermostat control	HTI 1	\$ 219	Y	Y	Y	Y	Y
IntelliFire Touch Controls - Aux Module								
IFT-ACM	IntelliFire Touch AUX Module. Must order if adding Fan, Lights or Power Vent and want to use the IFT-WFM. Do not need to order if using IFT-RC400 (includes IFT-ACM).	HTI 1	\$ 96	14	Y	14	14	Y
Remote/Wall Switch/Wall Thermostat								
IFT-RC150	IntelliFire Touch white wireless wall switch (on/off, cold climate, battery strength indicator)	HTI 1	\$ 116	Y	14	14	Y	Y
LED-SWITCH	3 toggle wall switch for multi-color selection	HTI 1	\$ 136	Y	Y	14	14	Y

Touch Screen Remote

IFT-RC400	IntelliFire Touch black remote control, docking station and auxiliary control module (on/off, flame height, thermostat mode, fan control, child lock, cold climate, timer mode, hot indicator, lights, on-screen maintenance and troubleshooting notifications)	HTI 1	\$ 379	Y	Y	Y	Y	Y
-----------	-----------------------------------------------------------------------------------------------------------------------------------------------------------------------------------------------------------------------------------------------------------------	-------	--------	---	---	---	---	---



Battery Back Up



IntelliFire app

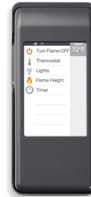

Touch Screen Remote

Venting

Brick Extension Kit

HEAT-OUT-BEK	Exterior Heat-Zone brick extension kit	HTI 1	\$ 71	8	21	21	14	Y
--------------	----------------------------------------	-------	-------	---	----	----	----	---

Venting Notes

Requires 6-5/8" SLP pipe. Must have a 12" minimum vertical vent before attaching a 90° elbow to unit. See venting section.

Approved for use with PVLV-SLP, PVI-SLP-B and PVV-SLP with power vent wire harness and IFT-RC400 remote (order separately). See venting section of manual.

Marquis II 36 IFT

Includes:

- 25,000 - 44,000 Btu/Hour Input (NG)
- 24,000 - 43,500 Btu/Hour Input (LP)
- RC400 touchscreen remote
- LED ember bed lighting
- LED accent lighting
- ClearView ceramic glass
- 7 ceramic fiber split logs
- Gas flex connector
- Junction box
- IntelliFire Touch ignition



Required to Complete - Sold Separately: • Front • Refractory

		Disc. Code	MSRP USD	004 IA	010 PA	014 CA	016 NC	EXP
MARQ36IN-B	Marquis II 36" top, direct vent fireplace with IntelliFire Touch ignition (NG)	MAJ 1	\$ 5,759	14	14	14	14	N

Fronts - Non-Operable (Required to Complete)

Firescreens

FSMQ36CH	Firescreen Front, 36" - Charcoal	MAJ 1	\$ 669	14	14	14	14	Y
FSMQ36BZ	Firescreen Front, 36" - Bronze	MAJ 1	\$ 729	14	14	14	14	Y
FSMQ36PT	Firescreen Front, 36" - Pewter	MAJ 1	\$ 729	14	14	14	21	Y

Refractory (Required to Complete)

Refractory

2614-053	Hearthbrick and top for 36" Black Glass walls (must order GLMQ36 Reflective Black Glass walls as well)	MAJ 1	\$ 369	Y	28	28	28	N
BRICKMQ36TB-B	Brick interior panels Marq36 - Tavern Brown	MAJ 1	\$ 779	Y	14	14	14	N
BRICKMQ36HB-B	Brick interior panels Marq36 - Tavern Brown herringbone	MAJ 1	\$ 799	Y	70	70	42	N
GLMQ36	Reflective black glass walls for 36" (must order 36" hearthbrick and top as well)	HTI 1	\$ 1,019	14	21	14	14	N

Conversion Kit

Conversion Kits

LPKMARQ36	LP conversion kit	MAJ 1	\$ 99		21	14	14	Y
-----------	-------------------	-------	-------	--	----	----	----	---

Heat Management

Heat Out Kit

HEAT-OUT-GAS	Heat out kit (includes termination cap, 25' of 6" round duct, fireplace adapter, damper, wall switch and 350CFM fan at termination)	HTI 1	\$ 1,489	Y	14	Y	14	Y
--------------	-------------------------------------------------------------------------------------------------------------------------------------	-------	----------	---	----	---	----	---

Heat Zone Kit

HEAT-ZONE-GAS	Heat-Zone Kit includes fan, 20' of 6" round duct, vent, wall adapter & on/off control. Wire Plug Assembly 26D0619 required if controlling w/RC400 remote. Used in IFT units with ACM & not a GFK fan. Compatible for up to 2 HEAT-ZONE-GAS kits. See manual.	HTI 1	\$ 549	Y	Y	Y	Y	Y
---------------	--------------------------------------------------------------------------------------------------------------------------------------------------------------------------------------------------------------------------------------------------------------	-------	--------	---	---	---	---	---

Control, remotes, wall switches

Battery Back Up

BATTERY-WSK	Battery backup wall switch kit for units with IFT control systems. Includes: On/Off Wall Switch, USB-C Port, Battery Backup, Cover Plate, 12' Wire Harness	HTI 1	\$ 179	Y	14	14	14	Y
-------------	------------------------------------------------------------------------------------------------------------------------------------------------------------	-------	--------	---	----	----	----	---

IntelliFire app					
IFT-WFM	IntelliFire Wi-Fi Module that works with the IntelliFire iOS and Android app. Use to control all the features of your fireplace via a smart device. An RC400, RC450 or RC150 is required for thermostat control	HTI 1	\$ 219	Y	Y

Remote/Wall Switch/Wall Thermostat					
IFT-RC150	IntelliFire Touch white wireless wall switch (on/off, cold climate, battery strength indicator)	HTI 1	\$ 116	Y	14

Touch Screen Remote					
IFT-RC400	IntelliFire Touch black remote control, docking station and auxiliary control module (on/off, flame height, thermostat mode, fan control, child lock, cold climate, timer mode, hot indicator, lights, on-screen maintenance and troubleshooting notifications)	HTI 1	\$ 379	Y	Y



Battery Back Up



IntelliFire app

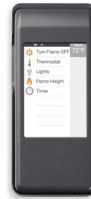

Touch Screen Remote

Venting

Brick Extension Kit

HEAT-OUT-BEK	Exterior Heat-Zone brick extension kit	HTI 1	\$ 71	8	21	21	14	Y
--------------	----------------------------------------	-------	-------	---	----	----	----	---

Venting Notes

Requires 8" DVP pipe. Must have a 24" minimum vertical vent before attaching a 90° elbow to unit. See Venting section.
 Approved for use with PVL P-SLP, PVI-SLP-B and PVV-SLP with power vent wire harness (order separately). See venting section of manual.

Marquis II 42 IFT

Includes:

- 30,000 - 54,500 Btu/Hour Input (NG)
- 23,500 - 47,500 Btu/Hour Input (LP)
- RC400 touchscreen remote
- LED ember bed lighting
- LED accent lighting
- ClearView ceramic glass
- 7 ceramic fiber split logs
- Gas flex connector
- Junction box
- IntelliFire Touch ignition



Required to Complete - Sold Separately: • Front • Refractory

		Disc. Code	MSRP USD	004 IA	010 PA	014 CA	016 NC	EXP
MARQ42IN-B	Marquis II 42" top, direct vent fireplace with IntelliFire Touch ignition (NG)	MAJ 1	\$ 6,379	Y	14	21	Y	N

Fronts - Non-Operable (Required to Complete)

Firescreens

FSMQ42CH	Firescreen Front, 42" - Charcoal	MAJ 1	\$ 739	14	14	14	14	Y
FSMQ42BZ	Firescreen front 42" - Bronze	MAJ 1	\$ 779	14	14	14	14	Y
FSMQ42PT	Firescreen Front, 42" - Pewter	MAJ 1	\$ 779	14	14	14	21	Y

Refractory (Required to Complete)

Refractory

2615-053	Hearthbrick and top for 42" Black Glass walls (must order GLMQ42 Reflective Black Glass walls as well)	MAJ 1	\$ 369	Y	42	42	49	N
BRICKMQ42TB-B	Brick interior panels Marq42 - Tavern Brown	MAJ 1	\$ 829	Y	35	35	21	N
BRICKMQ42HB-B	Brick interior panels Marq42 - Tavern Brown herringbone	MAJ 1	\$ 849	Y	35	35	42	N
GLMQ42	Reflective black glass walls for 42" (must order 42" hearthbrick and top as well)	HTI 1	\$ 1,179	14	14	14	14	Y

Conversion Kit

Conversion Kits

LPKMARQ42	LP conversion kit	MAJ 1	\$ 99		21	14	14	Y
-----------	-------------------	-------	-------	--	----	----	----	---

Heat Management

Heat Out Kit

HEAT-OUT-GAS	Heat out kit (includes termination cap, 25' of 6" round duct, fireplace adapter, damper, wall switch and 350CFM fan at termination)	HTI 1	\$ 1,489	Y	14	Y	14	Y
--------------	-------------------------------------------------------------------------------------------------------------------------------------	-------	----------	---	----	---	----	---

Heat Zone Kit

HEAT-ZONE-GAS	Heat-Zone Kit includes fan, 20' of 6" round duct, vent, wall adapter & on/off control. Wire Plug Assembly 26D0619 required if controlling w/RC400 remote. Used in IFT units with ACM & not a GFK fan. Compatible for up to 2 HEAT-ZONE-GAS kits. See manual.	HTI 1	\$ 549	Y	Y	Y	Y	Y
---------------	--------------------------------------------------------------------------------------------------------------------------------------------------------------------------------------------------------------------------------------------------------------	-------	--------	---	---	---	---	---

Control, remotes, wall switches

Battery Back Up

BATTERY-WSK	Battery backup wall switch kit for units with IFT control systems. Includes: On/Off Wall Switch, USB-C Port, Battery Backup, Cover Plate, 12' Wire Harness	HTI 1	\$ 179	Y	14	14	14	Y
-------------	------------------------------------------------------------------------------------------------------------------------------------------------------------	-------	--------	---	----	----	----	---

IntelliFire app					
IFT-WFM	IntelliFire Wi-Fi Module that works with the IntelliFire iOS and Android app. Use to control all the features of your fireplace via a smart device. An RC400, RC450 or RC150 is required for thermostat control	HTI 1	\$ 219	Y	Y
Remote/Wall Switch/Wall Thermostat					
IFT-RC150	IntelliFire Touch white wireless wall switch (on/off, cold climate, battery strength indicator)	HTI 1	\$ 116	Y	Y
Touch Screen Remote					
IFT-RC400	IntelliFire Touch black remote control, docking station and auxiliary control module (on/off, flame height, thermostat mode, fan control, child lock, cold climate, timer mode, hot indicator, lights, on-screen maintenance and troubleshooting notifications)	HTI 1	\$ 379	Y	Y



Battery Back Up



IntelliFire app

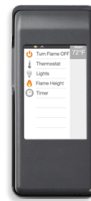

Touch Screen Remote

Venting					
Brick Extension Kit					
HEAT-OUT-BEK	Exterior Heat-Zone brick extension kit	HTI 1	\$ 71	8	21

Venting Notes					
Requires 8" DVP pipe. Must have a 24" minimum vertical vent before attaching a 90° elbow to unit (36" for LP). See Venting section.					
Approved for use with PVL P-SLP, PVI-SLP-B and PVV-SLP with power vent wire harness (order separately). See venting section of manual.					

Mercury 32

Includes:

- 13,500 - 19,100 Btu/Hour Input (NG)
- 14,500 - 19,100 Btu/Hour Input (LP)
- 5" x 8" rear vent collar
- 4" x 6 5/8" top vent collar
- 6 ceramic fiber logs
- Full firescreen front and hood
- Gas flex connector
- Glowing embers
- Battery backup
- Junction box
- 12' control wire
- Tempered glass



No additional items required to complete.

		Disc.	MSRP	004	010	014	016	EXP
		Code	USD	IA	PA	CA	NC	
MERC32IN	Mercury 32" Direct Vent Gas Fireplace, top/rear vent with Intellifire (NG)	MAJ 1	\$ 2,039	Y	Y	Y	Y	N

Fans

Fan								
GFK-160C	Fan kit 160 CFM (fan only)	HTI 1	\$ 259	Y	Y	Y	Y	Y
GFK-160A	Fan kit 160 CFM (includes rheostat and temperature sensor)	HTI 1	\$ 319	Y	Y	Y	Y	Y

Trim Kits

Trim Kit 550								
550-TRIM3-BK-B	Trim Kit, 3 Sided - Black (not for use with Clean Face Kit)	HTI 1	\$ 299	Y	Y	Y	14	Y
550-TRIM4-BK-B	Trim Kit, 4 Sided - Black (not for use with Clean Face Kit)	HTI 1	\$ 359	Y	14	Y	14	Y

Control, remotes, wall switches

Remote/Wall Switch/Wall Thermostat								
RCT-MLT-HHT	IPI Remote Control (on/off, fan speed, flame control, temperature readout, thermostat mode, timer mode)	HTI 1	\$ 399	Y	Y	Y	Y	Y

Smart Stat Remote Control

SMART-STAT-HHT	Remote Control - IPI or SP (on/off, temp readout, thermostat mode, timer mode)	HTI 1	\$ 289	Y	Y	Y	Y	Y
----------------	--------------------------------------------------------------------------------	-------	--------	---	---	---	---	---

Wall Switch

WSK-21-W	Wall switch kit- White (includes 20 ft of wire)	HTI 1	\$ 40	Y	Y	Y	Y	Y
----------	-------------------------------------------------	-------	-------	---	---	---	---	---

Venting Notes

Requires SLP series or SLP-Flex series pipe when venting off top of unit. See Venting section.

Requires DVP series pipe when venting off rear of unit. See Venting section.

Meridian 36

Includes:

- 16,000 - 30,000 Btu/Hour Input (NG)
- 17,000 - 28,000 Btu/Hour Input (LP)
- 12 ft Wall switch wire
- Tempered glass
- 6 ceramic fiber logs
- Glowing embers
- Battery backup
- IntelliFire Touch Ignition System
- Note: Flame adjustment requires RC400 or IFT-WFM



Required to Complete - Sold Separately: • Front

		Disc. Code	MSRP USD	004 IA	010 PA	014 CA	016 NC	EXP
MER36N	Meridian 36" top/rear direct vent fireplace with Intellifire Touch ignition (NG)	MAJ 1	\$ 2,999	Y	Y	14	Y	N
MER36L	Meridian 36" top/rear direct vent fireplace with IntelliFire Touch ignition (LP)	MAJ 1	\$ 2,999	14	14	21	21	N

Fronts (Required to Complete)

Essence

ESSENCE36BK	Essence inside fit front - Black	MAJ 1	\$ 359	Y	Y	14	Y	Y
-------------	----------------------------------	-------	--------	---	---	----	---	---

Ventura

VENTURA36BK	Ventura overlap front - Black	MAJ 1	\$ 619	Y	14	14	14	Y
VENTURA36NB	Ventura overlap front - New Bronze	MAJ 1	\$ 669	14	14	14	14	Y

Manor

MANOR36BK	Manor arched overlap fit front with ClearVue mesh - Black	MAJ 1	\$ 1,019	Y	Y	14	14	Y
MANOR36NB	Manor arched overlap fit front with ClearVue mesh - New Bronze	MAJ 1	\$ 1,069	14	14	14	14	Y

Ensemble

ENSEMBLE36GM	Ensemble overlap front with ClearVue mesh and Gun Metal trim	MAJ 1	\$ 1,329	14	14	14	14	Y
ENSEMBLE36NB	Ensemble overlap front with ClearVue mesh and New Bronze trim	MAJ 1	\$ 1,379	Y	14	14	14	Y



Essence



Ventura



Manor

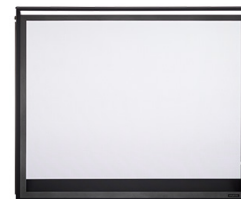

Ensemble

Liner Kit

Brick Refractory

BRICK36MTB	Brick interior panels - Traditional - Tavern Brown	MAJ 1	\$ 359	Y	14	14	14	Y
BRICK36MTBH	Bick interior panels - Herringbone - Tavern Brown	MAJ 1	\$ 389	Y	Y	14	14	Y
BRICK36MCS	Brick interior panels - Castle Stone	MAJ 1	\$ 719	Y	14	14	14	Y

Liner Kit Black Glass Liner - 2 Sided

GL-36M	3 Pc - 2-Sided Reflective Black Glass/Matte Glass Liner	HTI 1	\$ 949	14	14	14	14	Y
--------	---------------------------------------------------------	-------	--------	----	----	----	----	---

Fans					
Fan					
GFK-160C	Fan kit 160 CFM (fan only)	HTI 1	\$ 259	Y	Y
GFK-160A	Fan kit 160 CFM (includes rheostat and temperature sensor)	HTI 1	\$ 319	Y	Y
Heat Management					
Heat Management					
PH-SIDETRIM	Passive Heat trim kit for side discharge (includes 2 side registers)(Starting collars sold separately)	HTI 1	\$ 108	Y	Y
PH-FRTRIM-36	Passive Heat Vent Trim Kit For Front Discharge (36")(Starting collars sold separately)	HTI 1	\$ 189	Y	Y
PH-MR	Passive Heat Kit starting collars (requires a side or front trim kit or use open top chase)	HTI 1	\$ 259	Y	Y
Heat Out Kit					
HEAT-OUT-GAS	Heat out kit (includes termination cap, 25' of 6" round duct, fireplace adapter, damper, wall switch and 350CFM fan at termination)	HTI 1	\$ 1,489	Y	14
Heat Zone Kit					
HZMR-ADP	Required adaptor for HEAT-ZONE-GAS when not being paired with Passive Heat	HTI 0	\$ 102	Y	Y
HEAT-ZONE-GAS	Heat-Zone Kit includes fan, 20' of 6" round duct, vent, wall adapter & on/off control. Wire Plug Assembly 26D0619 required if controlling w/RC400 remote. Used in IFT units with ACM & not a GFK fan. Compatible for up to 2 HEAT-ZONE-GAS kits. See manual.	HTI 1	\$ 549	Y	Y
Control, remotes, wall switches					
Battery Back Up					
BATTERY-WSK	Battery backup wall switch kit for units with IFT control systems. Includes: On/Off Wall Switch, USB-C Port, Battery Backup, Cover Plate, 12' Wire Harness	HTI 1	\$ 179	Y	14
IntelliFire app					
IFT-WFM	IntelliFire Wi-Fi Module that works with the IntelliFire iOS and Android app. Use to control all the features of your fireplace via a smart device. An RC400, RC450 or RC150 is required for thermostat control	HTI 1	\$ 219	Y	Y
IntelliFire Touch Controls - Aux Module					
IFT-ACM	IntelliFire Touch AUX Module. Must order if adding Fan, Lights or Power Vent and want to use the IFT-WFM. Do not need to order if using IFT-RC400 (includes IFT-ACM).	HTI 1	\$ 96	14	Y
Remote/Wall Switch/Wall Thermostat					
IFT-RC150	IntelliFire Touch white wireless wall switch (on/off, cold climate, battery strength indicator)	HTI 1	\$ 116	Y	14
Touch Screen Remote					
IFT-RC400	IntelliFire Touch black remote control, docking station and auxiliary control module (on/off, flame height, thermostat mode, fan control, child lock, cold climate, timer mode, hot indicator, lights, on-screen maintenance and troubleshooting notifications)	HTI 1	\$ 379	Y	Y



Battery Back Up



IntelliFire app

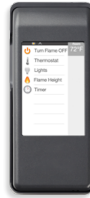

Touch Screen Remote

Venting

Brick Extension Kit

HEAT-OUT-BEK	Exterior Heat-Zone brick extension kit	HTI 1	\$	71	8	21	21	14	Y
--------------	----------------------------------------	-------	----	----	---	----	----	----	---

Venting Notes

Requires 8" DVP pipe.
Approved for use with SLP pipe. Restrictions apply. See Installation manual for venting specifications.
Approved for use with PVLV-SLP, PVI-SLP-B and PVV-SLP with power vent wire harness and IFT-RC400 remote (order separately). See venting section of manual.

Meridian 36 Modern

Includes:

- 17,000 - 34,000 Btu/Hour Input (NG)
- IntelliFire Touch ignition system
- Ceramic glass
- Junction Box
- 2 sided black ceramic glass liner
- STONES-NATURAL: 3 bags (must use with crushed glass media)
- 12 ft wall switch wire
- Note: Flame adjustment requires RC400 or IFT-WFM
- Battery backup
- Please note: LP is not available for this fireplace



Required to Complete - Sold Separately: • Front • Crushed Glass Media (Qty 2)

		Disc. Code	MSRP USD	004 IA	010 PA	014 CA	016 NC	EXP
MER36MN	Meridian 36" Modern top direct vent gas fireplace with Intellifire Touch ignition (NG)	MAJ 1	\$ 3,999	14	14	21	21	N

Fronts (Required to Complete)

Essence

ESSENCE36BK	Essence inside fit front - Black	MAJ 1	\$ 359	Y	Y	14	Y	Y
-------------	----------------------------------	-------	--------	---	---	----	---	---

Ventura

VENTURA36BK	Ventura overlap front - Black	MAJ 1	\$ 619	Y	14	14	14	Y
VENTURA36NB	Ventura overlap front - New Bronze	MAJ 1	\$ 669	14	14	14	14	Y

Manor

MANOR36BK	Manor arched overlap fit front with ClearVue mesh - Black	MAJ 1	\$ 1,019	Y	Y	14	14	Y
MANOR36NB	Manor arched overlap fit front with ClearVue mesh - New Bronze	MAJ 1	\$ 1,069	14	14	14	14	Y

Ensemble

ENSEMBLE36GM	Ensemble overlap front with ClearVue mesh and Gun Metal trim	MAJ 1	\$ 1,329	14	14	14	14	Y
ENSEMBLE36NB	Ensemble overlap front with ClearVue mesh and New Bronze trim	MAJ 1	\$ 1,379	Y	14	14	14	Y



Essence

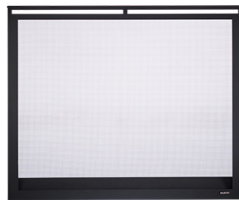

Ventura



Manor



Ensemble

Media (Required to Complete)

Crushed Glass Media

MEDIA-CP	Copper Embers - Crushed Glass Media (1 bag, 5lbs)	HTI 1	\$ 75	Y	Y	Y	Y	Y
MEDIA-CY	Crystal Embers - Crushed Glass Media (1 bag, 5lbs)	HTI 1	\$ 75	Y	Y	Y	Y	Y
MEDIA-GT	Graphite Embers - Crushed Glass Media (1 bag, 5lbs)	HTI 1	\$ 75	Y	Y	Y	Y	Y
MEDIA-SM	Smoked Embers - Crushed Glass Media (1 bag, 5lbs)	HTI 1	\$ 75	Y	Y	Y	Y	Y

Stones								
STONES-NATURAL	Natural stones (1 bag)	HTI 1	\$ 111	Y	Y	Y	Y	Y
Gas Logs - Log Set Option								
Logs								
LOGS-KMOD	Driftwood Logs (must use Crushed Glass Media)	HTI 1	\$ 509	Y	14	14	14	Y
Fans								
Fan								
GFK-160C	Fan kit 160 CFM (fan only)	HTI 1	\$ 259	Y	Y	Y	Y	Y
GFK-160A	Fan kit 160 CFM (includes rheostat and temperature sensor)	HTI 1	\$ 319	Y	Y	Y	Y	Y
Heat Management								
Heat Management								
PH-SIDETRIM	Passive Heat trim kit for side discharge (includes 2 side registers)(Starting collars sold separately)	HTI 1	\$ 108	Y	Y	Y	Y	Y
PH-FRTTRIM-36	Passive Heat Vent Trim Kit For Front Discharge (36")(Starting collars sold separately)	HTI 1	\$ 189	Y	Y	Y	21	Y
PH-MR	Passive Heat Kit starting collars (requires a side or front trim kit or use open top chase)	HTI 1	\$ 259	Y	Y	Y	Y	Y
Heat Out Kit								
HEAT-OUT-GAS	Heat out kit (includes termination cap, 25' of 6" round duct, fireplace adapter, damper, wall switch and 350CFM fan at termination)	HTI 1	\$ 1,489	Y	14	Y	14	Y
Heat Zone Kit								
HZMR-ADP	Required adaptor for HEAT-ZONE-GAS when not being paired with Passive Heat	HTI 0	\$ 102	Y	Y	Y	Y	Y
HEAT-ZONE-GAS	Heat-Zone Kit includes fan, 20' of 6" round duct, vent, wall adapter & on/off control. Wire Plug Assembly 26D0619 required if controlling w/RC400 remote. Used in IFT units with ACM & not a GFK fan. Compatible for up to 2 HEAT-ZONE-GAS kits. See manual.	HTI 1	\$ 549	Y	Y	Y	Y	Y
Control, remotes, wall switches								
IntelliFire app								
IFT-WFM	IntelliFire Wi-Fi Module that works with the IntelliFire iOS and Android app. Use to control all the features of your fireplace via a smart device. An RC400, RC450 or RC150 is required for thermostat control	HTI 1	\$ 219	Y	Y	Y	Y	Y
IntelliFire Touch Controls - Aux Module								
IFT-ACM	IntelliFire Touch AUX Module. Must order if adding Fan, Lights or Power Vent and want to use the IFT-WFM. Do not need to order if using IFT-RC400 (includes IFT-ACM).	HTI 1	\$ 96	14	Y	14	14	Y
Remote/Wall Switch/Wall Thermostat								
IFT-RC150	IntelliFire Touch white wireless wall switch (on/off, cold climate, battery strength indicator)	HTI 1	\$ 116	Y	14	14	Y	Y
Touch Screen Remote								
IFT-RC400	IntelliFire Touch black remote control, docking station and auxiliary control module (on/off, flame height, thermostat mode, fan control, child lock, cold climate, timer mode, hot indicator, lights, on-screen maintenance and troubleshooting notifications)	HTI 1	\$ 379	Y	Y	Y	Y	Y



IntelliFire app

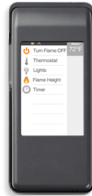

Touch Screen Remote

Venting

Brick Extension Kit

HEAT-OUT-BEK	Exterior Heat-Zone brick extension kit	HTI 1	\$	71	8	21	21	14	Y
--------------	----------------------------------------	-------	----	----	---	----	----	----	---

Venting Notes

Requires 8" DVP pipe. Must have a 6" minimum vertical vent before attaching a 90 degree elbow to the fireplace. See Venting section.

Approved for use with SLP pipe. Restrictions apply. See Installation manual for venting specifications.

Approved for use with PVLV-SLP, PVI-SLP-B and PVV-SLP with power vent wire harness and IFT-RC400 remote (order separately). See venting section of manual.

Meridian 36 Platinum

Includes:

- 22,000 - 40,000 Btu/Hour Input (NG)
- 21,000 - 40,000 Btu/Hour Input (LP)
- Ceramic glass
- 6 Ceramic fiber logs
- LED Accent lighting (not used with Black glass liner)
- GFK-160 variable speed fan
- LED illuminated embers
- Gas flex connector
- RC-400 Touchscreen remote control
- IntelliFire Touch Ignition System
- Battery backup



Required to Complete - Sold Separately: • Front • Liner Kit

		Disc. Code	MSRP USD	004 IA	010 PA	014 CA	016 NC	EXP
MER36PN	Meridian Platinum 36" top/rear direct vent fireplace with Intellifire Touch ignition (NG)	MAJ 1	\$ 4,689	Y	Y	14	14	N
MER36PL	Meridian Platinum 36" top/rear direct vent fireplace with Intellifire Touch ignition (LP)	MAJ 1	\$ 4,689	14	14	21	21	N

Fronts (Required to Complete)

Essence

ESSENCE36BK	Essence inside fit front - Black	MAJ 1	\$ 359	Y	Y	14	Y	Y
-------------	----------------------------------	-------	--------	---	---	----	---	---

Ventura

VENTURA36BK	Ventura overlap front - Black	MAJ 1	\$ 619	Y	14	14	14	Y
VENTURA36NB	Ventura overlap front - New Bronze	MAJ 1	\$ 669	14	14	14	14	Y

Manor

MANOR36BK	Manor arched overlap fit front with ClearVue mesh - Black	MAJ 1	\$ 1,019	Y	Y	14	14	Y
MANOR36NB	Manor arched overlap fit front with ClearVue mesh - New Bronze	MAJ 1	\$ 1,069	14	14	14	14	Y

Ensemble

ENSEMBLE36GM	Ensemble overlap front with ClearVue mesh and Gun Metal trim	MAJ 1	\$ 1,329	14	14	14	14	Y
ENSEMBLE36NB	Ensemble overlap front with ClearVue mesh and New Bronze trim	MAJ 1	\$ 1,379	Y	14	14	14	Y



Essence

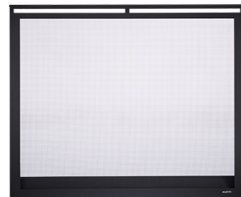

Ventura



Manor

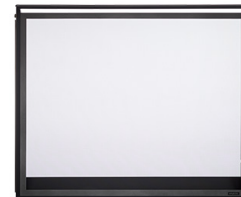

Ensemble

Liner Kit (Required to Complete)

Brick Refractory

BRICK36MPLTB	Brick Interior Panels - Traditional - Tavern Brown	MAJ 1	\$ 489	Y	28	14	14	Y
BRICK36MPLTBH	Brick Interior Panels - Herringbone - Tavern Brown	MAJ 1	\$ 509	Y	42	49	56	Y
BRICK36MPLCS	Brick Interior Panels - Castle Stone	MAJ 1	\$ 919	Y	14	14	14	Y

Liner Kit Black Glass Liner - 2 Sided								
GL-36MX	4 Pc - 2-Sided Reflective Black Glass/Matte Glass Liner	HTI 1	\$ 1,049	14	14	14	14	Y
Fans								
Fan								
GFK-160C	Fan kit 160 CFM (fan only)	HTI 1	\$ 259	Y	Y	Y	Y	Y
GFK-160A	Fan kit 160 CFM (includes rheostat and temperature sensor)	HTI 1	\$ 319	Y	Y	Y	Y	Y
Heat Management								
Heat Management								
PH-SIDETRIM	Passive Heat trim kit for side discharge (includes 2 side registers)(Starting collars sold separately)	HTI 1	\$ 108	Y	Y	Y	Y	Y
PH-FRTTRIM-36	Passive Heat Vent Trim Kit For Front Discharge (36")(Starting collars sold separately)	HTI 1	\$ 189	Y	Y	Y	21	Y
PH-MR	Passive Heat Kit starting collars (requires a side or front trim kit or use open top chase)	HTI 1	\$ 259	Y	Y	Y	Y	Y
Heat Out Kit								
HEAT-OUT-GAS	Heat out kit (includes termination cap, 25' of 6" round duct, fireplace adapter, damper, wall switch and 350CFM fan at termination)	HTI 1	\$ 1,489	Y	14	Y	14	Y
Heat Zone Kit								
HZMR-ADP	Required adaptor for HEAT-ZONE-GAS when not being paired with Passive Heat	HTI 0	\$ 102	Y	Y	Y	Y	Y
HEAT-ZONE-GAS	Heat-Zone Kit includes fan, 20' of 6" round duct, vent, wall adapter & on/off control. Wire Plug Assembly 26D0619 required if controlling w/RC400 remote. Used in IFT units with ACM & not a GFK fan. Compatible for up to 2 HEAT-ZONE-GAS kits. See manual.	HTI 1	\$ 549	Y	Y	Y	Y	Y
Control, remotes, wall switches								
Battery Back Up								
BATTERY-WSK	Battery backup wall switch kit for units with IFT control systems. Includes: On/Off Wall Switch, USB-C Port, Battery Backup, Cover Plate, 12' Wire Harness	HTI 1	\$ 179	Y	14	14	14	Y
IntelliFire app								
IFT-WFM	IntelliFire Wi-Fi Module that works with the IntelliFire iOS and Android app. Use to control all the features of your fireplace via a smart device. An RC400, RC450 or RC150 is required for thermostat control	HTI 1	\$ 219	Y	Y	Y	Y	Y
IntelliFire Touch Controls - Aux Module								
IFT-ACM	IntelliFire Touch AUX Module. Must order if adding Fan, Lights or Power Vent and want to use the IFT-WFM. Do not need to order if using IFT-RC400 (includes IFT-ACM).	HTI 1	\$ 96	14	Y	14	14	Y
Remote/Wall Switch/Wall Thermostat								
IFT-RC150	IntelliFire Touch white wireless wall switch (on/off, cold climate, battery strength indicator)	HTI 1	\$ 116	Y	14	14	Y	Y
Touch Screen Remote								
IFT-RC400	IntelliFire Touch black remote control, docking station and auxiliary control module (on/off, flame height, thermostat mode, fan control, child lock, cold climate, timer mode, hot indicator, lights, on-screen maintenance and troubleshooting notifications)	HTI 1	\$ 379	Y	Y	Y	Y	Y



Battery Back Up



IntelliFire app

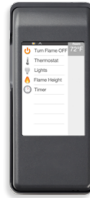

Touch Screen Remote

Venting

Brick Extension Kit

HEAT-OUT-BEK	Exterior Heat-Zone brick extension kit	HTI 1	\$	71	8	21	21	14	Y
--------------	----------------------------------------	-------	----	----	---	----	----	----	---

Venting Notes

Requires 8" DVP pipe.

Approved for use with SLP pipe. Restrictions apply. See Installation manual for venting specifications.

Approved for use with PVLV-SLP, PVI-SLP-B and PVV-SLP with power vent wire harness and IFT-RC400 remote (order separately). See venting section of manual.

Meridian 42

Includes:

- 19,000 - 35,000 Btu/Hour Input (NG)
- 17,000 - 34,000 Btu/Hour Input (LP)
- 12 ft Wall switch wire
- Tempered glass
- 6 ceramic fiber logs
- Glowing embers
- Battery backup
- IntelliFire Touch Ignition System
- Note: Flame adjustment requires RC400 or IFT-WFM



Required to Complete - Sold Separately: • Front

		Disc. Code	MSRP USD	004 IA	010 PA	014 CA	016 NC	EXP
MER42N	Meridian 42" top/rear direct vent fireplace with Intellifire Touch ignition (NG)	MAJ 1	\$ 3,869	Y	Y	14	Y	N
MER42L	Meridian 42" top/rear direct vent fireplace with Intellifire Touch ignition (LP)	MAJ 1	\$ 3,869	14	14	21	21	N

Fronts (Required to Complete)

Essence

ESSENCE42BK	Essence inside fit front - Black	MAJ 1	\$ 399	Y	Y	14	Y	Y
-------------	----------------------------------	-------	--------	---	---	----	---	---

Ventura

VENTURA42BK	Ventura overlap front - Black	MAJ 1	\$ 719	Y	14	14	14	Y
VENTURA42NB	Ventura overlap front - New Bronze	MAJ 1	\$ 769	14	14	14	14	Y

Manor

MANOR42BK	Manor arched overlap fit front with ClearVue mesh - Black	MAJ 1	\$ 1,129	14	14	14	14	Y
MANOR42NB	Manor arched overlap fit front with ClearVue mesh - New Bronze	MAJ 1	\$ 1,179	14	14	14	14	Y

Ensemble

ENSEMBLE42GM	Ensemble overlap front with ClearVue mesh and Gun Metal trim	MAJ 1	\$ 1,529	14	14	14	14	Y
ENSEMBLE42NB	Ensemble overlap front with ClearVue mesh and New Bronze trim	MAJ 1	\$ 1,589	14	14	14	14	Y



Essence



Ventura



Manor

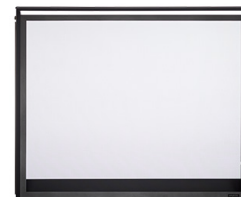

Ensemble

Liner Kit

Brick Refractory

BRICK42MTB	Brick Interior Panels - Traditional - Tavern Brown	MAJ 1	\$ 409	Y	14	21	28	Y
BRICK42MTBH	Brick Interior Panels - Herringbone - Tavern Brown	MAJ 1	\$ 449	Y	14	14	14	Y
BRICK42MCS	Brick Interior Panels - Castle Stone	MAJ 1	\$ 819	Y	14	14	14	Y

Liner Kit Black Glass Liner - 2 Sided

GL-42M	3 Pc - 2-Sided Reflective Black Glass/Matte Glass Liner	HTI 1	\$ 1,049	14	14	14	14	Y
--------	---------------------------------------------------------	-------	----------	----	----	----	----	---

Fans					
Fan					
GFK-160C	Fan kit 160 CFM (fan only)	HTI 1	\$ 259	Y	Y
GFK-160A	Fan kit 160 CFM (includes rheostat and temperature sensor)	HTI 1	\$ 319	Y	Y
Heat Management					
Heat Management					
PH-SIDETRIM	Passive Heat trim kit for side discharge (includes 2 side registers)(Starting collars sold separately)	HTI 1	\$ 108	Y	Y
PH-FRTRIM-42	Passive Heat Vent Trim Kit For Front Discharge (42")(Starting collars sold separately)	HTI 1	\$ 199	Y	Y
PH-MR	Passive Heat Kit starting collars (requires a side or front trim kit or use open top chase)	HTI 1	\$ 259	Y	Y
Heat Out Kit					
HEAT-OUT-GAS	Heat out kit (includes termination cap, 25' of 6" round duct, fireplace adapter, damper, wall switch and 350CFM fan at termination)	HTI 1	\$ 1,489	Y	14
Heat Zone Kit					
HZMR-ADP	Required adaptor for HEAT-ZONE-GAS when not being paired with Passive Heat	HTI 0	\$ 102	Y	Y
HEAT-ZONE-GAS	Heat-Zone Kit includes fan, 20' of 6" round duct, vent, wall adapter & on/off control. Wire Plug Assembly 26D0619 required if controlling w/RC400 remote. Used in IFT units with ACM & not a GFK fan. Compatible for up to 2 HEAT-ZONE-GAS kits. See manual.	HTI 1	\$ 549	Y	Y
Control, remotes, wall switches					
Battery Back Up					
BATTERY-WSK	Battery backup wall switch kit for units with IFT control systems. Includes: On/Off Wall Switch, USB-C Port, Battery Backup, Cover Plate, 12' Wire Harness	HTI 1	\$ 179	Y	14
IntelliFire app					
IFT-WFM	IntelliFire Wi-Fi Module that works with the IntelliFire iOS and Android app. Use to control all the features of your fireplace via a smart device. An RC400, RC450 or RC150 is required for thermostat control	HTI 1	\$ 219	Y	Y
IntelliFire Touch Controls - Aux Module					
IFT-ACM	IntelliFire Touch AUX Module. Must order if adding Fan, Lights or Power Vent and want to use the IFT-WFM. Do not need to order if using IFT-RC400 (includes IFT-ACM).	HTI 1	\$ 96	14	Y
Remote/Wall Switch/Wall Thermostat					
IFT-RC150	IntelliFire Touch white wireless wall switch (on/off, cold climate, battery strength indicator)	HTI 1	\$ 116	Y	14
Touch Screen Remote					
IFT-RC400	IntelliFire Touch black remote control, docking station and auxiliary control module (on/off, flame height, thermostat mode, fan control, child lock, cold climate, timer mode, hot indicator, lights, on-screen maintenance and troubleshooting notifications)	HTI 1	\$ 379	Y	Y



Battery Back Up



IntelliFire app

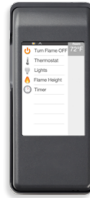

Touch Screen Remote

Venting

Brick Extension Kit

HEAT-OUT-BEK	Exterior Heat-Zone brick extension kit	HTI 1	\$	71	8	21	21	14	Y
--------------	----------------------------------------	-------	----	----	---	----	----	----	---

Venting Notes

Requires 8" DVP pipe.

Approved for use with SLP pipe. Restrictions apply. See Installation manual for venting specifications.

Approved for use with PVLV-SLP, PVI-SLP-B and PVV-SLP with power vent wire harness and IFT-RC400 remote (order separately). See venting section of manual.

Meridian 42 Modern

Includes:

- 18,000 - 36,000 Btu/Hour Input (NG)
- IntelliFire Touch ignition system
- Ceramic glass
- 12 ft wall switch wire
- 2 sided black ceramic glass liner
- STONES-NATURAL: 3 bags (must use with crushed glass media)
- Battery backup
- Note: Flame adjustment requires RC400 or IFT-WFM
- Please note: LP is not available for this fireplace



Required to Complete - Sold Separately: • Front • Crushed Glass Media (Qty 3)

		Disc. Code	MSRP USD	004 IA	010 PA	014 CA	016 NC	EXP
MER42MN	Meridian 42" Modern top direct vent gas fireplace with Intellifire Touch ignition (NG)	MAJ 1	\$ 4,499	14	14	21	21	N

Fronts (Required to Complete)

Essence

ESSENCE42BK	Essence inside fit front - Black	MAJ 1	\$ 399	Y	Y	14	Y	Y
-------------	----------------------------------	-------	--------	---	---	----	---	---

Ventura

VENTURA42BK	Ventura overlap front - Black	MAJ 1	\$ 719	Y	14	14	14	Y
VENTURA42NB	Ventura overlap front - New Bronze	MAJ 1	\$ 769	14	14	14	14	Y

Manor

MANOR42BK	Manor arched overlap fit front with ClearVue mesh - Black	MAJ 1	\$ 1,129	14	14	14	14	Y
MANOR42NB	Manor arched overlap fit front with ClearVue mesh - New Bronze	MAJ 1	\$ 1,179	14	14	14	14	Y

Ensemble

ENSEMBLE42GM	Ensemble overlap front with ClearVue mesh and Gun Metal trim	MAJ 1	\$ 1,529	14	14	14	14	Y
ENSEMBLE42NB	Ensemble overlap front with ClearVue mesh and New Bronze trim	MAJ 1	\$ 1,589	14	14	14	14	Y



Essence

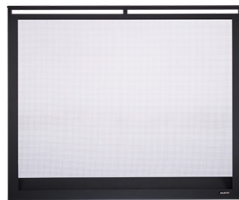

Ventura



Manor



Ensemble

Media (Required to Complete)

Crushed Glass Media

MEDIA-CP	Copper Embers - Crushed Glass Media (1 bag, 5lbs)	HTI 1	\$ 75	Y	Y	Y	Y	Y
MEDIA-CY	Crystal Embers - Crushed Glass Media (1 bag, 5lbs)	HTI 1	\$ 75	Y	Y	Y	Y	Y
MEDIA-GT	Graphite Embers - Crushed Glass Media (1 bag, 5lbs)	HTI 1	\$ 75	Y	Y	Y	Y	Y
MEDIA-SM	Smoked Embers - Crushed Glass Media (1 bag, 5lbs)	HTI 1	\$ 75	Y	Y	Y	Y	Y

Stones										
STONES-NATURAL	Natural stones (1 bag)	HTI 1	\$	111	Y	Y	Y	Y	Y	Y
Gas Logs - Log Set Option										
Logs										
LOGS-KMOD	Driftwood Logs (must use Crushed Glass Media)	HTI 1	\$	509	Y	14	14	14	14	Y
Fans										
Fan										
GFK-160C	Fan kit 160 CFM (fan only)	HTI 1	\$	259	Y	Y	Y	Y	Y	Y
GFK-160A	Fan kit 160 CFM (includes rheostat and temperature sensor)	HTI 1	\$	319	Y	Y	Y	Y	Y	Y
Heat Management										
Heat Management										
PH-SIDETRIM	Passive Heat trim kit for side discharge (includes 2 side registers)(Starting collars sold separately)	HTI 1	\$	108	Y	Y	Y	Y	Y	Y
PH-FRTTRIM-42	Passive Heat Vent Trim Kit For Front Discharge (42")(Starting collars sold separately)	HTI 1	\$	199	Y	Y	Y	Y	Y	Y
PH-MR	Passive Heat Kit starting collars (requires a side or front trim kit or use open top chase)	HTI 1	\$	259	Y	Y	Y	Y	Y	Y
Heat Out Kit										
HEAT-OUT-GAS	Heat out kit (includes termination cap, 25' of 6" round duct, fireplace adapter, damper, wall switch and 350CFM fan at termination)	HTI 1	\$	1,489	Y	14	Y	14	Y	Y
Heat Zone Kit										
HZMR-ADP	Required adaptor for HEAT-ZONE-GAS when not being paired with Passive Heat	HTI 0	\$	102	Y	Y	Y	Y	Y	Y
HEAT-ZONE-GAS	Heat-Zone Kit includes fan, 20' of 6" round duct, vent, wall adapter & on/off control. Wire Plug Assembly 26D0619 required if controlling w/RC400 remote. Used in IFT units with ACM & not a GFK fan. Compatible for up to 2 HEAT-ZONE-GAS kits. See manual.	HTI 1	\$	549	Y	Y	Y	Y	Y	Y
Control, remotes, wall switches										
Battery Back Up										
BATTERY-WSK	Battery backup wall switch kit for units with IFT control systems. Includes: On/Off Wall Switch, USB-C Port, Battery Backup, Cover Plate, 12' Wire Harness	HTI 1	\$	179	Y	14	14	14	14	Y
IntelliFire app										
IFT-WFM	IntelliFire Wi-Fi Module that works with the IntelliFire iOS and Android app. Use to control all the features of your fireplace via a smart device. An RC400, RC450 or RC150 is required for thermostat control	HTI 1	\$	219	Y	Y	Y	Y	Y	Y
IntelliFire Touch Controls - Aux Module										
IFT-ACM	IntelliFire Touch AUX Module. Must order if adding Fan, Lights or Power Vent and want to use the IFT-WFM. Do not need to order if using IFT-RC400 (includes IFT-ACM).	HTI 1	\$	96	14	Y	14	14	14	Y
Remote/Wall Switch/Wall Thermostat										
IFT-RC150	IntelliFire Touch white wireless wall switch (on/off, cold climate, battery strength indicator)	HTI 1	\$	116	Y	14	14	Y	Y	Y

Touch Screen Remote

IFT-RC400	IntelliFire Touch black remote control, docking station and auxiliary control module (on/off, flame height, thermostat mode, fan control, child lock, cold climate, timer mode, hot indicator, lights, on-screen maintenance and troubleshooting notifications)	HTI 1	\$ 379	Y	Y	Y	Y	Y
-----------	-----------------------------------------------------------------------------------------------------------------------------------------------------------------------------------------------------------------------------------------------------------------	-------	--------	---	---	---	---	---



Battery Back Up



IntelliFire app

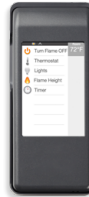

Touch Screen Remote

Venting

Brick Extension Kit

HEAT-OUT-BEK	Exterior Heat-Zone brick extension kit	HTI 1	\$ 71	8	21	21	14	Y
--------------	----------------------------------------	-------	-------	---	----	----	----	---

Venting Notes

Requires 8" DVP pipe. Must have a 6" minimum vertical vent before attaching a 90 degree elbow to the fireplace. See Venting section.

Approved for use with SLP pipe. Restrictions apply. See Installation manual for venting specifications.

Approved for use with PVLP-SLP, PVI-SLP-B and PVV-SLP with power vent wire harness and IFT-RC400 remote (order separately). See venting section of manual.

Meridian 42 Platinum

Includes:

- 23,000 - 45,000 Btu/Hour Input (NG)
- 23,000 - 44,000 Btu/Hour Input (LP)
- Ceramic glass
- 6 Ceramic fiber logs
- LED Accent lighting (not used with Black glass liner)
- GFK-160 variable speed fan
- Battery backup
- LED illuminated embers
- RC-400 Touchscreen remote control
- IntelliFire Touch Ignition System



Required to Complete - Sold Separately: • Front • Liner Kit

		Disc. Code	MSRP USD	004 IA	010 PA	014 CA	016 NC	EXP
MER42PN	Meridian Platinum 42" top/rear direct vent fireplace with Intellifire Touch ignition (NG)	MAJ 1	\$ 5,369	14	14	21	21	N
MER42PL	Meridian Platinum 42" top/rear direct vent fireplace with Intellifire Touch ignition (LP)	MAJ 1	\$ 5,369	14	14	21	21	N

Fronts (Required to Complete)

Essence

ESSENCE42BK	Essence inside fit front - Black	MAJ 1	\$ 399	Y	Y	14	Y	Y
-------------	----------------------------------	-------	--------	---	---	----	---	---

Ventura

VENTURA42BK	Ventura overlap front - Black	MAJ 1	\$ 719	Y	14	14	14	Y
VENTURA42NB	Ventura overlap front - New Bronze	MAJ 1	\$ 769	14	14	14	14	Y

Manor

MANOR42BK	Manor arched overlap fit front with ClearVue mesh - Black	MAJ 1	\$ 1,129	14	14	14	14	Y
MANOR42NB	Manor arched overlap fit front with ClearVue mesh - New Bronze	MAJ 1	\$ 1,179	14	14	14	14	Y

Ensemble

ENSEMBLE42GM	Ensemble overlap front with ClearVue mesh and Gun Metal trim	MAJ 1	\$ 1,529	14	14	14	14	Y
ENSEMBLE42NB	Ensemble overlap front with ClearVue mesh and New Bronze trim	MAJ 1	\$ 1,589	14	14	14	14	Y



Essence



Ventura



Manor

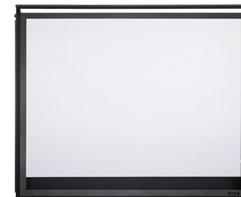

Ensemble

Liner Kit (Required to Complete)

Brick Refractory

BRICK42MPLTB	Brick Interior Panels - Traditional - Tavern Brown	MAJ 1	\$ 479	Y	42	49	56	Y
BRICK42MPLTBH	Brick Interior Panels - Herringbone - Tavern Brown	MAJ 1	\$ 479	Y	28	35	42	Y
BRICK42MPLCS	Brick Interior Panels - Castle Stone	MAJ 1	\$ 1,019	Y	21	28	35	Y

Liner Kit Black Glass Liner - 2 Sided										
GL-42MX	4 Pc - 2-Sided Reflective Black Glass/Matte Glass Liner	HTI 1	\$ 1,259	14	14	14	14	Y		
Fans										
Fan										
GFK-160C	Fan kit 160 CFM (fan only)	HTI 1	\$ 259	Y	Y	Y	Y	Y		
GFK-160A	Fan kit 160 CFM (includes rheostat and temperature sensor)	HTI 1	\$ 319	Y	Y	Y	Y	Y		
Heat Management										
Heat Management										
PH-SIDETRIM	Passive Heat trim kit for side discharge (includes 2 side registers)(Starting collars sold separately)	HTI 1	\$ 108	Y	Y	Y	Y	Y		
PH-FRTTRIM-42	Passive Heat Vent Trim Kit For Front Discharge (42")(Starting collars sold separately)	HTI 1	\$ 199	Y	Y	Y	Y	Y		
PH-MR	Passive Heat Kit starting collars (requires a side or front trim kit or use open top chase)	HTI 1	\$ 259	Y	Y	Y	Y	Y		
Heat Out Kit										
HEAT-OUT-GAS	Heat out kit (includes termination cap, 25' of 6" round duct, fireplace adapter, damper, wall switch and 350CFM fan at termination)	HTI 1	\$ 1,489	Y	14	Y	14	Y		
Heat Zone Kit										
HZMR-ADP	Required adaptor for HEAT-ZONE-GAS when not being paired with Passive Heat	HTI 0	\$ 102	Y	Y	Y	Y	Y		
HEAT-ZONE-GAS	Heat-Zone Kit includes fan, 20' of 6" round duct, vent, wall adapter & on/off control. Wire Plug Assembly 26D0619 required if controlling w/RC400 remote. Used in IFT units with ACM & not a GFK fan. Compatible for up to 2 HEAT-ZONE-GAS kits. See manual.	HTI 1	\$ 549	Y	Y	Y	Y	Y		
Control, remotes, wall switches										
Battery Back Up										
BATTERY-WSK	Battery backup wall switch kit for units with IFT control systems. Includes: On/Off Wall Switch, USB-C Port, Battery Backup, Cover Plate, 12' Wire Harness	HTI 1	\$ 179	Y	14	14	14	Y		
IntelliFire app										
IFT-WFM	IntelliFire Wi-Fi Module that works with the IntelliFire iOS and Android app. Use to control all the features of your fireplace via a smart device. An RC400, RC450 or RC150 is required for thermostat control	HTI 1	\$ 219	Y	Y	Y	Y	Y		
IntelliFire Touch Controls - Aux Module										
IFT-ACM	IntelliFire Touch AUX Module. Must order if adding Fan, Lights or Power Vent and want to use the IFT-WFM. Do not need to order if using IFT-RC400 (includes IFT-ACM).	HTI 1	\$ 96	14	Y	14	14	Y		
Remote/Wall Switch/Wall Thermostat										
IFT-RC150	IntelliFire Touch white wireless wall switch (on/off, cold climate, battery strength indicator)	HTI 1	\$ 116	Y	14	14	Y	Y		
Touch Screen Remote										
IFT-RC400	IntelliFire Touch black remote control, docking station and auxiliary control module (on/off, flame height, thermostat mode, fan control, child lock, cold climate, timer mode, hot indicator, lights, on-screen maintenance and troubleshooting notifications)	HTI 1	\$ 379	Y	Y	Y	Y	Y		



Battery Back Up



IntelliFire app

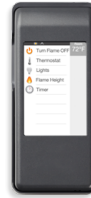

Touch Screen Remote

Venting

Brick Extension Kit

HEAT-OUT-BEK	Exterior Heat-Zone brick extension kit	HTI 1	\$	71	8	21	21	14	Y
--------------	----------------------------------------	-------	----	----	---	----	----	----	---

Venting Notes

Requires 8" DVP pipe.

Approved for use with SLP pipe. Restrictions apply. See Installation manual for venting specifications.

Approved for use with PVLV-SLP, PVI-SLP-B and PVV-SLP with power vent wire harness (order separately) and IFT-RC400 remote. See venting section of manual.

Quartz 32 w/ IFT

Includes:

- 15,000 - 21,000 Btu/Hour Input (NG)
- 14,000 - 18,500 Btu/Hour Input (LP)
- 5" x 8" rear vent collar
- 4" x 6 5/8" top vent collar
- 8 ceramic fiber logs
- Full firescreen front and hood
- Tempered glass
- Glowing embers
- Battery backup
- 12' control wire
- Convertible to contemporary
- IntelliFire ignition
- Note: to change contemporary media color requires 2 bags



No additional items required to complete.

		Disc. Code	MSRP USD	004 IA	010 PA	014 CA	016 NC	EXP
QUARTZ32IFTL	Quartz 32" top/rear direct vent fireplace with IntelliFire Touch ignition (LP)	MAJ 1	\$ 2,189	Y	Y	14	Y	N
QUARTZ32IFTN	Quartz 32" top/rear direct vent fireplace with IntelliFire Touch ignition (NG)	MAJ 1	\$ 2,189	Y	Y	Y	Y	N

Conversion Kit

Conversion Kits

CK32	Contemporary conversion kit for Quartz 32- includes 2 bags media and stones	MAJ 1	\$ 329	14	Y	Y	14	Y
------	-----------------------------------------------------------------------------	-------	--------	----	---	---	----	---

Media

Media

GLASS-BZ	Glass, Bronze (1 bag)	MAJ 1	\$ 71	Y	21	14	14	Y
GLASS-DM	Glass, Diamond (1 bag)	MAJ 1	\$ 71	Y	Y	14	Y	Y
GLASS-SP	Glass, Sapphire (1 bag)	MAJ 1	\$ 71	Y	Y	14	14	Y
GLASS-OY	Glass, Onyx (1 bag)	MAJ 1	\$ 71	Y	Y	14	Y	Y

Refractory

Liner Kit (MAJ)

GLQUARTZ32	Black glass interior panels 32"	MAJ 1	\$ 589	14	14	14	14	Y
------------	---------------------------------	-------	--------	----	----	----	----	---

Liner Kit

Brick Panels

BRICK32CR	Brick interior panels 32" - Cottage Red	MAJ 1	\$ 359	14	21	14	14	Y
BRICK32TB	Brick interior panels 32" - Tavern Brown	MAJ 1	\$ 359	14	14	14	14	Y

Fans

Fan

GFK-160C	Fan kit 160 CFM (fan only)	HTI 1	\$ 259	Y	Y	Y	Y	Y
GFK-160A	Fan kit 160 CFM (includes rheostat and temperature sensor)	HTI 1	\$ 319	Y	Y	Y	Y	Y

Trim Kits

Trim Kit 550

550-TRIM3-BK-B	Trim Kit, 3 Sided - Black (not for use with Clean Face Kit)	HTI 1	\$ 299	Y	Y	Y	14	Y
550-TRIM4-BK-B	Trim Kit, 4 Sided - Black (not for use with Clean Face Kit)	HTI 1	\$ 359	Y	14	Y	14	Y

Heat Management					
Heat Zone Kit					
HEAT-ZONE-GAS	Heat-Zone Kit includes fan, 20' of 6" round duct, vent, wall adapter & on/off control. Wire Plug Assembly 26D0619 required if controlling w/RC400 remote. Used in IFT units with ACM & not a GFK fan. Compatible for up to 2 HEAT-ZONE-GAS kits. See manual.	HTI 1	\$ 549	Y	Y
Control, remotes, wall switches					
Battery Back Up					
BATTERY-WSK	Battery backup wall switch kit for units with IFT control systems. Includes: On/Off Wall Switch, USB-C Port, Battery Backup, Cover Plate, 12' Wire Harness	HTI 1	\$ 179	Y	14
IntelliFire app					
IFT-WFM	IntelliFire Wi-Fi Module that works with the IntelliFire iOS and Android app. Use to control all the features of your fireplace via a smart device. An RC400, RC450 or RC150 is required for thermostat control	HTI 1	\$ 219	Y	Y
IntelliFire Touch Controls - Aux Module					
IFT-ACM	IntelliFire Touch AUX Module. Must order if adding Fan, Lights or Power Vent and want to use the IFT-WFM. Do not need to order if using IFT-RC400 (includes IFT-ACM).	HTI 1	\$ 96	14	Y
Remote/Wall Switch/Wall Thermostat					
IFT-RC150	IntelliFire Touch white wireless wall switch (on/off, cold climate, battery strength indicator)	HTI 1	\$ 116	Y	14
Touch Screen Remote					
IFT-RC400	IntelliFire Touch black remote control, docking station and auxiliary control module (on/off, flame height, thermostat mode, fan control, child lock, cold climate, timer mode, hot indicator, lights, on-screen maintenance and troubleshooting notifications)	HTI 1	\$ 379	Y	Y
Wall Switch					
WSK-21-W	Wall switch kit- White (includes 20 ft of wire)	HTI 1	\$ 40	Y	Y



Battery Back Up



IntelliFire app

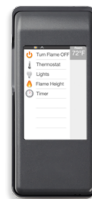

Touch Screen Remote

Venting					
Brick Extension Kit					
HEAT-OUT-BEK	Exterior Heat-Zone brick extension kit	HTI 1	\$ 71	8	21

Venting Notes					
Requires SLP series or SLP-Flex series pipe when venting off top of unit. See Venting section.					
Requires DVP series pipe when venting off rear of unit. See Venting section.					
Approved for use with PVL-PSLP, PVI-SLP-B and PVV-SLP with PV-IPI-CK kit, power vent wire harness and RC100, 200 or 300 control (order separately). See venting section of manual.					

Quartz 36 Platinum

Includes:

- 17,500 - 30,500 Btu/Hour Input (NG)
- 18,000 - 29,500 Btu/Hour Input (LP)
- 5" x 8" rear vent collar
- 4" x 6 5/8" top vent collar
- 8 ceramic fiber logs
- Ceramic glass
- LED illuminated embers
- RC400 touchscreen remote
- Glowing embers
- Battery backup
- External air shutter adjustment
- GFK-160 variable speed blower
- IntelliFire Touch ignition



Required to Complete - Sold Separately: • Front

		Disc.	MSRP	004	010	014	016	EXP
		Code	USD	IA	PA	CA	NC	
QUARTZPLA36IL	Quartz Platinum top/rear direct vent fireplace with Intellifire Touch ignition (LP)	MAJ 1	\$ 3,469	Y	Y	14	14	N
QUARTZPLA36IN	Quartz Platinum top/rear direct vent fireplace with Intellifire Touch ignition (NG)	MAJ 1	\$ 3,469	Y	14	14	14	N

Fronts - Non-Operable (Required to Complete)

Contemporary Rectangular Door

CRD36BK	Contemporary Rectangular Door 36" overlap front - Black	MAJ 1	\$ 869	14	14	14	14	Y
---------	---------------------------------------------------------	-------	--------	----	----	----	----	---

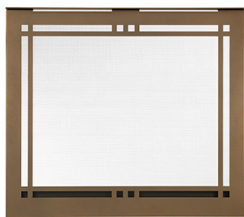

Contemporary Rectangular Door

Refractory (Required to Complete)

Liner Kit (MAJ)

GLQUARTZ36PLA	Reflective black glass interior panels	MAJ 1	\$ 739	Y	Y	14	14	Y
---------------	----------------------------------------	-------	--------	---	---	----	----	---

Refractory

BRICK36TBPLA	Brick interior panels 36" - Tavern Brown	MAJ 1	\$ 449	Y	Y	49	115	Y
--------------	------------------------------------------	-------	--------	---	---	----	-----	---

Trim Kits

Trim Kits

750-TRIM3-BK-B	Trim Kit, 3 Sided - Black (not for use with Clean Face Kit)	HTI 1	\$ 319	Y	14	14	14	Y
750-TRIM4-BK-B	Trim Kit, 4 Sided - Black (not for use with Clean Face Kit)	HTI 1	\$ 369	Y	14	Y	14	Y

Heat Management

Heat Zone Kit

HEAT-ZONE-GAS	Heat-Zone Kit includes fan, 20' of 6" round duct, vent, wall adapter & on/off control. Wire Plug Assembly 26D0619 required if controlling w/RC400 remote. Used in IFT units with ACM & not a GFK fan. Compatible for up to 2 HEAT-ZONE-GAS kits. See manual.	HTI 1	\$ 549	Y	Y	Y	Y	Y
---------------	--------------------------------------------------------------------------------------------------------------------------------------------------------------------------------------------------------------------------------------------------------------	-------	--------	---	---	---	---	---

Control, remotes, wall switches

IntelliFire app

IFT-WFM	IntelliFire Wi-Fi Module that works with the IntelliFire iOS and Android app. Use to control all the features of your fireplace via a smart device. An RC400, RC450 or RC150 is required for thermostat control	HTI 1	\$	219	Y	Y	Y	Y	Y
---------	-----------------------------------------------------------------------------------------------------------------------------------------------------------------------------------------------------------------	-------	----	-----	---	---	---	---	---

IntelliFire Touch Controls - Aux Module

IFT-ACM	IntelliFire Touch AUX Module. Must order if adding Fan, Lights or Power Vent and want to use the IFT-WFM. Do not need to order if using IFT-RC400 (includes IFT-ACM).	HTI 1	\$	96	14	Y	14	14	Y
---------	-----------------------------------------------------------------------------------------------------------------------------------------------------------------------	-------	----	----	----	---	----	----	---

Remote/Wall Switch/Wall Thermostat

IFT-RC150	IntelliFire Touch white wireless wall switch (on/off, cold climate, battery strength indicator)	HTI 1	\$	116	Y	14	14	Y	Y
-----------	-------------------------------------------------------------------------------------------------	-------	----	-----	---	----	----	---	---

Touch Screen Remote

IFT-RC400	IntelliFire Touch black remote control, docking station and auxiliary control module (on/off, flame height, thermostat mode, fan control, child lock, cold climate, timer mode, hot indicator, lights, on-screen maintenance and troubleshooting notifications)	HTI 1	\$	379	Y	Y	Y	Y	Y
-----------	-----------------------------------------------------------------------------------------------------------------------------------------------------------------------------------------------------------------------------------------------------------------	-------	----	-----	---	---	---	---	---



IntelliFire app



Touch Screen Remote

Venting

Brick Extension Kit

HEAT-OUT-BEK	Exterior Heat-Zone brick extension kit	HTI 1	\$	71	8	21	21	14	Y
--------------	----------------------------------------	-------	----	----	---	----	----	----	---

Venting Notes

Requires SLP series or SLP-Flex series pipe when venting off top of unit. See Venting section.

Requires DVP series pipe when venting off rear of unit. See Venting section.

Approved for use with PVL-PSLP, PVI-SLP-B and PVV-SLP with power vent wire harness (order separately) and IFT-RC400 remote. See venting section of manual.

Quartz 36 w/ IFT

Includes:

- 17,000 - 24,000 Btu/Hour Input (NG)
- 16,000 - 20,500 Btu/Hour Input (LP)
- 5" x 8" rear vent collar
- 4" x 6 5/8" top vent collar
- 8 ceramic fiber logs
- Full firescreen front and hood
- Tempered glass
- Glowing embers
- Battery backup
- 12' control wire
- Convertible to contemporary
- IntelliFire ignition
- Note: to change contemporary media color requires 2 bags



No additional items required to complete.

		Disc. Code	MSRP USD	004 IA	010 PA	014 CA	016 NC	EXP
QUARTZ36IFTN	Quartz 36" top/rear direct vent fireplace with IntelliFire Touch ignition (NG)	MAJ 1	\$ 2,599	Y	Y	Y	Y	N
QUARTZ36IFTL	Quartz 36" top/rear direct vent fireplace with IntelliFire Touch ignition (LP)	MAJ 1	\$ 2,599	Y	Y	14	Y	N

Conversion Kit

Conversion Kits

CK36	Contemporary conversion kit for Quartz 36- includes 2 bags media and stones	MAJ 1	\$ 359	14	14	14	14	Y
------	-----------------------------------------------------------------------------	-------	--------	----	----	----	----	---

Media

Media

GLASS-BZ	Glass, Bronze (1 bag)	MAJ 1	\$ 71	Y	21	14	14	Y
GLASS-OY	Glass, Onyx (1 bag)	MAJ 1	\$ 71	Y	Y	14	Y	Y
GLASS-DM	Glass, Diamond (1 bag)	MAJ 1	\$ 71	Y	Y	14	Y	Y
GLASS-SP	Glass, Sapphire (1 bag)	MAJ 1	\$ 71	Y	Y	14	14	Y

Refractory

Liner Kit (MAJ)

GLQUARTZ36	Black glass interior panels 36"	MAJ 1	\$ 659	Y	Y	14	14	Y
------------	---------------------------------	-------	--------	---	---	----	----	---

Liner Kit

Brick Panels

BRICK36CR	Brick interior panels 36" - Cottage Red	MAJ 1	\$ 399	14	21	14	14	Y
BRICK36TB	Brick interior panels 36" - Tavern Brown	MAJ 1	\$ 399	14	Y	Y	Y	Y

Fans

Fan

GFK-160C	Fan kit 160 CFM (fan only)	HTI 1	\$ 259	Y	Y	Y	Y	Y
GFK-160A	Fan kit 160 CFM (includes rheostat and temperature sensor)	HTI 1	\$ 319	Y	Y	Y	Y	Y

Trim Kits

Trim Kits

750-TRIM3-BK-B	Trim Kit, 3 Sided - Black (not for use with Clean Face Kit)	HTI 1	\$ 319	Y	14	14	14	Y
750-TRIM4-BK-B	Trim Kit, 4 Sided - Black (not for use with Clean Face Kit)	HTI 1	\$ 369	Y	14	Y	14	Y

Heat Management					
Heat Zone Kit					
HEAT-ZONE-GAS	Heat-Zone Kit includes fan, 20' of 6" round duct, vent, wall adapter & on/off control. Wire Plug Assembly 26D0619 required if controlling w/RC400 remote. Used in IFT units with ACM & not a GFK fan. Compatible for up to 2 HEAT-ZONE-GAS kits. See manual.	HTI 1	\$ 549	Y	Y
Control, remotes, wall switches					
Battery Back Up					
BATTERY-WSK	Battery backup wall switch kit for units with IFT control systems. Includes: On/Off Wall Switch, USB-C Port, Battery Backup, Cover Plate, 12' Wire Harness	HTI 1	\$ 179	Y	14
IntelliFire app					
IFT-WFM	IntelliFire Wi-Fi Module that works with the IntelliFire iOS and Android app. Use to control all the features of your fireplace via a smart device. An RC400, RC450 or RC150 is required for thermostat control	HTI 1	\$ 219	Y	Y
IntelliFire Touch Controls - Aux Module					
IFT-ACM	IntelliFire Touch AUX Module. Must order if adding Fan, Lights or Power Vent and want to use the IFT-WFM. Do not need to order if using IFT-RC400 (includes IFT-ACM).	HTI 1	\$ 96	14	Y
Remote/Wall Switch/Wall Thermostat					
IFT-RC150	IntelliFire Touch white wireless wall switch (on/off, cold climate, battery strength indicator)	HTI 1	\$ 116	Y	14
Touch Screen Remote					
IFT-RC400	IntelliFire Touch black remote control, docking station and auxiliary control module (on/off, flame height, thermostat mode, fan control, child lock, cold climate, timer mode, hot indicator, lights, on-screen maintenance and troubleshooting notifications)	HTI 1	\$ 379	Y	Y
Wall Switch					
WSK-21-W	Wall switch kit- White (includes 20 ft of wire)	HTI 1	\$ 40	Y	Y



Battery Back Up



IntelliFire app

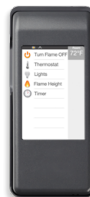

Touch Screen Remote

Venting					
Brick Extension Kit					
HEAT-OUT-BEK	Exterior Heat-Zone brick extension kit	HTI 1	\$ 71	8	21

Venting Notes					
Requires SLP series or SLP-Flex series pipe when venting off top of unit. See Venting section.					
Requires DVP series pipe when venting off rear of unit. See Venting section.					
Approved for use with PVL-PSLP, PVI-SLP-B and PVV-SLP with PV-IPI-CK kit, power vent wire harness and RC100, 200 or 300 control (order separately). See venting section of manual.					

Quartz 42 w/ IFT

Includes:

- 20,000 - 28,500 Btu/Hour Input (NG)
- 19,500 - 26,000 Btu/Hour Input (LP)
- 5" x 8" rear vent collar
- 4" x 6 5/8" top vent collar
- 8 ceramic fiber logs
- Full firescreen front and hood
- Tempered glass
- Glowing embers
- Battery backup
- 12' control wire
- IntelliFire ignition



No additional items required to complete.

		Disc. Code	MSRP USD	004 IA	010 PA	014 CA	016 NC	EXP
QUARTZ42IFTL	Quartz 42" top/rear direct vent fireplace with IntelliFire Touch ignition (LP)	MAJ 1	\$ 2,809	14	Y	14	Y	N
QUARTZ42IFTN	Quartz 42" top/rear direct vent fireplace with IntelliFire Touch ignition (NG)	MAJ 1	\$ 2,809	Y	Y	14	Y	N

Refractory

REFRACTORY/BRICK

BRICK42TB	Brick interior panels 42" - Tavern Brown	MAJ 1	\$ 549	14	14	14	14	Y
BRICK42CR	Brick interior panels 42" - Cottage Red	MAJ 1	\$ 549	14	21	14	14	Y
GLQUARTZ42	Black glass interior panels 42"	MAJ 1	\$ 689	14	14	14	14	Y

Fans

Fan

GFK-160C	Fan kit 160 CFM (fan only)	HTI 1	\$ 259	Y	Y	Y	Y	Y
GFK-160A	Fan kit 160 CFM (includes rheostat and temperature sensor)	HTI 1	\$ 319	Y	Y	Y	Y	Y

Heat Management

Heat Zone Kit

HEAT-ZONE-GAS	Heat-Zone Kit includes fan, 20' of 6" round duct, vent, wall adapter & on/off control. Wire Plug Assembly 26D0619 required if controlling w/RC400 remote. Used in IFT units with ACM & not a GFK fan. Compatible for up to 2 HEAT-ZONE-GAS kits. See manual.	HTI 1	\$ 549	Y	Y	Y	Y	Y
---------------	--------------------------------------------------------------------------------------------------------------------------------------------------------------------------------------------------------------------------------------------------------------	-------	--------	---	---	---	---	---

Control, remotes, wall switches

Battery Back Up

BATTERY-WSK	Battery backup wall switch kit for units with IFT control systems. Includes: On/Off Wall Switch, USB-C Port, Battery Backup, Cover Plate, 12' Wire Harness	HTI 1	\$ 179	Y	14	14	14	Y
-------------	------------------------------------------------------------------------------------------------------------------------------------------------------------	-------	--------	---	----	----	----	---

IntelliFire app

IFT-WFM	IntelliFire Wi-Fi Module that works with the IntelliFire iOS and Android app. Use to control all the features of your fireplace via a smart device. An RC400, RC450 or RC150 is required for thermostat control	HTI 1	\$ 219	Y	Y	Y	Y	Y
---------	-----------------------------------------------------------------------------------------------------------------------------------------------------------------------------------------------------------------	-------	--------	---	---	---	---	---

IntelliFire Touch Controls - Aux Module

IFT-ACM	IntelliFire Touch AUX Module. Must order if adding Fan, Lights or Power Vent and want to use the IFT-WFM. Do not need to order if using IFT-RC400 (includes IFT-ACM).	HTI 1	\$ 96	14	Y	14	14	Y
---------	-----------------------------------------------------------------------------------------------------------------------------------------------------------------------	-------	-------	----	---	----	----	---

Remote/Wall Switch/Wall Thermostat

IFT-RC150	IntelliFire Touch white wireless wall switch (on/off, cold climate, battery strength indicator)	HTI 1	\$	116	Y	14	14	Y	Y
-----------	-------------------------------------------------------------------------------------------------	-------	----	-----	---	----	----	---	---

Touch Screen Remote

IFT-RC400	IntelliFire Touch black remote control, docking station and auxiliary control module (on/off, flame height, thermostat mode, fan control, child lock, cold climate, timer mode, hot indicator, lights, on-screen maintenance and troubleshooting notifications)	HTI 1	\$	379	Y	Y	Y	Y	Y
-----------	-----------------------------------------------------------------------------------------------------------------------------------------------------------------------------------------------------------------------------------------------------------------	-------	----	-----	---	---	---	---	---



Battery Back Up



IntelliFire app

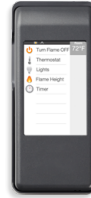

Touch Screen Remote

Venting

Brick Extension Kit

HEAT-OUT-BEK	Exterior Heat-Zone brick extension kit	HTI 1	\$	71	8	21	21	14	Y
--------------	----------------------------------------	-------	----	----	---	----	----	----	---

Venting Notes

Requires SLP series or SLP-Flex series pipe when venting off top of unit. See Venting section.

Requires DVP series pipe when venting off rear of unit. See Venting section.

Approved for use with PVL-PSLP, PVI-SLP-B and PVV-SLP with PV-IPI-CK kit, power vent wire harness and RC100, 200 or 300 control (order separately). See venting section of manual.

Majestic	Fireplace - Gas - Freestanding	Stocked Item/Lead Time 004=Mt. Pleasant RDC 010=Kutztown RDC 014=Sacramento RDC 016=Charlotte RDC EXP=Factory Expedite Program
-----------------	---------------------------------------	-----------------------------------------------------------------------------------------------------------------------------------------------

Page printed 2/1/2024 3:05:35 PM CST
 Future pricing effective for shipments on or after 03/31/2024
 * Please Contact Who You Purchase This Through for MSRP Pricing

Prices in USD
 Non-stock and custom product cannot be cancelled.
 Customer is responsible for freight for orders made outside of assigned RDC facility.

Ruby Freestanding 30"

Includes:

- 22,890 - 32,700 BTU/Hour Input (NG)
- 22,400 - 32,000 BTU/Hour Input (LP)
- IntelliFire Touch Ignition System
- RC400 Remote Control
- GFK-160A Variable Fan
- Ceramic Glass
- Glowing Embers/Mystic Embers
- Battery Back Up
- Electrical Cord - 10' 3" Left
- Gas Flex Connector
- 8 Ceramic Fiber Split Logs



Required to Complete - Sold Separately:

- INFIT-30-BK
- ADP-CK30
- CK-30

		Disc. Code	MSRP USD	004 IA	010 PA	014 CA	016 NC	EXP
RUBY30IN	Medium 30" direct vent gas fireplace insert with intellifire touch system (NG)	MAJ 3	\$ 2,879	Y	Y	Y	14	N
RUBY30IL	Medium 30" direct vent gas fireplace insert with intellifire touch system (LP)	MAJ 3	\$ 2,879	Y	Y	14	14	N

Fronts - Non-Operable (Required to Complete)

Inside Fit

INFIT-30-BK	Inside fit 30" screen front - Black	HTI 3	\$ 359	Y	Y	Y	14	Y
-------------	-------------------------------------	-------	--------	---	---	---	----	---



Inside Fit

Cabinet (Required to Complete)

Cabinet - Steel

CK-30	Steel cabinet with pedestal base for use with 30" gas inserts	HTI 3	\$ 999	Y	Y	Y	14	N
-------	---------------------------------------------------------------	-------	--------	---	---	---	----	---

Venting (Required to Complete)

Adaptor

ADP-CK30	Adapter kit (required for use with CK-30)	HTI 3	\$ 210	Y	Y	Y	14	Y
----------	-------------------------------------------	-------	--------	---	---	---	----	---

Lighting					
Accent Light Kit					
MI-ALK	Ambient Light Kit (not for use in 25" models) (Not recommended for use with Reflective Black Glass Liner)	HTI 3	\$ 489	Y	Y
				Y	14
				Y	Y
Liner Kit					
Glass Liner					
LINER-BK-30	Reflective Black Glass Liner 30" traditional units	HTI 3	\$ 529	Y	Y
				Y	14
				Y	Y
Refractory Upgrade					
Fiber Refractory					
BRICKMI30TB	Traditional 30" Brick interior panels - Tavern Brown	MAJ 3	\$ 289	Y	Y
				Y	14
				Y	Y
BRICKMI30CR	Traditional 30" Brick interior panels - Cottage Red	MAJ 3	\$ 289	Y	Y
				Y	28
				Y	Y
Control, remotes, wall switches					
IntelliFire app					
IFT-WFM	IntelliFire Wi-Fi Module that works with the IntelliFire iOS and Android app. Use to control all the features of your fireplace via a smart device. An RC400, RC450 or RC150 is required for thermostat control	HTI 1	\$ 219	Y	Y
				Y	Y
				Y	Y
Remote/Wall Switch/Wall Thermostat					
IFT-RC150	IntelliFire Touch white wireless wall switch (on/off, cold climate, battery strength indicator)	HTI 1	\$ 116	Y	14
				14	Y
				Y	Y
Touch Screen Remote					
IFT-RC400	IntelliFire Touch black remote control, docking station and auxiliary control module (on/off, flame height, thermostat mode, fan control, child lock, cold climate, timer mode, hot indicator, lights, on-screen maintenance and troubleshooting notifications)	HTI 1	\$ 379	Y	Y
				Y	Y
				Y	Y



IntelliFire app

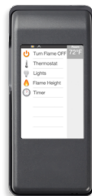

Touch Screen Remote

Venting Notes
 SLP Pipe. Appliance ship with SLP starting collar. DuraVent pipe, purchase STOVEDV-BK starting collar. ICC pipe, purchase STOVEICC-BK adapter.

Trilliant Freestanding 30"

- Includes:
- 22,890 - 32,700 BTU/Hour Input (NG)
 - 22,400 - 32,000 BTU/Hour Input (LP)
 - IntelliFire Touch Ignition System
 - RC400 Remote Control
 - GFK-160A Variable Fan
 - Heat Exchanger Tubes
 - Accent Lights
 - Canyon Brown Brick Interior
 - Decorative Base
 - Ceramic Glass
 - Glowing Embers
 - Battery Back Up
 - Electrical Cord - 10' 3" Left
 - Gas Flex Connector
 - LP Conversion Kit



- Required to Complete - Sold Separately:
- INFIT-30-BK
 - ADP-CK30
 - CK-30

		Disc. Code	MSRP USD	004 IA	010 PA	014 CA	016 NC	EXP
TRILLIANT30IN	Trilliant medium 30" direct vent gas insert with intellifire touch ignition system (NG)	MAJ 3	\$ 3,219	Y	Y	Y	14	N

Fronts - Non-Operable (Required to Complete)

Inside Fit

INFIT-30-BK	Inside fit 30" screen front - Black	HTI 3	\$ 359	Y	Y	Y	14	Y
-------------	-------------------------------------	-------	--------	---	---	---	----	---



Inside Fit

Cabinet (Required to Complete)

Cabinet - Steel

CK-30	Steel cabinet with pedestal base for use with 30" gas inserts	HTI 3	\$ 999	Y	Y	Y	14	N
-------	---------------------------------------------------------------	-------	--------	---	---	---	----	---

Venting (Required to Complete)

Adaptor

ADP-CK30	Adapter kit (required for use with CK-30)	HTI 3	\$ 210	Y	Y	Y	14	Y
----------	-------------------------------------------	-------	--------	---	---	---	----	---

Liner Kit

Glass Liner

LINER-BK-30	Reflective Black Glass Liner 30" traditional units	HTI 3	\$ 529	Y	Y	Y	14	Y
-------------	----------------------------------------------------	-------	--------	---	---	---	----	---

Control, remotes, wall switches

IntelliFire app

IFT-WFM	IntelliFire Wi-Fi Module that works with the IntelliFire iOS and Android app. Use to control all the features of your fireplace via a smart device. An RC400, RC450 or RC150 is required for thermostat control	HTI 1	\$ 219	Y	Y	Y	Y	Y
---------	-----------------------------------------------------------------------------------------------------------------------------------------------------------------------------------------------------------------	-------	--------	---	---	---	---	---

Remote/Wall Switch/Wall Thermostat

IFT-RC150	IntelliFire Touch white wireless wall switch (on/off, cold climate, battery strength indicator)	HTI 1	\$	116	Y	14	14	Y	Y
-----------	-------------------------------------------------------------------------------------------------	-------	----	-----	---	----	----	---	---

Touch Screen Remote

IFT-RC400	IntelliFire Touch black remote control, docking station and auxiliary control module (on/off, flame height, thermostat mode, fan control, child lock, cold climate, timer mode, hot indicator, lights, on-screen maintenance and troubleshooting notifications)	HTI 1	\$	379	Y	Y	Y	Y	Y
-----------	-----------------------------------------------------------------------------------------------------------------------------------------------------------------------------------------------------------------------------------------------------------------	-------	----	-----	---	---	---	---	---



IntelliFire app

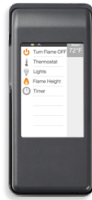

Touch Screen Remote

Venting Notes

SLP Pipe. Appliance ship with SLP starting collar. DuraVent pipe, purchase STOVEDV-BK starting collar. ICC pipe, purchase STOVEICC-BK adapter.

<h1>Majestic</h1>	<h2>Fireplace - Gas - Multi-Sided</h2>	Stocked Item/Lead Time 004=Mt. Pleasant RDC 010=Kutztown RDC 014=Sacramento RDC 016=Charlotte RDC EXP=Factory Expedite Program
-------------------	----------------------------------------	---------------------------------------------------------------------------------------------------------------------------------------------------

Page printed 2/1/2024 3:05:35 PM CST
 Future pricing effective for shipments on or after 03/31/2024
 * Please Contact Who You Purchase This Through for MSRP Pricing

Prices in USD

Non-stock and custom product cannot be cancelled.
 Customer is responsible for freight for orders made outside of assigned RDC facility.

Echelon II 36ST

- Includes:
- 17,500 - 30,000 Btu/Hour Input (NG)
 - 15,000 - 27,000 Btu/Hour Input (LP)
 - Clear LED dimmable lights
 - RC400 remote control
 - Battery backup
 - Ceramic glass
 - Standard bronze glass media
 - IntelliFire Touch ignition system
 - If changing media, follow required number of bags below:
 - -- > Crushed Glass: 3 bags of glass
 - -- > Natural stones: 2 bags of stone
 - -- > Log set & stones: 1 bag of stone



Required to Complete - Sold Separately: • 2 Fronts

		Disc.	MSRP	004	010	014	016	EXP
		Code	USD	IA	PA	CA	NC	
ECHEL36STIN-C	Echelon II 36" see-through top direct vent fireplace with IntelliFire Touch Ignition System (NG)	MAJ 1	\$ 6,159	14	14	14	14	N

Fronts - Non-Operable (Required to Complete)

Clean Face Trim

CFT-36-BK-C	Clean face trim - Black	HTI 1	\$ 429	Y	Y	Y	Y	Y
CFT-36-BZ-C	Clean face trim - Bronze	HTI 1	\$ 479	14	14	14	14	Y
CFT-36-PT-C	Clean face trim - Pewter	MAJ 1	\$ 479	14	14	14	14	Y

Picture Frame Front

PFF-36-CH-C	Picture frame front - Charcoal	MAJ 1	\$ 739	14	14	14	14	Y
-------------	--------------------------------	-------	--------	----	----	----	----	---



Clean Face Trim



Picture Frame Front

Conversion Kit

Conversion Kits

LPK-ECHEL36	CONVERSION KITS, LP	MAJ 1	\$ 99	14	21	14	14	Y
-------------	---------------------	-------	-------	----	----	----	----	---

Gas Logs - Log Set Option										
Driftwood Log Set										
LOGS-DRTWOOD-36	Driftwood log set	MAJ 1	\$ 389	Y	14	14	14	14	Y	
Media										
Media										
GLASS-SP	Glass, Sapphire (1 bag)	MAJ 1	\$ 71	Y	Y	14	14	Y		
GLASS-OY	Glass, Onyx (1 bag)	MAJ 1	\$ 71	Y	Y	14	Y	Y		
GLASS-DM	Glass, Diamond (1 bag)	MAJ 1	\$ 71	Y	Y	14	Y	Y		
GLASS-BZ	Glass, Bronze (1 bag)	MAJ 1	\$ 71	Y	21	14	14	Y		
Stones										
STONES-NATURAL	Natural stones (1 bag)	HTI 1	\$ 111	Y	Y	Y	Y	Y		
Liner Kit										
Black Glass Liner Kit - ST										
BGK-LINEARST	Reflective black ceramic glass liner kit	HTI 1	\$ 439	14	21	14	14	Y		
Options & Accessories										
Options & Accessories										
ST36-CFP	Light baffle kit. Recommended for use when two CFT fronts are being installed.	HTI 1	\$ 99	14	21	14	14	Y		
Heat Management										
Heat Management										
PH-FRT	Passive Heat kit for front or top discharge	HTI 1	\$ 169	Y	Y	Y	Y	Y		
PHTRIM-36C	Vent trim for front discharge (Requires PH-FRT Passive Heat Kit)	HTI 1	\$ 219	14	14	14	14	Y		
PH-SIDE	Passive Heat kit for side discharge (includes 2 side registers)	HTI 1	\$ 239	Y	Y	Y	Y	Y		
Heat Management - Ducted										
PHTRIM-MCE-36	Ducted vent trim for front discharge using ducted Passive Heat (PHFR-MCE-36)	HTI 1	\$ 239	14	14	14	14	Y		
PHSI-MCE	Ducted Passive Heat kit for side discharge (includes duct and 2 side registers)	HTI 1	\$ 549	14	21	14	14	Y		
PHFR-MCE-36	Ducted Passive Heat kit for front discharge (requires PHTRIM-MCE-36 front trim)	HTI 1	\$ 609	14	14	14	14	Y		
Heat Out Kit										
HEAT-OUT-GAS	Heat out kit (includes termination cap, 25' of 6" round duct, fireplace adapter, damper, wall switch and 350CFM fan at termination)	HTI 1	\$ 1,489	Y	14	Y	14	Y		
Heat Zone Kit										
HZLIN-ADP	Heat Zone adaptor, must order for using HEAT-ZONE-GAS	HTI 1	\$ 169	Y	Y	Y	14	Y		
HEAT-ZONE-GAS	Heat-Zone Kit includes fan, 20' of 6" round duct, vent, wall adapter & on/off control. Wire Plug Assembly 26D0619 required if controlling w/RC400 remote. Used in IFT units with ACM & not a GFK fan. Compatible for up to 2 HEAT-ZONE-GAS kits. See manual.	HTI 1	\$ 549	Y	Y	Y	Y	Y		
Control, remotes, wall switches										
Battery Back Up										
BATTERY-WSK	Battery backup wall switch kit for units with IFT control systems. Includes: On/Off Wall Switch, USB-C Port, Battery Backup, Cover Plate, 12' Wire Harness	HTI 1	\$ 179	Y	14	14	14	Y		

IntelliFire app								
IFT-WFM	IntelliFire Wi-Fi Module that works with the IntelliFire iOS and Android app. Use to control all the features of your fireplace via a smart device. An RC400, RC450 or RC150 is required for thermostat control	HTI 1	\$ 219	Y	Y	Y	Y	Y
Remote/Wall Switch/Wall Thermostat								
IFT-RC150	IntelliFire Touch white wireless wall switch (on/off, cold climate, battery strength indicator)	HTI 1	\$ 116	Y	14	14	Y	Y
Touch Screen Remote								
IFT-RC400	IntelliFire Touch black remote control, docking station and auxiliary control module (on/off, flame height, thermostat mode, fan control, child lock, cold climate, timer mode, hot indicator, lights, on-screen maintenance and troubleshooting notifications)	HTI 1	\$ 379	Y	Y	Y	Y	Y



Battery Back Up



IntelliFire app

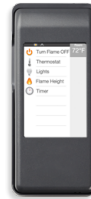

Touch Screen Remote

Venting

Brick Extension Kit

HEAT-OUT-BEK	Exterior Heat-Zone brick extension kit	HTI 1	\$ 71	8	21	21	14	Y
--------------	----------------------------------------	-------	-------	---	----	----	----	---

Venting Notes

Requires 8" DVP pipe. Must have a 18" minimum vertical before attaching a 90 degree elbow to the unit. See venting section of manual.

Approved for use with PVL-PSLP, PVI-SLP-B and PVV-SLP with power vent wire harness (order separately) and IFT-RC400 remote. See venting section of manual.

Echelon II 48ST

Includes:

- 21,000 - 40,000 Btu/Hour Input (NG)
- 20,000 - 34,000 Btu/Hour Input (LP)
- Clear LED dimmable lights
- RC400 remote control
- Battery backup
- Ceramic glass
- Standard with bronze glass media
- IntelliFire Touch ignition system
- Not available for sale in Rhode Island
- If changing media, follow required number of bags below:
 - -- > Crushed Glass: 4 bags of glass
 - -- > Natural stones: 3 bags of stone
 - -- > Log set & stones: 1 bag of stone



Required to Complete - Sold Separately: • 2 Fronts

		Disc. Code	MSRP USD	004 IA	010 PA	014 CA	016 NC	EXP
ECHEL48STIN-C	Echelon II 48" see-through top direct vent fireplace with IntelliFire Touch Ignition System (NG)	MAJ 1	\$ 7,479	14	14	14	14	N

Fronts - Non-Operable (Required to Complete)

Clean Face Trim

CFT-48-BK-C	Clean face trim - Black	HTI 1	\$ 459	Y	Y	Y	Y	Y
CFT-48-BZ-C	Clean face trim - Bronze	HTI 1	\$ 499	14	14	14	14	Y
CFT-48-PT-C	Clean face trim - Pewter	MAJ 1	\$ 499	14	14	14	14	Y

Picture Frame Front

PFF-48-CH-C	Picture frame front - Charcoal	MAJ 1	\$ 839	14	14	14	14	Y
-------------	--------------------------------	-------	--------	----	----	----	----	---



Clean Face Trim



Picture Frame Front

Conversion Kit

Conversion Kits

LPK-ECHEL48	CONVERSION KIT, LP	MAJ 1	\$ 99	28	21	14	14	Y
-------------	--------------------	-------	-------	----	----	----	----	---

Gas Logs - Log Set Option

Driftwood Log Set

LOGS-DRTWOOD-48	Driftwood log set	MAJ 1	\$ 509	Y	Y	14	14	Y
-----------------	-------------------	-------	--------	---	---	----	----	---

Media

Media

GLASS-SP	Glass, Sapphire (1 bag)	MAJ 1	\$ 71	Y	Y	14	14	Y
GLASS-BZ	Glass, Bronze (1 bag)	MAJ 1	\$ 71	Y	21	14	14	Y
GLASS-DM	Glass, Diamond (1 bag)	MAJ 1	\$ 71	Y	Y	14	Y	Y
GLASS-OY	Glass, Onyx (1 bag)	MAJ 1	\$ 71	Y	Y	14	Y	Y

Stones										
STONES-NATURAL	Natural stones (1 bag)	HTI 1	\$	111	Y	Y	Y	Y	Y	Y
Liner Kit										
Black Glass Liner Kit - ST										
BGK-LINEARST	Reflective black ceramic glass liner kit	HTI 1	\$	439	14	21	14	14	14	Y
Options & Accessories										
Options & Accessories										
ST48-CFP	Light baffle kit. Recommended for use when two CFT fronts are being installed.	HTI 1	\$	99	14	21	14	14	14	Y
Heat Management										
Heat Management										
PH-FRT	Passive Heat kit for front or top discharge	HTI 1	\$	169	Y	Y	Y	Y	Y	Y
PHTRIM-48C	Vent trim for front discharge (Requires PH-FRT Passive Heat Kit)	HTI 1	\$	219	Y	Y	Y	Y	Y	Y
PH-SIDE	Passive Heat kit for side discharge (includes 2 side registers)	HTI 1	\$	239	Y	Y	Y	Y	Y	Y
Heat Management - Ducted										
PHTRIM-MCE-48	Ducted vent trim for front discharge using ducted Passive Heat (PHFR-MCE-48)	HTI 1	\$	259	14	14	14	Y	N	
PHSI-MCE	Ducted Passive Heat kit for side discharge (includes duct and 2 side registers)	HTI 1	\$	549	14	21	14	14	Y	
PHFR-MCE-48	Ducted Passive Heat kit for front discharge (requires PHTRIM-MCE-48 front trim)	HTI 1	\$	669	14	14	Y	Y	Y	
Heat Out Kit										
HEAT-OUT-GAS	Heat out kit (includes termination cap, 25' of 6" round duct, fireplace adapter, damper, wall switch and 350CFM fan at termination)	HTI 1	\$	1,489	Y	14	Y	14	Y	
Heat Zone Kit										
HZLIN-ADP	Heat Zone adaptor, must order for using HEAT-ZONE-GAS	HTI 1	\$	169	Y	Y	Y	14	Y	
HEAT-ZONE-GAS	Heat-Zone Kit includes fan, 20' of 6" round duct, vent, wall adapter & on/off control. Wire Plug Assembly 26D0619 required if controlling w/RC400 remote. Used in IFT units with ACM & not a GFK fan. Compatible for up to 2 HEAT-ZONE-GAS kits. See manual.	HTI 1	\$	549	Y	Y	Y	Y	Y	
Control, remotes, wall switches										
Battery Back Up										
BATTERY-WSK	Battery backup wall switch kit for units with IFT control systems. Includes: On/Off Wall Switch, USB-C Port, Battery Backup, Cover Plate, 12' Wire Harness	HTI 1	\$	179	Y	14	14	14	Y	
IntelliFire app										
IFT-WFM	IntelliFire Wi-Fi Module that works with the IntelliFire iOS and Android app. Use to control all the features of your fireplace via a smart device. An RC400, RC450 or RC150 is required for thermostat control	HTI 1	\$	219	Y	Y	Y	Y	Y	
Remote/Wall Switch/Wall Thermostat										
IFT-RC150	IntelliFire Touch white wireless wall switch (on/off, cold climate, battery strength indicator)	HTI 1	\$	116	Y	14	14	Y	Y	
Touch Screen Remote										
IFT-RC400	IntelliFire Touch black remote control, docking station and auxiliary control module (on/off, flame height, thermostat mode, fan control, child lock, cold climate, timer mode, hot indicator, lights, on-screen maintenance and troubleshooting notifications)	HTI 1	\$	379	Y	Y	Y	Y	Y	



Battery Back Up



IntelliFire app

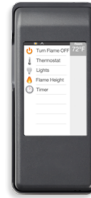

Touch Screen Remote

Venting

Brick Extension Kit

HEAT-OUT-BEK	Exterior Heat-Zone brick extension kit	HTI 1	\$	71	8	21	21	14	Y
--------------	----------------------------------------	-------	----	----	---	----	----	----	---

Venting Notes

Requires 8" DVP pipe. Must have 30" minimum vertical vent before attaching a 90 degree elbow to unit. See venting section of manual.

Approved for use with PVLP-SLP, PVI-SLP-B and PVV-SLP with power vent wire harness (order separately) and IFT-RC400 remote. See venting section of manual.

Marquis II See-Through 42

Includes:

- 43,000 - 57,500 Btu/Hour Input (NG)
- 39,000 - 52,000 Btu/Hour Input (LP)
- RC400 touchscreen remote
- LED accent lighting
- LED illuminated embers
- ClearView ceramic glass
- 11 ceramic fiber split logs
- Gas flex connector
- Junction box
- Intellifire Touch ignition



Required to Complete - Sold Separately: • Two Fronts • Brick Panels

		Disc. Code	MSRP USD	004 IA	010 PA	014 CA	016 NC	EXP
MARQ42STIN	Marquis II 42" see-through- top, direct vent fireplace with IntelliFire Touch ignition (NG)	MAJ 1	\$ 9,069	14	14	14	14	N

Fronts - Non-Operable (Required to Complete)

Firescreens

FSMQ42STCH	Firescreen front 42ST - Charcoal	MAJ 1	\$ 749	14	14	14	14	Y
FSMQ42STPT	Firescreen front 42ST - Pewter	MAJ 1	\$ 789	14	14	14	21	Y
FSMQ42STBZ	Firescreen front 42ST - Bronze	MAJ 1	\$ 789	14	14	14	21	Y

Refractory (Required to Complete)

Refractory

BRICKMQ42STCR	Brick interior panels ST42 - Cottage Red	MAJ 1	\$ 949	77	84	84	84	Y
BRICKMQ42STTB	Brick interior panels ST42 - Tavern Brown	MAJ 1	\$ 949	Y	28	28	35	Y

Conversion Kit

Conversion Kits

LPKMARQ42ST	LP conversion kit	HTI 1	\$ 99		21	14	14	Y
-------------	-------------------	-------	-------	--	----	----	----	---

Heat Management

Heat Out Kit

HEAT-OUT-GAS	Heat out kit (includes termination cap, 25' of 6" round duct, fireplace adapter, damper, wall switch and 350CFM fan at termination)	HTI 1	\$ 1,489	Y	14	Y	14	Y
--------------	-------------------------------------------------------------------------------------------------------------------------------------	-------	----------	---	----	---	----	---

Heat Zone Kit

HEAT-ZONE-GAS	Heat-Zone Kit includes fan, 20' of 6" round duct, vent, wall adapter & on/off control. Wire Plug Assembly 26D0619 required if controlling w/RC400 remote. Used in IFT units with ACM & not a GFK fan. Compatible for up to 2 HEAT-ZONE-GAS kits. See manual.	HTI 1	\$ 549	Y	Y	Y	Y	Y
---------------	--------------------------------------------------------------------------------------------------------------------------------------------------------------------------------------------------------------------------------------------------------------	-------	--------	---	---	---	---	---

Control, remotes, wall switches

Battery Back Up

BATTERY-WSK	Battery backup wall switch kit for units with IFT control systems. Includes: On/Off Wall Switch, USB-C Port, Battery Backup, Cover Plate, 12' Wire Harness	HTI 1	\$ 179	Y	14	14	14	Y
-------------	------------------------------------------------------------------------------------------------------------------------------------------------------------	-------	--------	---	----	----	----	---

IntelliFire app					
IFT-WFM	IntelliFire Wi-Fi Module that works with the IntelliFire iOS and Android app. Use to control all the features of your fireplace via a smart device. An RC400, RC450 or RC150 is required for thermostat control	HTI 1	\$ 219	Y	Y

IntelliFire Touch Controls - Aux Module					
IFT-ACM	IntelliFire Touch AUX Module. Must order if adding Fan, Lights or Power Vent and want to use the IFT-WFM. Do not need to order if using IFT-RC400 (includes IFT-ACM).	HTI 1	\$ 96	14	Y

Touch Screen Remote					
IFT-RC400	IntelliFire Touch black remote control, docking station and auxiliary control module (on/off, flame height, thermostat mode, fan control, child lock, cold climate, timer mode, hot indicator, lights, on-screen maintenance and troubleshooting notifications)	HTI 1	\$ 379	Y	Y



Battery Back Up



IntelliFire app

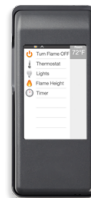

Touch Screen Remote

Venting					
Brick Extension Kit					
HEAT-OUT-BEK	Exterior Heat-Zone brick extension kit	HTI 1	\$ 71	8	21

Venting Notes					
Requires 8" DVP pipe. Must have a 24" minimum vertical vent before attaching a 90° elbow to unit. See Venting section.					
Approved for use with PVL P-SLP, PVI-SLP-B and PVV-SLP with power vent wire harness (order separately). See venting section of manual.					

Majestic Fireplace - Wood - Single-Sided

Stocked Item/Lead Time
 004=Mt. Pleasant RDC
 010=Kutztown RDC
 014=Sacramento RDC
 016=Charlotte RDC
 EXP=Factory Expedite Program

Prices in USD

Page printed 2/1/2024 3:05:35 PM CST
 Future pricing effective for shipments on or after 03/31/2024
 * Please Contact Who You Purchase This Through for MSRP Pricing

Non-stock and custom product cannot be cancelled.

Customer is responsible for freight for orders made outside of assigned RDC facility.

Ashland 36

Includes:

- 36" x 38" Opening
 - Radiant Heat
 - Outside Air Standard
 - Dual gas Knockouts
 - Steel Grate
 - Safety Firescreen
 - UL Listed
 - Attic insulation shield
- When ordering Firebrick Yellow molded brick panels, SRV4059-693 is recommended for matching hearth



Required to Complete - Sold Separately: • Firebrick • Flex Venting for Outside Air

		Disc. Code	MSRP USD	004 IA	010 PA	014 CA	016 NC	EXP
ASH36	36" Radiant Wood Burning Fireplace with Natural Gray Hearth Refractory	MAJ 1	\$ 3,159	8	14	14	14	N

Refractory (Required to Complete)

Herringbone

MMHB36-B	Firebrick Yellow Molded brick panels - herringbone	HTI 1	\$ 1,319	8	21	14	14	N
----------	----------------------------------------------------	-------	----------	---	----	----	----	---

Refractory

AMMTB36	Natural Gray Molded brick panels - Traditional	HTI 1	\$ 979	14	14	14	Y	N
AMMHB36	Natural Gray Molded brick panels - Herringbone	HTI 1	\$ 1,319	14	14	14	14	N

Traditional

MMTB36-B	Firebrick Yellow Molded brick panels - traditional	HTI 1	\$ 979	8	21	14	14	N
----------	----------------------------------------------------	-------	--------	---	----	----	----	---

Glass Doors - Operable

Glass Bi-Fold Door

DFG4036BK	Glass bi-fold door, black	HTI 1	\$ 1,649	8	21	14	14	N
-----------	---------------------------	-------	----------	---	----	----	----	---



Glass Bi-Fold Door

Brick Panels										
Herringbone Refractory Extension										
MMHBX-B	Firebrick Yellow Herringbone brick refractory extensions	HTI 1	\$ 169	8	21	21	21	N		
Traditional Refractory Extension										
MMTBX-B	Firebrick Yellow Traditional brick refractory extensions	HTI 1	\$ 169	8	21	21	21	Y		
Mortar										
Refractory Mortar										
MMMORTR	10 lbs. Mortar (TRAD: 1 required, HERR: 2 required)	HTI 1	\$ 94	Y	Y	Y	Y	N		
Options & Accessories										
Options & Accessories										
AMMTBX	Natural Gray Traditional brick refractory extensions	HTI 1	\$ 145	8	21	14	14	Y		
AMMHBX	Natural Gray Herringbone brick refractory extensions	HTI 1	\$ 145	8	21	14	14	Y		
Floor Protector (HP)										
Micore Hearth Extension - Hearth Extension										
HX4M	Hearth extension for 42" models (70"x 20"x 1/2") - pack of 5	HTI 1	\$ 329	Y	Y	Y	Y	N		
Venting										
Insulated Flex Duct - Chimney Air Kits/Flex Duct										
ID6	6" (152mm) insulated flex duct for use with outside air kit - includes two 42" (1065mm) sections	HTI 1	\$ 95	Y	Y	Y	Y	Y		
Uninsulated Flex Duct - Chimney Air Kits/Flex Duct										
UD6	6" (152mm) uninsulated flex duct for use with outside air kit - includes two 42" (1065mm) sections	HTI 1	\$ 67	Y	21	14	14	Y		
SL400 Series Pipe - Term Kits & Acc - Sng Pk - Chimney Air Kits/Flex Duct										
CAK5A	Chimney air kit for SL1100 and SL400 series pipe (required in Canada)	HTI 1	\$ 135	Y	Y	14	14	Y		
Venting Notes										
Outside air kit standard										
Uses SL1100 series chimney										
Attic insulation shield standard										
Model not approved for use in Canada										

Ashland 42

Includes:

- 42" x 38" Opening
 - Radiant Heat
 - Outside Air Standard
 - Dual gas Knockouts
 - Steel Grate
 - Safety Firescreen
 - UL Listed
 - Attic insulation shield
- When ordering Firebrick Yellow molded brick panels, SRV4059-695 is recommended for matching hearth



Required to Complete - Sold Separately: • Firebrick • Flex Venting for Outside Air

		Disc. Code	MSRP USD	004 IA	010 PA	014 CA	016 NC	EXP
ASH42	42" Radiant Wood Burning Fireplace with Natural Gray Hearth Refractory	MAJ 1	\$ 3,649	Y	14	14	Y	N

Refractory (Required to Complete)

Herringbone

MMHB42-B	Firebrick Yellow Molded brick panels - herringbone	HTI 1	\$ 1,459	8	21	21	14	N
----------	----------------------------------------------------	-------	----------	---	----	----	----	---

Refractory

AMMTB42	Natural Gray Molded brick panels - traditional	HTI 1	\$ 1,099	Y	Y	Y	Y	N
AMMHB42	Natural Gray Molded brick panels - herringbone	HTI 1	\$ 1,459	Y	Y	Y	Y	N

Traditional

MMTB42-B	Firebrick Yellow Molded brick panels - traditional	HTI 1	\$ 1,099	8	21	21	14	N
----------	----------------------------------------------------	-------	----------	---	----	----	----	---

Glass Doors - Operable

Glass Bi-Fold Door

DFG4042BK	Glass bi-fold door - Black	HTI 1	\$ 2,049	28	28	28	28	N
-----------	----------------------------	-------	----------	----	----	----	----	---



Glass Bi-Fold Door

Gas Logs - Log Set Option

Duzy Series Gas Log Sets To be used with VDY burner/grate assembly only

VDY24/18D2A	4-piece Fiber Ceramic log set for VDY24/18. 18" rear log for narrow back fireplaces.	HTI 3	\$ 349	Y	Y	21	Y	Y
VDY24/18D3R	6-piece Refractory Cement log set for VDY24/18. 18" rear log for narrow back fireplaces.	HTI 3	\$ 419	Y	Y	14	Y	N
VDY30D2A	4-piece Fiber Ceramic log set for VDY30.	HTI 3	\$ 419	14	14	21	14	N
VDY24/18D5	8-piece Fiber Ceramic log set for VDY24/18. 18" rear log for narrow back fireplaces.	HTI 3	\$ 479	Y	Y	21	Y	Y
VDY30D3R	6-piece Refractory Cement log set for VDY30.	HTI 3	\$ 479	Y	21	14	14	Y
VDY30D5	8-piece Fiber Ceramic log set for VDY30.	HTI 3	\$ 589	14	14	21	14	Y

Fireside Grand Oak Gas Log Sets

GO324-IPI-LP-HK	24" IPI Grand Oak LP Burner/Hearth Kit - 3 Tier	HTI 3	\$ 1,449	Y	21	21	21	Y
GO324-IPI-NG-HK	24" IPI Grand Oak NG Burner/Hearth Kit - 3 Tier	HTI 3	\$ 1,449	Y	14	14	14	N

Grand Oak Logs 324

GO324	24" Grand Oak Log Set - 11pcs, 3 Tier	HTI 3	\$ 599	Y	14	14	Y	N
-------	---------------------------------------	-------	--------	---	----	----	---	---



Duzy Series Gas Log Sets



Fireside Grand Oak Gas Log Sets

Gas Logs - Burner Option

Millivolt Control

VDY24/18PVP	24"/18" Vented Natural Flame On/Off Control Burner Assembly. L.P. 50,000 Btu.	HTI 3	\$ 969	Y	Y	35	Y	Y
VDY24/18NVP	24"/18" Vented Natural Flame On/Off Control Burner Assembly. N.G. 50,000 Btu.	HTI 3	\$ 969	Y	35	35	Y	Y
VDY30PVP	30" Vented Natural Flame On/Off Control Burner Assembly. L.P. 65,000 Btu.	HTI 3	\$ 1,059	Y	35	35	35	Y
VDY30NVP	30" Vented Natural Flame On/Off Control Burner Assembly. N.G. 65,000 Btu.	HTI 3	\$ 1,059	Y	Y	35	Y	Y

Brick Panels

Herringbone Refractory Extension

MMHBX-B	Firebrick Yellow Herringbone brick refractory extensions	HTI 1	\$ 169	8	21	21	21	N
---------	----------------------------------------------------------	-------	--------	---	----	----	----	---

Traditional Refractory Extension

MMTBX-B	Firebrick Yellow Traditional brick refractory extensions	HTI 1	\$ 169	8	21	21	21	Y
---------	----------------------------------------------------------	-------	--------	---	----	----	----	---

Mortar

Refractory Mortar

MMMORTR	10 lbs. Mortar (TRAD: 1 required, HERR: 2 required)	HTI 1	\$ 94	Y	Y	Y	Y	N
---------	-----------------------------------------------------	-------	-------	---	---	---	---	---

Options & Accessories										
Options & Accessories										
AMMTBX	Natural Gray Traditional brick refractory extensions	HTI 1	\$	145	8	21	14	14	Y	
AMMHBX	Natural Gray Herringbone brick refractory extensions	HTI 1	\$	145	8	21	14	14	Y	
Floor Protector (HP)										
Micore Hearth Extension - Hearth Extension										
HX4M	Hearth extension for 42" models (70"x 20"x 1/2") - pack of 5	HTI 1	\$	329	Y	Y	Y	Y	N	
Venting										
Insulated Flex Duct - Chimney Air Kits/Flex Duct										
ID6	6" (152mm) insulated flex duct for use with outside air kit - includes two 42" (1065mm) sections	HTI 1	\$	95	Y	Y	Y	Y	Y	
Uninsulated Flex Duct - Chimney Air Kits/Flex Duct										
UD6	6" (152mm) uninsulated flex duct for use with outside air kit - includes two 42" (1065mm) sections	HTI 1	\$	67	Y	21	14	14	Y	
SL1100 Wood Pipe - Single Pack - Chimney Air Kits/Flex Duct Dimensions: 11" Inner / 13" Outer										
CAK8A	Chimney air kit (For use with BIR42 and RUTHERFORD-42, ODCASTLEWD-42)	HTI 1	\$	145	Y	Y	14	14	Y	
Venting Notes										
Outside air kit standard										
Uses SL1100 series chimney										
Attic insulation shield standard										
Model not approved for use in Canada										

Ashland 50

Includes:

- 50" x 38" Opening
- Radiant Heat
- Outside Air Standard
- Dual gas Knockouts
- Steel Grate
- Safety Firescreen
- UL Listed
- When ordering Firebrick Yellow molded brick panels, SRV4059-697 is recommended for matching hearth



- Required to Complete - Sold Separately:
- Firebrick
 - See Venting notes
 - Advanced Install Product training required before product ships
 - Flex Venting for Outside Air

		Disc. Code	MSRP USD	004 IA	010 PA	014 CA	016 NC	EXP
ASH50	50" Radiant Wood Burning Fireplace with Natural Gray Hearth Refractory	MAJ 1	\$ 4,379	8	14	14	14	N

Refractory (Required to Complete)

Herringbone

MMHB50-B	Firebrick Yellow Molded brick panels - herringbone	HTI 1	\$ 1,849	8	14	14	14	N
----------	----------------------------------------------------	-------	----------	---	----	----	----	---

Refractory

AMMTB50	Natural Gray Molded brick panels - Traditional	HTI 1	\$ 1,499	14	14	14	14	N
AMMHB50	Natural Gray Molded brick panels - Herringbone	HTI 1	\$ 1,849	14	14	14	Y	N

Traditional

MMTB50-B	Firebrick Yellow Molded brick panels - traditional	HTI 1	\$ 1,499	8	21	14	14	N
----------	----------------------------------------------------	-------	----------	---	----	----	----	---

Glass Doors - Operable

Glass Bi-Fold Door

DFG4050BK	Glass bi-fold door - Black	HTI 1	\$ 2,169	8	21	14	14	N
-----------	----------------------------	-------	----------	---	----	----	----	---



Glass Bi-Fold Door

Brick Panels

Herringbone Refractory Extension

MMHBX-B	Firebrick Yellow Herringbone brick refractory extensions	HTI 1	\$ 169	8	21	21	21	N
---------	----------------------------------------------------------	-------	--------	---	----	----	----	---

Traditional Refractory Extension

MMTBX-B	Firebrick Yellow Traditional brick refractory extensions	HTI 1	\$ 169	8	21	21	21	Y
---------	----------------------------------------------------------	-------	--------	---	----	----	----	---

Mortar									
Refractory Mortar									
MMMORTR	10 lbs. Mortar (TRAD: 1 required, HERR: 2 required)	HTI 1	\$	94	Y	Y	Y	Y	N

Options & Accessories									
Options & Accessories									
AMMHBX	Natural Gray Herringbone brick refractory extensions	HTI 1	\$	145	8	21	14	14	Y
AMMTBX	Natural Gray Traditional brick refractory extensions	HTI 1	\$	145	8	21	14	14	Y

Floor Protector (HP)									
Micore Hearth Extension - Hearth Extension									
HX4M	Hearth extension for 42" models (70"x 20"x 1/2") - pack of 5	HTI 1	\$	329	Y	Y	Y	Y	N

Venting									
Insulated Flex Duct - Chimney Air Kits/Flex Duct									
ID6	6" (152mm) insulated flex duct for use with outside air kit - includes two 42" (1065mm) sections	HTI 1	\$	95	Y	Y	Y	Y	Y

Uninsulated Flex Duct - Chimney Air Kits/Flex Duct									
UD6	6" (152mm) uninsulated flex duct for use with outside air kit - includes two 42" (1065mm) sections	HTI 1	\$	67	Y	21	14	14	Y

Venting Notes									
Outside air kit standard									
Requires 14" Dura-Vent DuraChimney II. See venting section.									
Must order Attic Insulation Shield (14DCA-IS), Roof Radiation Shields (14DCA-RRS), Chase Top Collar (14DCA-CTC). See Venting Section.									
Model not approved for use in Canada									

Biltmore 36

Includes:

- Full refractory lining in traditional or herringbone pattern
- Powder coat finish
- Safety firescreen
- Dual gas knockouts
- Steel grate
- Outside air kit
- Attic insulation shield
- UL/ULC Listed



Required to Complete - Sold Separately: • Flex Venting for Outside Air

		Disc. Code	MSRP USD	004 IA	010 PA	014 CA	016 NC	EXP
SB60	36" Radiant Wood Burning Fireplace	MAJ 1	\$ 2,149	Y	Y	14	Y	N
SB60HB	36" Radiant Wood Burning Fireplace w/herringbone brick pattern	MAJ 1	\$ 2,209	Y	Y	14	Y	N

Glass Doors - Operable

Glass Bi-Fold Door

DM6036	Original bi-fold glass doors with black trim	HTI 1	\$ 559	Y	Y	Y	Y	Y
--------	----------------------------------------------	-------	--------	---	---	---	---	---



Glass Bi-Fold Door

Mesh Doors - Operable

Grand Vista 60

GV60BK	Grand Vista cabinet style mesh doors - Black	HTI 1	\$ 1,219	8	21	14	14	N
--------	----------------------------------------------	-------	----------	---	----	----	----	---



Grand Vista 60

Gas Logs - Log Set Option**Campfire Gas Log Sets**

CFL-18LP-C	18" Campfire fiber gas log set with Stainless Steel Burner and hearth kit - 60,000 Btu/Hour Input (LP).	HTI 3	\$ 1,009	14	21	14	14	Y
CFL-18NG-C	18" Campfire fiber gas log set with Stainless Steel Burner and hearth kit - 60,000 Btu/Hour Input (NG).	HTI 3	\$ 1,009	14	14	14	14	Y
CFL-24LP-C	24" Campfire fiber gas log set with Stainless Steel Burner and hearth kit - 60,000 Btu/Hour Input (LP)	HTI 3	\$ 1,079	14	21	14	14	N
CFL-24NG-C	24" Campfire fiber gas log set with Stainless Steel Burner and hearth kit - 60,000 Btu/Hour Input (NG)	HTI 3	\$ 1,079	14	14	14	14	Y
CFL-24NG-IPI	24" Campfire fiber gas log set with Stainless Steel Burner and hearth kit, IPI ignition - 60,000 Btu/Hour Input (NG)	HTI 3	\$ 1,179	14	21	14	14	Y
CFL-24LP-IPI	24" Campfire fiber gas log set with Stainless Steel Burner and hearth kit, IPI ignition - 60,000 Btu/Hour Input (LP)	HTI 3	\$ 1,179	14	21	14	14	Y

Duzy Series Gas Log Sets To be used with VDY burner/grate assembly only

VDY24/18D2A	4-piece Fiber Ceramic log set for VDY24/18. 18" rear log for narrow back fireplaces.	HTI 3	\$ 349	Y	Y	21	Y	Y
VDY24/18D3R	6-piece Refractory Cement log set for VDY24/18. 18" rear log for narrow back fireplaces.	HTI 3	\$ 419	Y	Y	14	Y	N
VDY30D2A	4-piece Fiber Ceramic log set for VDY30.	HTI 3	\$ 419	14	14	21	14	N
VDY24/18D5	8-piece Fiber Ceramic log set for VDY24/18. 18" rear log for narrow back fireplaces.	HTI 3	\$ 479	Y	Y	21	Y	Y
VDY30D3R	6-piece Refractory Cement log set for VDY30.	HTI 3	\$ 479	Y	21	14	14	Y
VDY30D5	8-piece Fiber Ceramic log set for VDY30.	HTI 3	\$ 589	14	14	21	14	Y

Fireside Grand Oak Gas Log Sets

GO24MTCH-HK	24" Match Light Grand Oak Burner/Hearth Kit - 2 Tier	HTI 3	\$ 999	Y	21	14	21	Y
GO24-IPI-LP-HK	24" IPI Grand Oak LP Burner/Hearth Kit - 2 Tier	HTI 3	\$ 1,289	Y	21	21	21	Y
GO24-IPI-NG-HK	24" IPI Grand Oak NG Burner/Hearth Kit - 2 Tier	HTI 3	\$ 1,289	Y	14	14	Y	Y
GO318-IPI-LP-HK	18" IPI Grand Oak LP Burner/Hearth Kit - 3 Tier	HTI 3	\$ 1,359	21	21	21	21	Y
GO318-IPI-NG-HK	18" IPI Grand Oak NG Burner/Hearth Kit - 3 Tier	HTI 3	\$ 1,359	Y	21	14	21	Y

Fireside Realwood Gas Log Sets

FRW118	18" Fireside Realwood refractory cement log set (order hearth kit separately)	HTI 3	\$ 189	Y	21	Y	21	N
FRW124	24" Fireside Realwood refractory cement log set (order hearth kit separately)	HTI 3	\$ 229	Y	14	Y	Y	N

Fireside Supreme Oak Gas Logs

FSO18	18" Fireside Supreme Oak refractory cement log set (order hearth kit separately)	HTI 3	\$ 489	Y	14	14	21	N
FSO24	24" Fireside Supreme Oak refractory cement log set (order hearth kit separately)	HTI 3	\$ 529	Y	14	21	21	N

Grand Oak Logs 24

GO24	24" Grand Oak Log Set - 11pcs, 2 Tier	HTI 3	\$ 429	Y	Y	14	Y	N
------	---------------------------------------	-------	--------	---	---	----	---	---

Grand Oak Logs 318

GO318	18" Grand Oak Log Set - 10pcs, 3 Tier	HTI 3	\$ 589	Y	21	14	21	N
-------	---------------------------------------	-------	--------	---	----	----	----	---



Campfire Gas Log Sets



Duzy Series Gas Log Sets



Fireside Grand Oak Gas Log Sets



Fireside Realwood Gas Log Sets



Fireside Supreme Oak Gas Logs

Gas Logs - Burner Option										
Match Light Hearth Kit										
MHK18NG	Hearth Kits Sand Pan Burners for Single-Sided Fireplaces 18" matchlight hearth kit - 60,000 Btu/Hour Input (NG only)	HTI 3	\$ 259	Y	28	Y	28	N		
MHK24NG	Hearth Kits Sand Pan Burners for Single-Sided Fireplaces 24" matchlight hearth kit - 74,000 Btu/Hour Input (NG only)	HTI 3	\$ 319	Y	14	Y	21	N		
Millivolt Control										
VDY24/18PVP	24"/18" Vented Natural Flame On/Off Control Burner Assembly. L.P. 50,000 Btu.	HTI 3	\$ 969	Y	Y	35	Y	Y		
VDY24/18NVP	24"/18" Vented Natural Flame On/Off Control Burner Assembly. N.G. 50,000 Btu.	HTI 3	\$ 969	Y	35	35	Y	Y		
VDY30PVP	30" Vented Natural Flame On/Off Control Burner Assembly. L.P. 65,000 Btu.	HTI 3	\$ 1,059	Y	35	35	35	Y		
VDY30NVP	30" Vented Natural Flame On/Off Control Burner Assembly. N.G. 65,000 Btu.	HTI 3	\$ 1,059	Y	Y	35	Y	Y		
Safety Pilot Hearth Kit										
SP18LP	Hearth Kits Sand Pan Burners for Single-Sided Fireplaces 18" safety pilot hearth kit - 40,000 Btu/Hour Input (LP)	HTI 3	\$ 499	Y	14	14	21	N		
SP18NG	Hearth Kits Sand Pan Burners for Single-Sided Fireplaces 18" safety pilot hearth kit - 60,000 Btu/Hour Input (NG)	HTI 3	\$ 499	Y	14	14	14	N		
Floor Protector (HP)										
Micore Hearth Extension - Hearth Extension										
HX4M	Hearth extension for 42" models (70"x 20"x 1/2") - pack of 5	HTI 1	\$ 329	Y	Y	Y	Y	N		
Venting										
Insulated Flex Duct - Chimney Air Kits/Flex Duct										
ID4	4" (100mm) insulated flex duct for outside air - includes two 42" (1065mm) sections	HTI 1	\$ 82	Y	Y	14	Y	Y		
Uninsulated Flex Duct - Chimney Air Kits/Flex Duct										
UD4	4" (100mm) uninsulated flex duct for outside air - includes two 42" (1065mm) sections	HTI 1	\$ 53	Y	Y	Y	Y	Y		
SL400 Series Pipe - Term Kits & Acc - Sng Pk - Chimney Air Kits/Flex Duct										
CAK5A	Chimney air kit for SL1100 and SL400 series pipe (required in Canada)	HTI 1	\$ 135	Y	Y	14	14	Y		

Venting Notes

Outside air kit standard

U.S. uses SL1100 series chimney. Canada uses SL400 series chimney and requires SLA-10

Attic insulation shield standard

Biltmore 42

Includes:

- Full refractory lining in traditional or herringbone pattern
- Powder coat finish
- Safety firescreen
- Dual gas knockouts
- Steel grate
- Outside air kit
- Attic insulation shield
- UL/ULC Listed



Required to Complete - Sold Separately: • Flex Venting for Outside Air

		Disc. Code	MSRP USD	004 IA	010 PA	014 CA	016 NC	EXP
SB80	42" Radiant Wood Burning Fireplace	MAJ 1	\$ 2,879	Y	Y	Y	Y	N
SB80HB	42" Radiant Wood Burning Fireplace w/herringbone brick pattern	MAJ 1	\$ 2,939	Y	Y	14	Y	N

Glass Doors - Operable

Glass Bi-Fold Door

DM8042	Original bi-fold glass doors with black trim	HTI 1	\$ 709	Y	Y	Y	Y	Y
--------	----------------------------------------------	-------	--------	---	---	---	---	---



Glass Bi-Fold Door

Mesh Doors - Operable

Grand Vista 80

GV80BK	Grand Vista cabinet style mesh doors - Black	HTI 1	\$ 1,379	Y	14	14	14	N
--------	----------------------------------------------	-------	----------	---	----	----	----	---



Grand Vista 80

Gas Logs - Log Set Option**Campfire Gas Log Sets**

CFL-18LP-C	18" Campfire fiber gas log set with Stainless Steel Burner and hearth kit - 60,000 Btu/Hour Input (LP).	HTI 3	\$ 1,009	14	21	14	14	Y
CFL-18NG-C	18" Campfire fiber gas log set with Stainless Steel Burner and hearth kit - 60,000 Btu/Hour Input (NG).	HTI 3	\$ 1,009	14	14	14	14	Y
CFL-24NG-C	24" Campfire fiber gas log set with Stainless Steel Burner and hearth kit - 60,000 Btu/Hour Input (NG)	HTI 3	\$ 1,079	14	14	14	14	Y
CFL-24LP-C	24" Campfire fiber gas log set with Stainless Steel Burner and hearth kit - 60,000 Btu/Hour Input (LP)	HTI 3	\$ 1,079	14	21	14	14	N
CFL-30LP-C	30" Campfire fiber gas log set with Stainless Steel Burner and hearth kit - 60,000 Btu/Hour Input (LP)	HTI 3	\$ 1,159	14	21	14	14	N
CFL-30NG-C	30" Campfire fiber gas log set with Stainless Steel Burner and hearth kit - 60,000 Btu/Hour Input (NG)	HTI 3	\$ 1,159	14	21	14	14	Y
CFL-24NG-IPI	24" Campfire fiber gas log set with Stainless Steel Burner and hearth kit, IPI ignition - 60,000 Btu/Hour Input (NG)	HTI 3	\$ 1,179	14	21	14	14	Y
CFL-24LP-IPI	24" Campfire fiber gas log set with Stainless Steel Burner and hearth kit, IPI ignition - 60,000 Btu/Hour Input (LP)	HTI 3	\$ 1,179	14	21	14	14	Y

Duzy Series Gas Log Sets To be used with VDY burner/grate assembly only

VDY24/18D2A	4-piece Fiber Ceramic log set for VDY24/18. 18" rear log for narrow back fireplaces.	HTI 3	\$ 349	Y	Y	21	Y	Y
VDY24/18D3R	6-piece Refractory Cement log set for VDY24/18. 18" rear log for narrow back fireplaces.	HTI 3	\$ 419	Y	Y	14	Y	N
VDY30D2A	4-piece Fiber Ceramic log set for VDY30.	HTI 3	\$ 419	14	14	21	14	N
VDY24/18D5	8-piece Fiber Ceramic log set for VDY24/18. 18" rear log for narrow back fireplaces.	HTI 3	\$ 479	Y	Y	21	Y	Y
VDY30D3R	6-piece Refractory Cement log set for VDY30.	HTI 3	\$ 479	Y	21	14	14	Y
VDY30D5	8-piece Fiber Ceramic log set for VDY30.	HTI 3	\$ 589	14	14	21	14	Y

Fireside Grand Oak Gas Log Sets

GO24MTCH-HK	24" Match Light Grand Oak Burner/Hearth Kit - 2 Tier	HTI 3	\$ 999	Y	21	14	21	Y
GO30MTCH-HK	30" Match Light Grand Oak Burner/Hearth Kit - 2 Tier	HTI 3	\$ 999	Y	14	14	21	N
GO24-IPI-NG-HK	24" IPI Grand Oak NG Burner/Hearth Kit - 2 Tier	HTI 3	\$ 1,289	Y	14	14	Y	Y
GO24-IPI-LP-HK	24" IPI Grand Oak LP Burner/Hearth Kit - 2 Tier	HTI 3	\$ 1,289	Y	21	21	21	Y
GO30-IPI-LP-HK	30" IPI Grand Oak LP Burner/Hearth Kit - 2 Tier	HTI 3	\$ 1,329	Y	21	14	14	Y
GO30-IPI-NG-HK	30" IPI Grand Oak NG Burner/Hearth Kit - 2 Tier	HTI 3	\$ 1,329	Y	14	14	14	N
GO324-IPI-NG-HK	24" IPI Grand Oak NG Burner/Hearth Kit - 3 Tier	HTI 3	\$ 1,449	Y	14	14	14	N
GO324-IPI-LP-HK	24" IPI Grand Oak LP Burner/Hearth Kit - 3 Tier	HTI 3	\$ 1,449	Y	21	21	21	Y

Fireside Realwood Gas Log Sets

FRW118	18" Fireside Realwood refractory cement log set (order hearth kit separately)	HTI 3	\$ 189	Y	21	Y	21	N
FRW124	24" Fireside Realwood refractory cement log set (order hearth kit separately)	HTI 3	\$ 229	Y	14	Y	Y	N

Fireside Supreme Oak Gas Logs

FSO18	18" Fireside Supreme Oak refractory cement log set (order hearth kit separately)	HTI 3	\$ 489	Y	14	14	21	N
FSO24	24" Fireside Supreme Oak refractory cement log set (order hearth kit separately)	HTI 3	\$ 529	Y	14	21	21	N
FSO30	30" Fireside Supreme Oak refractory cement log set (order hearth kit separately)	HTI 3	\$ 569	Y	14	14	21	N

Grand Oak Logs 24

GO24	24" Grand Oak Log Set - 11pcs, 2 Tier	HTI 3	\$ 429	Y	Y	14	Y	N
GO30	30" Grand Oak Log Set - 12pcs, 2 Tier	HTI 3	\$ 519	Y	21	14	Y	N

Grand Oak Logs 324

GO324	24" Grand Oak Log Set - 11pcs, 3 Tier	HTI 3	\$ 599	Y	14	14	Y	N
-------	---------------------------------------	-------	--------	---	----	----	---	---



Campfire Gas Log Sets



Duzy Series Gas Log Sets



Fireside Grand Oak Gas Log Sets



Fireside Realwood Gas Log Sets



Fireside Supreme Oak Gas Logs

Gas Logs - Burner Option

Match Light Hearth Kit

MHK18NG	Hearth Kits Sand Pan Burners for Single-Sided Fireplaces 18" matchlight hearth kit - 60,000 Btu/Hour Input (NG only)	HTI 3	\$ 259	Y	28	Y	28	N
MHK24NG	Hearth Kits Sand Pan Burners for Single-Sided Fireplaces 24" matchlight hearth kit - 74,000 Btu/Hour Input (NG only)	HTI 3	\$ 319	Y	14	Y	21	N

Millivolt Control

VDY24/18NVP	24"/18" Vented Natural Flame On/Off Control Burner Assembly. N.G. 50,000 Btu.	HTI 3	\$ 969	Y	35	35	Y	Y
VDY24/18PVP	24"/18" Vented Natural Flame On/Off Control Burner Assembly. L.P. 50,000 Btu.	HTI 3	\$ 969	Y	Y	35	Y	Y
VDY30NVP	30" Vented Natural Flame On/Off Control Burner Assembly. N.G. 65,000 Btu.	HTI 3	\$ 1,059	Y	Y	35	Y	Y
VDY30PVP	30" Vented Natural Flame On/Off Control Burner Assembly. L.P. 65,000 Btu.	HTI 3	\$ 1,059	Y	35	35	35	Y

Safety Pilot Hearth Kit

SP18LP	Hearth Kits Sand Pan Burners for Single-Sided Fireplaces 18" safety pilot hearth kit - 40,000 Btu/Hour Input (LP)	HTI 3	\$ 499	Y	14	14	21	N
SP18NG	Hearth Kits Sand Pan Burners for Single-Sided Fireplaces 18" safety pilot hearth kit - 60,000 Btu/Hour Input (NG)	HTI 3	\$ 499	Y	14	14	14	N
SP24NG	Hearth Kits Sand Pan Burners for Single-Sided Fireplaces 24" safety pilot hearth kit - 67,000 Btu/Hour Input (NG)	HTI 3	\$ 509	Y	14	14	Y	N
SP24LP	Hearth Kits Sand Pan Burners for Single-Sided Fireplaces 24" safety pilot hearth kit - 40,000 Btu/Hour Input (LP)	HTI 3	\$ 509	Y	14	14	21	N
SP30NG	30" safety pilot hearth kit - 80,000 Btu/Hour Input (NG)	HTI 3	\$ 529	21	21	21	21	N
SP30LP	30" safety pilot hearth kit - 60,000 Btu/Hour Input (LP)	HTI 3	\$ 529	21	21	21	14	N

Floor Protector (HP)									
Micore Hearth Extension - Hearth Extension									
HX4M	Hearth extension for 42" models (70"x 20"x 1/2") - pack of 5	HTI 1	\$	329	Y	Y	Y	Y	N
Venting									
Insulated Flex Duct - Chimney Air Kits/Flex Duct									
ID4	4" (100mm) insulated flex duct for outside air - includes two 42" (1065mm) sections	HTI 1	\$	82	Y	Y	14	Y	Y
Uninsulated Flex Duct - Chimney Air Kits/Flex Duct									
UD4	4" (100mm) uninsulated flex duct for outside air - includes two 42" (1065mm) sections	HTI 1	\$	53	Y	Y	Y	Y	Y
SL400 Series Pipe - Term Kits & Acc - Sng Pk - Chimney Air Kits/Flex Duct									
CAK5A	Chimney air kit for SL1100 and SL400 series pipe (required in Canada)	HTI 1	\$	135	Y	Y	14	14	Y
Venting Notes									
Outside air kit standard									
U.S. uses SL1100 series chimney. Canada uses SL400 series chimney and requires SLA-10									
Attic insulation shield standard									

Biltmore 50

Includes:

- Full refractory lining in traditional or herringbone pattern
- Powder coat finish
- Safety firescreen
- Dual gas knockouts
- Steel grate
- Outside air kit
- Attic insulation shield
- UL Listed



Required to Complete - Sold Separately: • Flex Venting for Outside Air

		Disc. Code	MSRP USD	004 IA	010 PA	014 CA	016 NC	EXP
SB100	50" Radiant Wood Burning Fireplace	MAJ 1	\$ 4,169	Y	14	14	Y	N
SB100HB	50" Radiant Wood Burning Fireplace w/herringbone brick pattern	MAJ 1	\$ 4,229	Y	Y	14	Y	N

Glass Doors - Operable

Glass Bi-Fold Door

DM100	Original bi-fold glass doors with black trim	HTI 1	\$ 1,449	Y	14	14	14	N
-------	----------------------------------------------	-------	----------	---	----	----	----	---



Glass Bi-Fold Door

Mesh Doors - Operable

Grand Vista 100

GV100BK	Grand Vista cabinet style mesh doors - Black	HTI 1	\$ 1,819	8	21	14	14	N
---------	----------------------------------------------	-------	----------	---	----	----	----	---



Grand Vista 100

Gas Logs - Log Set Option**Campfire Gas Log Sets**

CFL-18NG-C	18" Campfire fiber gas log set with Stainless Steel Burner and hearth kit - 60,000 Btu/Hour Input (NG).	HTI 3	\$ 1,009	14	14	14	14	Y
CFL-18LP-C	18" Campfire fiber gas log set with Stainless Steel Burner and hearth kit - 60,000 Btu/Hour Input (LP).	HTI 3	\$ 1,009	14	21	14	14	Y
CFL-24LP-C	24" Campfire fiber gas log set with Stainless Steel Burner and hearth kit - 60,000 Btu/Hour Input (LP)	HTI 3	\$ 1,079	14	21	14	14	N
CFL-24NG-C	24" Campfire fiber gas log set with Stainless Steel Burner and hearth kit - 60,000 Btu/Hour Input (NG)	HTI 3	\$ 1,079	14	14	14	14	Y
CFL-30LP-C	30" Campfire fiber gas log set with Stainless Steel Burner and hearth kit - 60,000 Btu/Hour Input (LP)	HTI 3	\$ 1,159	14	21	14	14	N
CFL-30NG-C	30" Campfire fiber gas log set with Stainless Steel Burner and hearth kit - 60,000 Btu/Hour Input (NG)	HTI 3	\$ 1,159	14	21	14	14	Y
CFL-24LP-IPI	24" Campfire fiber gas log set with Stainless Steel Burner and hearth kit, IPI ignition - 60,000 Btu/Hour Input (LP)	HTI 3	\$ 1,179	14	21	14	14	Y
CFL-24NG-IPI	24" Campfire fiber gas log set with Stainless Steel Burner and hearth kit, IPI ignition - 60,000 Btu/Hour Input (NG)	HTI 3	\$ 1,179	14	21	14	14	Y

Duzy Series Gas Log Sets To be used with VDY burner/grate assembly only

VDY24/18D2A	4-piece Fiber Ceramic log set for VDY24/18. 18" rear log for narrow back fireplaces.	HTI 3	\$ 349	Y	Y	21	Y	Y
VDY30D2A	4-piece Fiber Ceramic log set for VDY30.	HTI 3	\$ 419	14	14	21	14	N
VDY24/18D3R	6-piece Refractory Cement log set for VDY24/18. 18" rear log for narrow back fireplaces.	HTI 3	\$ 419	Y	Y	14	Y	N
VDY24/18D5	8-piece Fiber Ceramic log set for VDY24/18. 18" rear log for narrow back fireplaces.	HTI 3	\$ 479	Y	Y	21	Y	Y
VDY30D3R	6-piece Refractory Cement log set for VDY30.	HTI 3	\$ 479	Y	21	14	14	Y
VDY30D5	8-piece Fiber Ceramic log set for VDY30.	HTI 3	\$ 589	14	14	21	14	Y

Fireside Grand Oak Gas Log Sets

GO30MTCH-HK	30" Match Light Grand Oak Burner/Hearth Kit - 2 Tier	HTI 3	\$ 999	Y	14	14	21	N
GO24MTCH-HK	24" Match Light Grand Oak Burner/Hearth Kit - 2 Tier	HTI 3	\$ 999	Y	21	14	21	Y
GO24-IPI-LP-HK	24" IPI Grand Oak LP Burner/Hearth Kit - 2 Tier	HTI 3	\$ 1,289	Y	21	21	21	Y
GO24-IPI-NG-HK	24" IPI Grand Oak NG Burner/Hearth Kit - 2 Tier	HTI 3	\$ 1,289	Y	14	14	Y	Y
GO30-IPI-NG-HK	30" IPI Grand Oak NG Burner/Hearth Kit - 2 Tier	HTI 3	\$ 1,329	Y	14	14	14	N
GO30-IPI-LP-HK	30" IPI Grand Oak LP Burner/Hearth Kit - 2 Tier	HTI 3	\$ 1,329	Y	21	14	14	Y
GO330-IPI-NG-HK	30" IPI Grand Oak NG Burner/Hearth Kit - 3 Tier	HTI 3	\$ 1,499	Y	21	21	14	N
GO330-IPI-LP-HK	30" IPI Grand Oak LP Burner/Hearth Kit - 3 Tier	HTI 3	\$ 1,499	Y	21	14	14	N

Fireside Realwood Gas Log Sets

FRW118	18" Fireside Realwood refractory cement log set (order hearth kit separately)	HTI 3	\$ 189	Y	21	Y	21	N
FRW124	24" Fireside Realwood refractory cement log set (order hearth kit separately)	HTI 3	\$ 229	Y	14	Y	Y	N

Fireside Supreme Oak Gas Logs

FSO18	18" Fireside Supreme Oak refractory cement log set (order hearth kit separately)	HTI 3	\$ 489	Y	14	14	21	N
FSO24	24" Fireside Supreme Oak refractory cement log set (order hearth kit separately)	HTI 3	\$ 529	Y	14	21	21	N
FSO30	30" Fireside Supreme Oak refractory cement log set (order hearth kit separately)	HTI 3	\$ 569	Y	14	14	21	N

Grand Oak Logs 24

GO24	24" Grand Oak Log Set - 11pcs, 2 Tier	HTI 3	\$ 429	Y	Y	14	Y	N
GO30	30" Grand Oak Log Set - 12pcs, 2 Tier	HTI 3	\$ 519	Y	21	14	Y	N

Grand Oak Logs 330

GO330	30" Grand Oak Log Set - 12pcs, 3 Tier	HTI 3	\$ 669	Y	21	14	21	N
-------	---------------------------------------	-------	--------	---	----	----	----	---



Campfire Gas Log Sets



Duzy Series Gas Log Sets



Fireside Grand Oak Gas Log Sets



Fireside Realwood Gas Log Sets



Fireside Supreme Oak Gas Logs

Gas Logs - Burner Option

Match Light Hearth Kit

MHK18NG	Hearth Kits Sand Pan Burners for Single-Sided Fireplaces 18" matchlight hearth kit - 60,000 Btu/Hour Input (NG only)	HTI 3	\$ 259	Y	28	Y	28	N
MHK24NG	Hearth Kits Sand Pan Burners for Single-Sided Fireplaces 24" matchlight hearth kit - 74,000 Btu/Hour Input (NG only)	HTI 3	\$ 319	Y	14	Y	21	N

Millivolt Control

VDY24/18PVP	24"/18" Vented Natural Flame On/Off Control Burner Assembly. L.P. 50,000 Btu.	HTI 3	\$ 969	Y	Y	35	Y	Y
VDY24/18NVP	24"/18" Vented Natural Flame On/Off Control Burner Assembly. N.G. 50,000 Btu.	HTI 3	\$ 969	Y	35	35	Y	Y
VDY30NVP	30" Vented Natural Flame On/Off Control Burner Assembly. N.G. 65,000 Btu.	HTI 3	\$ 1,059	Y	Y	35	Y	Y
VDY30PVP	30" Vented Natural Flame On/Off Control Burner Assembly. L.P. 65,000 Btu.	HTI 3	\$ 1,059	Y	35	35	35	Y

Safety Pilot Hearth Kit

SP18LP	Hearth Kits Sand Pan Burners for Single-Sided Fireplaces 18" safety pilot hearth kit - 40,000 Btu/Hour Input (LP)	HTI 3	\$ 499	Y	14	14	21	N
SP18NG	Hearth Kits Sand Pan Burners for Single-Sided Fireplaces 18" safety pilot hearth kit - 60,000 Btu/Hour Input (NG)	HTI 3	\$ 499	Y	14	14	14	N
SP24NG	Hearth Kits Sand Pan Burners for Single-Sided Fireplaces 24" safety pilot hearth kit - 67,000 Btu/Hour Input (NG)	HTI 3	\$ 509	Y	14	14	Y	N
SP24LP	Hearth Kits Sand Pan Burners for Single-Sided Fireplaces 24" safety pilot hearth kit - 40,000 Btu/Hour Input (LP)	HTI 3	\$ 509	Y	14	14	21	N
SP30NG	30" safety pilot hearth kit - 80,000 Btu/Hour Input (NG)	HTI 3	\$ 529	21	21	21	21	N
SP30LP	30" safety pilot hearth kit - 60,000 Btu/Hour Input (LP)	HTI 3	\$ 529	21	21	21	14	N

Floor Protector (HP)

Micore Hearth Extension - Hearth Extension

HX4M	Hearth extension for 42" models (70"x 20"x 1/2") - pack of 5	HTI 1	\$	329	Y	Y	Y	Y	N
------	--------------------------------------------------------------	-------	----	-----	---	---	---	---	---

Venting

Insulated Flex Duct - Chimney Air Kits/Flex Duct

ID4	4" (100mm) insulated flex duct for outside air - includes two 42" (1065mm) sections	HTI 1	\$	82	Y	Y	14	Y	Y
-----	-------------------------------------------------------------------------------------	-------	----	----	---	---	----	---	---

Uninsulated Flex Duct - Chimney Air Kits/Flex Duct

UD4	4" (100mm) uninsulated flex duct for outside air - includes two 42" (1065mm) sections	HTI 1	\$	53	Y	Y	Y	Y	Y
-----	---------------------------------------------------------------------------------------	-------	----	----	---	---	---	---	---

SL400 Series Pipe - Term Kits & Acc - Sng Pk - Chimney Air Kits/Flex Duct

CAK5A	Chimney air kit for SL1100 and SL400 series pipe (required in Canada)	HTI 1	\$	135	Y	Y	14	14	Y
-------	-----------------------------------------------------------------------	-------	----	-----	---	---	----	----	---

Venting Notes

Outside air kit standard
Uses SL1100 series chimney
Attic insulation shield standard
Model not approved for use in Canada

Royalton 36

Includes:

- Front access damper handle
- Ash lip
- Safety firescreen
- Traditional refractory lining
- Dual gas knockouts (Note: Not approved for vent free logs)
- Steel grate
- Attic insulation shield
- UL/ULC listed



No additional items required to complete.

		Disc.	MSRP	004	010	014	016	EXP
		Code	USD	IA	PA	CA	NC	
BE36	36" Radiant Wood Burning Fireplace	MAJ 1	\$ 1,239	Y	Y	Y	Y	N

Glass Doors - Operable

Glass Bi-Fold Door

DM1036	Original bi-fold glass doors with black trim	HTI 1	\$ 519	Y	Y	Y	Y	Y
DM1036S	Original bi-fold glass doors with stainless steel trim	HTI 1	\$ 569	8	21	14	14	Y



Glass Bi-Fold Door

Gas Logs - Log Set Option

Duzy Series Gas Log Sets To be used with VDY burner/grate assembly only

VDY24/18D2A	4-piece Fiber Ceramic log set for VDY24/18. 18" rear log for narrow back fireplaces.	HTI 3	\$ 349	Y	Y	21	Y	Y
VDY30D2A	4-piece Fiber Ceramic log set for VDY30.	HTI 3	\$ 419	14	14	21	14	N
VDY24/18D3R	6-piece Refractory Cement log set for VDY24/18. 18" rear log for narrow back fireplaces.	HTI 3	\$ 419	Y	Y	14	Y	N
VDY24/18D5	8-piece Fiber Ceramic log set for VDY24/18. 18" rear log for narrow back fireplaces.	HTI 3	\$ 479	Y	Y	21	Y	Y
VDY30D3R	6-piece Refractory Cement log set for VDY30.	HTI 3	\$ 479	Y	21	14	14	Y
VDY30D5	8-piece Fiber Ceramic log set for VDY30.	HTI 3	\$ 589	14	14	21	14	Y

Fireside Realwood Gas Log Sets

FRW118	18" Fireside Realwood refractory cement log set (order hearth kit separately)	HTI 3	\$ 189	Y	21	Y	21	N
FRW124	24" Fireside Realwood refractory cement log set (order hearth kit separately)	HTI 3	\$ 229	Y	14	Y	Y	N

Fireside Supreme Oak Gas Logs					
FSO18	18" Fireside Supreme Oak refractory cement log set (order hearth kit separately)	HTI 3	\$	489	Y 14 14 21 N
FSO24	24" Fireside Supreme Oak refractory cement log set (order hearth kit separately)	HTI 3	\$	529	Y 14 21 21 N



Duzy Series Gas Log Sets



Fireside Realwood Gas Log Sets



Fireside Supreme Oak Gas Logs

Gas Logs - Burner Option

Match Light Hearth Kit

MHK18NG	Hearth Kits Sand Pan Burners for Single-Sided Fireplaces 18" matchlight hearth kit - 60,000 Btu/Hour Input (NG only)	HTI 3	\$	259	Y 28 Y 28 N
MHK24NG	Hearth Kits Sand Pan Burners for Single-Sided Fireplaces 24" matchlight hearth kit - 74,000 Btu/Hour Input (NG only)	HTI 3	\$	319	Y 14 Y 21 N

Millivolt Control

VDY24/18NVP	24"/18" Vented Natural Flame On/Off Control Burner Assembly. N.G. 50,000 Btu.	HTI 3	\$	969	Y 35 35 Y Y
VDY24/18PVP	24"/18" Vented Natural Flame On/Off Control Burner Assembly. L.P. 50,000 Btu.	HTI 3	\$	969	Y Y 35 Y Y
VDY30NVP	30" Vented Natural Flame On/Off Control Burner Assembly. N.G. 65,000 Btu.	HTI 3	\$	1,059	Y Y 35 Y Y
VDY30PVP	30" Vented Natural Flame On/Off Control Burner Assembly. L.P. 65,000 Btu.	HTI 3	\$	1,059	Y 35 35 35 Y

Safety Pilot Hearth Kit

SP18LP	Hearth Kits Sand Pan Burners for Single-Sided Fireplaces 18" safety pilot hearth kit - 40,000 Btu/Hour Input (LP)	HTI 3	\$	499	Y 14 14 21 N
SP18NG	Hearth Kits Sand Pan Burners for Single-Sided Fireplaces 18" safety pilot hearth kit - 60,000 Btu/Hour Input (NG)	HTI 3	\$	499	Y 14 14 14 N

Options & Accessories

Outside Air Kit

AK24	Outside air kit (1 each) - Flex Venting not included	HTI 1	\$	15	Y Y Y Y Y
------	------------------------------------------------------	-------	----	----	-----------

Floor Protector (HP)

Micore Hearth Extension - Hearth Extension

HX4M	Hearth extension for 42" models (70"x 20"x 1/2") - pack of 5	HTI 1	\$	329	Y Y Y Y N
------	--------------------------------------------------------------	-------	----	-----	-----------

Venting

Insulated Flex Duct - Chimney Air Kits/Flex Duct

ID4	4" (100mm) insulated flex duct for outside air - includes two 42" (1065mm) sections	HTI 1	\$	82	Y Y 14 Y Y
-----	-------------------------------------------------------------------------------------	-------	----	----	------------

Uninsulated Flex Duct - Chimney Air Kits/Flex Duct

UD4	4" (100mm) uninsulated flex duct for outside air - includes two 42" (1065mm) sections	HTI 1	\$	53	Y Y Y Y Y
-----	---------------------------------------------------------------------------------------	-------	----	----	-----------

SL300 Series Pipe - Comp - SngPk - Chimney Air Kits/Flex Duct Dimensions: 8" Inner / 10.5" Outer

CAK4A	Chimney air kit (for SL300 series chimney systems only)	HTI 1	\$	120	Y	Y	14	14	Y
-------	---------------------------------------------------------	-------	----	-----	---	---	----	----	---

Venting Notes

Uses SL300 series chimney

Attic insulation shield standard

Royalton 42

Includes:

- Front access damper handle
- Ash lip
- Safety firescreen
- Traditional refractory lining
- Dual gas knockouts (Note: Not approved for vent free logs)
- Steel grate
- Attic insulation shield
- UL/ULC listed



No additional items required to complete.

		Disc.	MSRP	004	010	014	016	EXP
		Code	USD	IA	PA	CA	NC	
BE42	42" Radiant Wood Burning Fireplace	MAJ 1	\$ 1,899	Y	Y	Y	Y	N

Glass Doors - Operable

Glass Bi-Fold Door

DM1042	Original bi-fold glass doors with black trim	HTI 1	\$ 649	Y	Y	Y	Y	Y
DM1042S	Original bi-fold glass doors with stainless steel trim	HTI 1	\$ 699	8	21	14	14	Y



Glass Bi-Fold Door

Gas Logs - Log Set Option

Duzy Series Gas Log Sets To be used with VDY burner/grate assembly only

VDY24/18D2A	4-piece Fiber Ceramic log set for VDY24/18. 18" rear log for narrow back fireplaces.	HTI 3	\$ 349	Y	Y	21	Y	Y
VDY24/18D3R	6-piece Refractory Cement log set for VDY24/18. 18" rear log for narrow back fireplaces.	HTI 3	\$ 419	Y	Y	14	Y	N
VDY30D2A	4-piece Fiber Ceramic log set for VDY30.	HTI 3	\$ 419	14	14	21	14	N
VDY24/18D5	8-piece Fiber Ceramic log set for VDY24/18. 18" rear log for narrow back fireplaces.	HTI 3	\$ 479	Y	Y	21	Y	Y
VDY30D3R	6-piece Refractory Cement log set for VDY30.	HTI 3	\$ 479	Y	21	14	14	Y
VDY30D5	8-piece Fiber Ceramic log set for VDY30.	HTI 3	\$ 589	14	14	21	14	Y

Fireside Realwood Gas Log Sets

FRW118	18" Fireside Realwood refractory cement log set (order hearth kit separately)	HTI 3	\$ 189	Y	21	Y	21	N
FRW124	24" Fireside Realwood refractory cement log set (order hearth kit separately)	HTI 3	\$ 229	Y	14	Y	Y	N

Fireside Supreme Oak Gas Logs					
FSO18	18" Fireside Supreme Oak refractory cement log set (order hearth kit separately)	HTI 3	\$	489	Y 14 14 21 N
FSO24	24" Fireside Supreme Oak refractory cement log set (order hearth kit separately)	HTI 3	\$	529	Y 14 21 21 N



Duzy Series Gas Log Sets



Fireside Realwood Gas Log Sets



Fireside Supreme Oak Gas Logs

Gas Logs - Burner Option

Match Light Hearth Kit

MHK18NG	Hearth Kits Sand Pan Burners for Single-Sided Fireplaces 18" matchlight hearth kit - 60,000 Btu/Hour Input (NG only)	HTI 3	\$	259	Y 28 Y 28 N
MHK24NG	Hearth Kits Sand Pan Burners for Single-Sided Fireplaces 24" matchlight hearth kit - 74,000 Btu/Hour Input (NG only)	HTI 3	\$	319	Y 14 Y 21 N

Millivolt Control

VDY24/18NVP	24"/18" Vented Natural Flame On/Off Control Burner Assembly. N.G. 50,000 Btu.	HTI 3	\$	969	Y 35 35 Y Y
VDY24/18PVP	24"/18" Vented Natural Flame On/Off Control Burner Assembly. L.P. 50,000 Btu.	HTI 3	\$	969	Y Y 35 Y Y
VDY30NVP	30" Vented Natural Flame On/Off Control Burner Assembly. N.G. 65,000 Btu.	HTI 3	\$	1,059	Y Y 35 Y Y
VDY30PVP	30" Vented Natural Flame On/Off Control Burner Assembly. L.P. 65,000 Btu.	HTI 3	\$	1,059	Y 35 35 35 Y

Safety Pilot Hearth Kit

SP18LP	Hearth Kits Sand Pan Burners for Single-Sided Fireplaces 18" safety pilot hearth kit - 40,000 Btu/Hour Input (LP)	HTI 3	\$	499	Y 14 14 21 N
SP18NG	Hearth Kits Sand Pan Burners for Single-Sided Fireplaces 18" safety pilot hearth kit - 60,000 Btu/Hour Input (NG)	HTI 3	\$	499	Y 14 14 14 N
SP24LP	Hearth Kits Sand Pan Burners for Single-Sided Fireplaces 24" safety pilot hearth kit - 40,000 Btu/Hour Input (LP)	HTI 3	\$	509	Y 14 14 21 N
SP24NG	Hearth Kits Sand Pan Burners for Single-Sided Fireplaces 24" safety pilot hearth kit - 67,000 Btu/Hour Input (NG)	HTI 3	\$	509	Y 14 14 Y N

Options & Accessories

Outside Air Kit

AK24	Outside air kit (1 each) - Flex Venting not included	HTI 1	\$	15	Y Y Y Y Y
------	------------------------------------------------------	-------	----	----	-----------

Floor Protector (HP)

Micore Hearth Extension - Hearth Extension

HX4M	Hearth extension for 42" models (70"x 20"x 1/2") - pack of 5	HTI 1	\$	329	Y Y Y Y N
------	--------------------------------------------------------------	-------	----	-----	-----------

Venting

Insulated Flex Duct - Chimney Air Kits/Flex Duct

ID4	4" (100mm) insulated flex duct for outside air - includes two 42" (1065mm) sections	HTI 1	\$	82	Y Y 14 Y Y
-----	-------------------------------------------------------------------------------------	-------	----	----	------------

Uninsulated Flex Duct - Chimney Air Kits/Flex Duct

UD4	4" (100mm) uninsulated flex duct for outside air - includes two 42" (1065mm) sections	HTI 1	\$	53	Y	Y	Y	Y	Y
-----	---------------------------------------------------------------------------------------	-------	----	----	---	---	---	---	---

SL300 Series Pipe - Comp - SngPk - Chimney Air Kits/Flex Duct Dimensions: 8" Inner / 10.5" Outer

CAK4A	Chimney air kit (for SL300 series chimney systems only)	HTI 1	\$	120	Y	Y	14	14	Y
-------	---------------------------------------------------------	-------	----	-----	---	---	----	----	---

Venting Notes

Uses SL300 series chimney
Attic insulation shield standard

Sovereign 36

Includes:

- Traditional full refractory lining
- Safety firescreen
- Dual gas knockouts
- Steel grate
- Front access damper handle
- Attic insulation shield
- Ash lip
- UL/ULC Listed



No additional items required to complete.

		Disc. Code	MSRP USD	004 IA	010 PA	014 CA	016 NC	EXP
SA36R	36" Radiant Fireplace	MAJ 1	\$ 1,529	Y	Y	14	Y	N
SA36C	36" Heat Circulating Fireplace	MAJ 1	\$ 1,529	Y	Y	14	Y	N

Glass Doors - Operable

Glass Bi-Fold Door

DM1736	Original bi-fold glass doors with black trim	HTI 1	\$ 559	Y	Y	14	Y	Y
DM1736S	Original bi-fold glass doors with stainless steel trim	HTI 1	\$ 609	8	21	14	14	Y

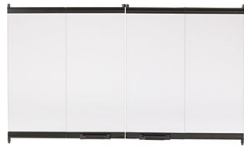

Glass Bi-Fold Door

Glass Doors - Gasketed

Gasketed Glass Door 36 Heat circulating model only

GGD36BK-B	Gasketed glass door, cabinet style, black (not for use on radiant units, circulating units only)	HTI 1	\$ 1,329	Y	14	14	14	Y
-----------	--------------------------------------------------------------------------------------------------	-------	----------	---	----	----	----	---



Gasketed Glass Door 36

Mesh Doors - Operable

Grand Vista 36

GV36BK	Grand Vista cabinet style mesh doors - Black	HTI 1	\$ 1,119	8	21	14	14	N
--------	----------------------------------------------	-------	----------	---	----	----	----	---



Grand Vista 36

Gas Logs - Log Set Option

Campfire Gas Log Sets

CFL-18LP-C	18" Campfire fiber gas log set with Stainless Steel Burner and hearth kit - 60,000 Btu/Hour Input (LP).	HTI 3	\$ 1,009	14	21	14	14	Y
CFL-18NG-C	18" Campfire fiber gas log set with Stainless Steel Burner and hearth kit - 60,000 Btu/Hour Input (NG).	HTI 3	\$ 1,009	14	14	14	14	Y

Duzy Series Gas Log Sets To be used with VDY burner/grate assembly only

VDY24/18D2A	4-piece Fiber Ceramic log set for VDY24/18. 18" rear log for narrow back fireplaces.	HTI 3	\$ 349	Y	Y	21	Y	Y
VDY30D2A	4-piece Fiber Ceramic log set for VDY30.	HTI 3	\$ 419	14	14	21	14	N
VDY24/18D3R	6-piece Refractory Cement log set for VDY24/18. 18" rear log for narrow back fireplaces.	HTI 3	\$ 419	Y	Y	14	Y	N
VDY30D3R	6-piece Refractory Cement log set for VDY30.	HTI 3	\$ 479	Y	21	14	14	Y
VDY24/18D5	8-piece Fiber Ceramic log set for VDY24/18. 18" rear log for narrow back fireplaces.	HTI 3	\$ 479	Y	Y	21	Y	Y
VDY30D5	8-piece Fiber Ceramic log set for VDY30.	HTI 3	\$ 589	14	14	21	14	Y

Fireside Realwood Gas Log Sets

FRW118	18" Fireside Realwood refractory cement log set (order hearth kit separately)	HTI 3	\$ 189	Y	21	Y	21	N
FRW124	24" Fireside Realwood refractory cement log set (order hearth kit separately)	HTI 3	\$ 229	Y	14	Y	Y	N

Fireside Supreme Oak Gas Logs

FSO18	18" Fireside Supreme Oak refractory cement log set (order hearth kit separately)	HTI 3	\$ 489	Y	14	14	21	N
FSO24	24" Fireside Supreme Oak refractory cement log set (order hearth kit separately)	HTI 3	\$ 529	Y	14	21	21	N



Campfire Gas Log Sets



Duzy Series Gas Log Sets



Fireside Realwood Gas Log Sets



Fireside Supreme Oak Gas Logs

Gas Logs - Burner Option

Match Light Hearth Kit

MHK18NG	Hearth Kits Sand Pan Burners for Single-Sided Fireplaces 18" matchlight hearth kit - 60,000 Btu/Hour Input (NG only)	HTI 3	\$ 259	Y	28	Y	28	N
MHK24NG	Hearth Kits Sand Pan Burners for Single-Sided Fireplaces 24" matchlight hearth kit - 74,000 Btu/Hour Input (NG only)	HTI 3	\$ 319	Y	14	Y	21	N

Millivolt Control									
VDY24/18NVP	24"/18" Vented Natural Flame On/Off Control Burner Assembly. N.G. 50,000 Btu.	HTI 3	\$ 969	Y	35	35	Y	Y	
VDY24/18PVP	24"/18" Vented Natural Flame On/Off Control Burner Assembly. L.P. 50,000 Btu.	HTI 3	\$ 969	Y	Y	35	Y	Y	
VDY30NVP	30" Vented Natural Flame On/Off Control Burner Assembly. N.G. 65,000 Btu.	HTI 3	\$ 1,059	Y	Y	35	Y	Y	
VDY30PVP	30" Vented Natural Flame On/Off Control Burner Assembly. L.P. 65,000 Btu.	HTI 3	\$ 1,059	Y	35	35	35	Y	

Safety Pilot Hearth Kit									
SP18LP	Hearth Kits Sand Pan Burners for Single-Sided Fireplaces 18" safety pilot hearth kit - 40,000 Btu/Hour Input (LP)	HTI 3	\$ 499	Y	14	14	21	N	
SP18NG	Hearth Kits Sand Pan Burners for Single-Sided Fireplaces 18" safety pilot hearth kit - 60,000 Btu/Hour Input (NG)	HTI 3	\$ 499	Y	14	14	14	N	

Fans

Blower

FK23	160 CFM fan kit (for use on circulating models only) Kit consists of fan, power cord w/plug (no control incl).	HTI 1	\$ 319	Y	Y	Y	Y	Y	
------	----------------------------------------------------------------------------------------------------------------	-------	--------	---	---	---	---	---	--

Control, remotes, wall switches

Control, remotes, wall switches

SCVS	Variable Speed Control	MAJ 1	\$ 122	Y	Y	14	Y	N	
------	------------------------	-------	--------	---	---	----	---	---	--

Floor Protector (HP)

Micore Hearth Extension - Hearth Extension

HX4M	Hearth extension for 42" models (70"x 20"x 1/2") - pack of 5	HTI 1	\$ 329	Y	Y	Y	Y	N	
------	--------------------------------------------------------------	-------	--------	---	---	---	---	---	--

Venting

Insulated Flex Duct - Chimney Air Kits/Flex Duct

ID4	4" (100mm) insulated flex duct for outside air - includes two 42" (1065mm) sections	HTI 1	\$ 82	Y	Y	14	Y	Y	
-----	-------------------------------------------------------------------------------------	-------	-------	---	---	----	---	---	--

Outside Air Kit

AK22	Outside air kit - (flex not included)	HTI 1	\$ 68	Y	Y	Y	Y	Y	
------	---------------------------------------	-------	-------	---	---	---	---	---	--

Uninsulated Flex Duct - Chimney Air Kits/Flex Duct

UD4	4" (100mm) uninsulated flex duct for outside air - includes two 42" (1065mm) sections	HTI 1	\$ 53	Y	Y	Y	Y	Y	
-----	---------------------------------------------------------------------------------------	-------	-------	---	---	---	---	---	--

SL300 Series Pipe - Comp - SngPk - Chimney Air Kits/Flex Duct Dimensions: 8" Inner / 10.5" Outer

CAK4A	Chimney air kit (for SL300 series chimney systems only)	HTI 1	\$ 120	Y	Y	14	14	Y	
-------	---------------------------------------------------------	-------	--------	---	---	----	----	---	--

Venting Notes

Uses SL300 series chimney
Attic insulation shield standard

Sovereign 42

Includes:

- Traditional full refractory lining
- Safety firescreen
- Dual gas knockouts
- Steel grate
- Front access damper handle
- Attic insulation shield
- Ash lip
- UL/ULC Listed



No additional items required to complete.

		Disc.	MSRP	004	010	014	016	EXP
		Code	USD	IA	PA	CA	NC	
SA42C	42" Heat Circulating Fireplace	MAJ 1	\$ 1,979	Y	14	14	Y	N
SA42R	42" Radiant Fireplace	MAJ 1	\$ 1,979	Y	Y	14	Y	N

Glass Doors - Operable

Glass Bi-Fold Door

DM1742	Original bi-fold glass doors with black trim	HTI 1	\$ 689	Y	Y	14	Y	Y
DM1742S	Original bi-fold glass doors with stainless steel trim	HTI 1	\$ 749	8	21	14	14	Y

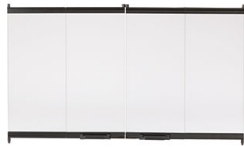

Glass Bi-Fold Door

Glass Doors - Gasketed

Gasketed Glass Door 42 Heat circulating model only

GGD42BK-B	Gasketed glass door, cabinet style, black (not for use on radiant units, circulating units only)	HTI 1	\$ 1,449	Y	14	14	14	Y
-----------	--------------------------------------------------------------------------------------------------	-------	----------	---	----	----	----	---



Gasketed Glass Door 42

Mesh Doors - Operable

Grand Vista 42

GV42BK	Grand Vista cabinet style mesh doors - Black	HTI 1	\$ 1,289	8	21	14	14	N
--------	----------------------------------------------	-------	----------	---	----	----	----	---



Grand Vista 42

Gas Logs - Log Set Option

Campfire Gas Log Sets

CFL-18LP-C	18" Campfire fiber gas log set with Stainless Steel Burner and hearth kit - 60,000 Btu/Hour Input (LP).	HTI 3	\$ 1,009	14	21	14	14	Y
CFL-18NG-C	18" Campfire fiber gas log set with Stainless Steel Burner and hearth kit - 60,000 Btu/Hour Input (NG).	HTI 3	\$ 1,009	14	14	14	14	Y

Duzy Series Gas Log Sets To be used with VDY burner/grate assembly only

VDY24/18D2A	4-piece Fiber Ceramic log set for VDY24/18. 18" rear log for narrow back fireplaces.	HTI 3	\$ 349	Y	Y	21	Y	Y
VDY30D2A	4-piece Fiber Ceramic log set for VDY30.	HTI 3	\$ 419	14	14	21	14	N
VDY24/18D3R	6-piece Refractory Cement log set for VDY24/18. 18" rear log for narrow back fireplaces.	HTI 3	\$ 419	Y	Y	14	Y	N
VDY30D3R	6-piece Refractory Cement log set for VDY30.	HTI 3	\$ 479	Y	21	14	14	Y
VDY24/18D5	8-piece Fiber Ceramic log set for VDY24/18. 18" rear log for narrow back fireplaces.	HTI 3	\$ 479	Y	Y	21	Y	Y
VDY30D5	8-piece Fiber Ceramic log set for VDY30.	HTI 3	\$ 589	14	14	21	14	Y

Fireside Realwood Gas Log Sets

FRW118	18" Fireside Realwood refractory cement log set (order hearth kit separately)	HTI 3	\$ 189	Y	21	Y	21	N
FRW124	24" Fireside Realwood refractory cement log set (order hearth kit separately)	HTI 3	\$ 229	Y	14	Y	Y	N

Fireside Supreme Oak Gas Logs

FSO18	18" Fireside Supreme Oak refractory cement log set (order hearth kit separately)	HTI 3	\$ 489	Y	14	14	21	N
FSO24	24" Fireside Supreme Oak refractory cement log set (order hearth kit separately)	HTI 3	\$ 529	Y	14	21	21	N



Campfire Gas Log Sets



Duzy Series Gas Log Sets



Fireside Realwood Gas Log Sets



Fireside Supreme Oak Gas Logs

Gas Logs - Burner Option

Match Light Hearth Kit

MHK18NG	Hearth Kits Sand Pan Burners for Single-Sided Fireplaces 18" matchlight hearth kit - 60,000 Btu/Hour Input (NG only)	HTI 3	\$ 259	Y	28	Y	28	N
MHK24NG	Hearth Kits Sand Pan Burners for Single-Sided Fireplaces 24" matchlight hearth kit - 74,000 Btu/Hour Input (NG only)	HTI 3	\$ 319	Y	14	Y	21	N

Millivolt Control									
VDY24/18PVP	24"/18" Vented Natural Flame On/Off Control Burner Assembly. L.P. 50,000 Btu.	HTI 3	\$ 969	Y	Y	35	Y	Y	
VDY24/18NVP	24"/18" Vented Natural Flame On/Off Control Burner Assembly. N.G. 50,000 Btu.	HTI 3	\$ 969	Y	35	35	Y	Y	
VDY30PVP	30" Vented Natural Flame On/Off Control Burner Assembly. L.P. 65,000 Btu.	HTI 3	\$ 1,059	Y	35	35	35	Y	
VDY30NVP	30" Vented Natural Flame On/Off Control Burner Assembly. N.G. 65,000 Btu.	HTI 3	\$ 1,059	Y	Y	35	Y	Y	

Safety Pilot Hearth Kit									
SP18LP	Hearth Kits Sand Pan Burners for Single-Sided Fireplaces 18" safety pilot hearth kit - 40,000 Btu/Hour Input (LP)	HTI 3	\$ 499	Y	14	14	21	N	
SP18NG	Hearth Kits Sand Pan Burners for Single-Sided Fireplaces 18" safety pilot hearth kit - 60,000 Btu/Hour Input (NG)	HTI 3	\$ 499	Y	14	14	14	N	
SP24NG	Hearth Kits Sand Pan Burners for Single-Sided Fireplaces 24" safety pilot hearth kit - 67,000 Btu/Hour Input (NG)	HTI 3	\$ 509	Y	14	14	Y	N	
SP24LP	Hearth Kits Sand Pan Burners for Single-Sided Fireplaces 24" safety pilot hearth kit - 40,000 Btu/Hour Input (LP)	HTI 3	\$ 509	Y	14	14	21	N	

Fans

Blower

FK23	160 CFM fan kit (for use on circulating models only) Kit consists of fan, power cord w/plug (no control incl).	HTI 1	\$ 319	Y	Y	Y	Y	Y	
------	----------------------------------------------------------------------------------------------------------------	-------	--------	---	---	---	---	---	--

Control, remotes, wall switches

Control, remotes, wall switches

SCVS	Variable Speed Control	MAJ 1	\$ 122	Y	Y	14	Y	N	
------	------------------------	-------	--------	---	---	----	---	---	--

Floor Protector (HP)

Micore Hearth Extension - Hearth Extension

HX4M	Hearth extension for 42" models (70"x 20"x 1/2") - pack of 5	HTI 1	\$ 329	Y	Y	Y	Y	N	
------	--------------------------------------------------------------	-------	--------	---	---	---	---	---	--

Venting

Insulated Flex Duct - Chimney Air Kits/Flex Duct

ID4	4" (100mm) insulated flex duct for outside air - includes two 42" (1065mm) sections	HTI 1	\$ 82	Y	Y	14	Y	Y	
-----	-------------------------------------------------------------------------------------	-------	-------	---	---	----	---	---	--

Outside Air Kit

AK22	Outside air kit - (flex not included)	HTI 1	\$ 68	Y	Y	Y	Y	Y	
------	---------------------------------------	-------	-------	---	---	---	---	---	--

Uninsulated Flex Duct - Chimney Air Kits/Flex Duct

UD4	4" (100mm) uninsulated flex duct for outside air - includes two 42" (1065mm) sections	HTI 1	\$ 53	Y	Y	Y	Y	Y	
-----	---------------------------------------------------------------------------------------	-------	-------	---	---	---	---	---	--

SL300 Series Pipe - Comp - SngPk - Chimney Air Kits/Flex Duct Dimensions: 8" Inner / 10.5" Outer

CAK4A	Chimney air kit (for SL300 series chimney systems only)	HTI 1	\$ 120	Y	Y	14	14	Y	
-------	---------------------------------------------------------	-------	--------	---	---	----	----	---	--

Venting Notes

Uses SL300 series chimney
Attic insulation shield standard

WarmMajic-II

Includes:

- Up to 68,200 Btu/Hour Output
- Ceramic glass
- Junction box
- Duel fans
- Arched steel faced
- Cast iron arch doors
- CAK4A
- Outside air hood
- Lined with firebrick
- Attic insulation shield
- Certified to 2020 EPA emissions standards



Required to Complete - Sold Separately: • Required to Complete - Sold Separately: Advanced Install Product training required before product ships

		Disc. Code	MSRP USD	004 IA	010 PA	014 CA	016 NC	EXP
WARMMAJIC-II	WARMMAJIC II FIREPLACE	MAJ 3	\$ 6,199	Y	Y	Y	Y	N

Options & Accessories

Finishing Template

HHT-TEMPLATE-C	Metal finishing template	HTI 1	\$ 199	Y	21	14	14	Y
----------------	--------------------------	-------	--------	---	----	----	----	---

Firescreen Mesh

MESH-HHT-C	Firescreen	HTI 3	\$ 299	Y	21	14	14	Y
------------	------------	-------	--------	---	----	----	----	---

Lintel Bar

LINTELBAR-HHT	Lintel bar	HTI 1	\$ 349	8	21	14	14	Y
---------------	------------	-------	--------	---	----	----	----	---

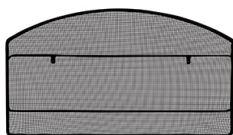

Firescreen Mesh

Heat Management

Heat Zone Kit

HEAT-ZONE-WD-C	Heat distribution kit (includes fan, grille cover, fireplace adaptor, and adjustment control) requires 6" vent for ducting	HTI 1	\$ 389	Y	Y	Y	Y	Y
----------------	----------------------------------------------------------------------------------------------------------------------------	-------	--------	---	---	---	---	---

Floor Protector (HP)

Micore Hearth Extension - Hearth Extension

HX4M	Hearth extension for 42" models (70"x 20"x 1/2") - pack of 5	HTI 1	\$ 329	Y	Y	Y	Y	N
------	--------------------------------------------------------------	-------	--------	---	---	---	---	---

Venting

Outside Air Kit

OA-RD-6	Outside air elbow kit (used to offset outside air starting collar)	HTI 1	\$ 59	Y	21	14	14	Y
---------	--------------------------------------------------------------------	-------	-------	---	----	----	----	---

Venting Notes

Requires SL300 or 8" DuraPlus pipe with the DuraPlus base plate. See venting section

When using 8" DuraPlus must use DV-6DP-IS attic insulation shield

<h1>Majestic</h1>	<h2>Fireplace - Wood - Multi-Sided</h2>	Stocked Item/Lead Time 004=Mt. Pleasant RDC 010=Kutztown RDC 014=Sacramento RDC 016=Charlotte RDC EXP=Factory Expedite Program
-------------------	-----------------------------------------	----------------------------------------------------------------------------------------------------------------------------------------------------------

Page printed 2/1/2024 3:05:35 PM CST
 Future pricing effective for shipments on or after 03/31/2024
 * Please Contact Who You Purchase This Through for MSRP Pricing

Prices in USD

Non-stock and custom product cannot be cancelled.
 Customer is responsible for freight for orders made outside of assigned RDC facility.

Designer Series See-Through 42

- Includes:**
- Full refractory lining
 - Powder coat finish
 - Safety firescreen
 - Dual gas knockouts
 - Steel grate
 - Damper
 - Outside air kit
 - Attic insulation shield
- UL/ULC Listed



Required to Complete - Sold Separately: • Flex Venting for Outside Air

		Disc. Code	MSRP USD	004 IA	010 PA	014 CA	016 NC	EXP
DSR42	42" See-Thru Radiant Wood Burning Fireplace	MAJ 1	\$ 3,799	Y	14	14	Y	N

Glass Doors - Operable

Glass Bi-Fold Door

DM1242	Original bi-fold glass doors with black trim	HTI 1	\$ 679	Y	Y	14	Y	Y
--------	----------------------------------------------	-------	--------	---	---	----	---	---



Glass Bi-Fold Door

Gas Logs - Log Set Option

Fireside Supreme Oak See-Through Gas Logs

STFSO18	18" Fireside Supreme Oak gas log set for See-Through fireplace (order hearth kit separately)	HTI 3	\$ 569	Y	14	21	14	N
STFSO24	24" Fireside Supreme Oak gas log set for See-Through fireplace (order hearth kit separately)	HTI 3	\$ 589	Y	14	21	14	N



Fireside Supreme Oak
See-Through Gas Logs

Gas Logs - Burner Option

See-Through Hearth Kit Safety Pilot

STSP18LP	18" safety pilot hearth kit for see-through fireplaces - 65,000 Btu/Hour Input (LP)	HTI 3	\$ 789	21	14	21	14	N
STSP18NG	18" safety pilot hearth kit for see-through fireplaces - 60,000 Btu/Hour Input (NG)	HTI 3	\$ 789	Y	14	21	21	N
STSP24LP	24" safety pilot hearth kit for see-through fireplaces - 69,000 Btu/Hour Input (LP)	HTI 3	\$ 819	21	14	21	14	N
STSP24NG	24" safety pilot hearth kit for see-through fireplaces - 75,000 Btu/Hour Input (NG)	HTI 3	\$ 819	Y	14	14	21	N

Floor Protector (HP)

Micore Hearth Extension - Hearth Extension

HX4M	Hearth extension for 42" models (70"x 20"x 1/2") - pack of 5	HTI 1	\$ 329	Y	Y	Y	Y	N
------	--------------------------------------------------------------	-------	--------	---	---	---	---	---

Venting

Insulated Flex Duct - Chimney Air Kits/Flex Duct

ID4	4" (100mm) insulated flex duct for outside air - includes two 42" (1065mm) sections	HTI 1	\$ 82	Y	Y	14	Y	Y
-----	-------------------------------------------------------------------------------------	-------	-------	---	---	----	---	---

Uninsulated Flex Duct - Chimney Air Kits/Flex Duct

UD4	4" (100mm) uninsulated flex duct for outside air - includes two 42" (1065mm) sections	HTI 1	\$ 53	Y	Y	Y	Y	Y
-----	---------------------------------------------------------------------------------------	-------	-------	---	---	---	---	---

SL400 Series Pipe - Term Kits & Acc - Sng Pk - Chimney Air Kits/Flex Duct

CAK5A	Chimney air kit for SL1100 and SL400 series pipe (required in Canada)	HTI 1	\$ 135	Y	Y	14	14	Y
-------	-----------------------------------------------------------------------	-------	--------	---	---	----	----	---

Venting Notes

Outside air kit standard
U.S. uses SL1100 series chimney. Canada uses SL400 series chimney and requires SLA-10
Attic insulation shield standard

Majestic	Insert - Gas
-----------------	---------------------

Stocked Item/Lead Time
 004=Mt. Pleasant RDC
 010=Kutztown RDC
 014=Sacramento RDC
 016=Charlotte RDC
 EXP=Factory Expedite Program

Prices in USD

Page printed 2/1/2024 3:05:35 PM CST
 Future pricing effective for shipments on or after 03/31/2024
 * Please Contact Who You Purchase This Through for MSRP Pricing

Non-stock and custom product cannot be cancelled.

Customer is responsible for freight for orders made outside of assigned RDC facility.

Jasper Insert 30"

Includes:

- 21,000 - 30,000 BTU/Hour Input (NG) • 6 Ceramic Fiber Split Logs
- 19,600 - 28,000 BTU/Hour Input (LP)
- IntelliFire Ignition System
- Ceramic Glass
- Glowing Embers/Lava Rock
- Battery Back Up
- Electrical Cord - 10' 3" Left, X 7' 6" Right • LP requires conversion, order LPK-MI-IPI
- Gas Flex Connector



Required to Complete - Sold Separately: • Front • Surround

		Disc. Code	MSRP USD	004 IA	010 PA	014 CA	016 NC	EXP
JASPER30IN	Jasper Medium 30" direct vent gas insert with IPI ignition system (NG)	MAJ 3	\$ 2,139	Y	14	Y	14	N

Fronts - Non-Operable (Required to Complete)

Clean Screen

CSFI30BK	Clean 30" screen front - Black	MAJ 3	\$ 409	Y	Y	Y	14	Y
----------	--------------------------------	-------	--------	---	---	---	----	---

Contemporary Arched Front

CASFI30BK	Contemporary Arch 30" screen front - Black	MAJ 3	\$ 449	Y	Y	Y	14	Y
-----------	--------------------------------------------	-------	--------	---	---	---	----	---

Inside Fit

INFIT-30-BK	Inside fit 30" screen front - Black	HTI 3	\$ 359	Y	Y	Y	14	Y
-------------	-------------------------------------	-------	--------	---	---	---	----	---



Clean Screen

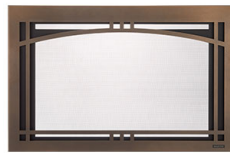

Contemporary Arched Front



Inside Fit

Metal Surrounds (Required to Complete)

Surrounds - Small

MI30-4027-BK	Small 30" surround 40" x 27" - Black	HTI 3	\$ 369	Y	Y	Y	Y	Y
MI30-4027-NB	Small 30" surround 40" x 27" - New Bronze	HTI 3	\$ 409	Y	Y	Y	21	Y

Surrounds - Medium									
MI30-4230D-BK	Medium 30" surround 42" x 30" x 2" deep - Black	HTI 3	\$ 399	Y	Y	Y	14	Y	
MI30-4230-BK	Medium 30" surround 42" x 30" - Black	HTI 3	\$ 399	Y	Y	Y	Y	Y	
MI30-4230-NB	Medium 30" surround 42" x 30" - New Bronze	HTI 3	\$ 429	Y	Y	Y	14	Y	
Surrounds - Large									
MI30-4432-BK	Large 30" surround 44" x 32" - Black	HTI 3	\$ 419	Y	Y	Y	14	Y	
MI30-4432-NB	Large 30" surround 44" x 32" - New Bronze	HTI 3	\$ 459	Y	Y	Y	14	Y	
Custom Surround									
MI30-5040CS-BK	On site 30" customizable surround - 50" w x 40" h (comes 4 sided with a 6" bottom, can be trimmed to make 3 sided)	HTI 3	\$ 479	Y	Y	Y	14	N	
CUST-SRND-MI	Custom surround metal inserts (see custom surround order form for details)	HTI 3	\$ 839	14	14	21	14	Y	
Control, remotes, wall switches (Required to Complete)									
Battery Back Up									
BATTERY-WSK	Battery backup wall switch kit for units with IFT control systems. Includes: On/Off Wall Switch, USB-C Port, Battery Backup, Cover Plate, 12' Wire Harness	HTI 1	\$ 179	Y	14	14	14	Y	
Smart Stat Remote Control									
SMART-STAT-HHT	Remote Control - IPI or SP (on/off, temp readout, thermostat mode, timer mode)	HTI 1	\$ 289	Y	Y	Y	Y	Y	



Battery Back Up

Venting (Required to Complete)									
Gas Insert Venting - 30/30 Termination Kits									
LINK-DV4-30B	Direct vent insert kit - one 4 - liner, one 30 - liner, plus term cap components	HTI 1	\$ 549	Y	Y	Y	Y	Y	
LINKSQB-DV4-30	Direct vent insert kit - one 4 - liner, one 30 - liner, plus black term cap components	HTI 1	\$ 649	Y	Y	14	14	Y	
LINK-DV30B	Direct vent insert kit - two 30 - liners, plus term cap components	HTI 1	\$ 649	Y	Y	Y	Y	Y	
LINKSQB-DV30	Direct vent insert kit - two 30 - liners, plus black term cap components	HTI 1	\$ 729	Y	Y	Y	14	Y	
LINKSQC-DV30	Direct vent insert kit - two 30" liners, plus faux copper term cap components	HTI 1	\$ 789	Y	Y	Y	14	Y	
Conversion Kit									
Conversion Kit									
LPK-MI-IPI	LP conversion kit for metal insert with IPI	HTI 3	\$ 0	Y	Y	Y	14	Y	
Refractory Upgrade									
Fiber Refractory									
BRICKMI30TB	Traditional 30" Brick interior panels - Tavern Brown	MAJ 3	\$ 289	Y	Y	Y	14	Y	
BRICKMI30CR	Traditional 30" Brick interior panels - Cottage Red	MAJ 3	\$ 289	Y	Y	Y	28	Y	

Fans

Fan

GFK-160C	Fan kit 160 CFM (fan only)	HTI 1	\$	259	Y	Y	Y	Y	Y
GFK-160A	Fan kit 160 CFM (includes rheostat and temperature sensor)	HTI 1	\$	319	Y	Y	Y	Y	Y

Venting Notes

Requires: LINK-DV30B, LINKSQB-DV30, LINKSQC-DV30, LINK-DV4-30B, LINKSQB-DV-30 or LINKSQC-DV4-30 flex liner kit. Refer to Venting section.

Ruby Insert 25"

Includes:

- 18,900 - 27,000 BTU/Hour Input (NG)
- 17,500 - 25,000 BTU/Hour Input (LP)
- IntelliFire Touch Ignition System
- RC400 Remote Control
- GFK-160A Variable Fan
- Decorative Brick Base
- Ceramic Glass
- Glowing Embers/Mystic Embers
- Battery Back Up
- Electrical Cord - 10' 6" Left, X 8" Right
- Gas Flex Connector
- 7 Ceramic Fiber Split Logs



Required to Complete - Sold Separately: • Front • Surround

		Disc. Code	MSRP USD	004 IA	010 PA	014 CA	016 NC	EXP
RUBY25IL	Ruby small 25" direct vent gas insert with intellifire touch ignition system (LP)	MAJ 3	\$ 2,709	Y	14	14	14	N
RUBY25IN	Ruby small 25" direct vent gas insert with intellifire touch ignition system (NG)	MAJ 3	\$ 2,709	Y	Y	Y	14	N

Fronts - Non-Operable (Required to Complete)

Clean Screen

CSFI25BK	Clean 25" screen front - Black	MAJ 3	\$ 389	Y	Y	Y	14	Y
CSFI25NB	Clean 25" screen front - New Bronze	MAJ 3	\$ 409	Y	14	14	14	Y

Contemporary Arched Front

CASFI25BK	Contemporary Arch 25" screen front - Black	MAJ 3	\$ 419	14	14	14	14	Y
CASFI25NB	Contemporary Arch 25" screen front - New Bronze	MAJ 3	\$ 449	14	14	14	14	Y

Inside Fit

INFIT-25-BK	Inside fit 25" screen front - Black	HTI 3	\$ 339	Y	Y	Y	14	Y
-------------	-------------------------------------	-------	--------	---	---	---	----	---



Clean Screen

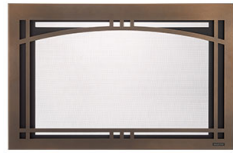

Contemporary Arched Front



Inside Fit

Metal Surrounds (Required to Complete)

Surrounds - Small

MI25-3523-BK	Small 25" surround 35" x 23" - Black	HTI 3	\$ 349	Y	Y	Y	14	Y
MI25-3523-NB	Small 25" surround 35" x 23" - New Bronze	HTI 3	\$ 389	14	14	14	14	Y

Surrounds - Medium

MI25-3726-BK	Medium 25" surround 37" x 26" - Black	HTI 3	\$ 369	Y	Y	Y	14	Y
MI25-3726-NB	Medium 25" surround 37" x 26" - New Bronze	HTI 3	\$ 409	14	14	14	14	Y

Surrounds - Large

MI25-3928-BK	Large 25" surround 39" x 28" - Black	HTI 3	\$ 399	Y	Y	Y	14	Y
MI25-3928-NB	Large 25" surround 39" x 28" - New Bronze	HTI 3	\$ 429	14	14	14	14	Y

Custom Surround									
MI25-5040CS-BK	On site 25" customizable surround - 50" w x 40" h (comes 4 sided with a 6" bottom, can be trimmed to make 3 sided)	HTI 3	\$	459	Y	Y	Y	14	N
CUST-SRND-MI	Custom surround metal inserts (see custom surround order form for details)	HTI 3	\$	839	14	14	21	14	Y

Venting (Required to Complete)

Gas Insert Venting - 30/30 Termination Kits

LINK-DV4-30B	Direct vent insert kit - one 4 - liner, one 30 - liner, plus term cap components	HTI 1	\$	549	Y	Y	Y	Y	Y
LINKSQB-DV4-30	Direct vent insert kit - one 4 - liner, one 30 - liner, plus black term cap components	HTI 1	\$	649	Y	Y	14	14	Y
LINK-DV30B	Direct vent insert kit - two 30 - liners, plus term cap components	HTI 1	\$	649	Y	Y	Y	Y	Y
LINKSQB-DV30	Direct vent insert kit - two 30 - liners, plus black term cap components	HTI 1	\$	729	Y	Y	Y	14	Y
LINKSQC-DV30	Direct vent insert kit - two 30" liners, plus faux copper term cap components	HTI 1	\$	789	Y	Y	Y	14	Y

Liner Kit

Glass Liner

LINER-BK-25	Reflective Black Glass Liner 25" traditional units	HTI 3	\$	499	Y	Y	Y	14	Y
-------------	----------------------------------------------------	-------	----	-----	---	---	---	----	---

Refractory Upgrade

Fiber Refractory

BRICKMI25CR	Traditional 25" Brick interior panels - Cottage Red	MAJ 3	\$	279	Y	28	35	35	Y
BRICKMI25TB	Traditional 25" Brick interior panels - Tavern Brown	MAJ 3	\$	279	Y	14	14	14	Y

Control, remotes, wall switches

Battery Back Up

BATTERY-WSK	Battery backup wall switch kit for units with IFT control systems. Includes: On/Off Wall Switch, USB-C Port, Battery Backup, Cover Plate, 12' Wire Harness	HTI 1	\$	179	Y	14	14	14	Y
-------------	------------------------------------------------------------------------------------------------------------------------------------------------------------	-------	----	-----	---	----	----	----	---

IntelliFire app

IFT-WFM	IntelliFire Wi-Fi Module that works with the IntelliFire iOS and Android app. Use to control all the features of your fireplace via a smart device. An RC400, RC450 or RC150 is required for thermostat control	HTI 1	\$	219	Y	Y	Y	Y	Y
---------	-----------------------------------------------------------------------------------------------------------------------------------------------------------------------------------------------------------------	-------	----	-----	---	---	---	---	---

Remote/Wall Switch/Wall Thermostat

IFT-RC150	IntelliFire Touch white wireless wall switch (on/off, cold climate, battery strength indicator)	HTI 1	\$	116	Y	14	14	Y	Y
-----------	-------------------------------------------------------------------------------------------------	-------	----	-----	---	----	----	---	---

Touch Screen Remote

IFT-RC400	IntelliFire Touch black remote control, docking station and auxiliary control module (on/off, flame height, thermostat mode, fan control, child lock, cold climate, timer mode, hot indicator, lights, on-screen maintenance and troubleshooting notifications)	HTI 1	\$	379	Y	Y	Y	Y	Y
-----------	-----------------------------------------------------------------------------------------------------------------------------------------------------------------------------------------------------------------------------------------------------------------	-------	----	-----	---	---	---	---	---



Battery Back Up



IntelliFire app

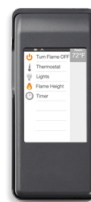

Touch Screen Remote

Venting Notes

Requires: LINK-DV30B, LINKSQB-DV30, LINKSQC-DV30, LINK-DV4-30B, LINKSQB-DV-30 or LINKSQC-DV4-30 flex liner kit. Refer to Venting section.

Ruby Insert 30"

Includes:

- 22,890 - 32,700 BTU/Hour Input (NG)
- 22,400 - 32,000 BTU/Hour Input (LP)
- IntelliFire Touch Ignition System
- RC400 Remote Control
- GFK-160A Variable Fan
- Decorative Brick Base
- Ceramic Glass
- Glowing Embers/Mystic Embers
- Battery Back Up
- Electrical Cord - 10' 3" Left, X 7' 6" Right
- Gas Flex Connector
- 8 Ceramic Fiber Split Logs
- If changing media, follow required number of bags below:
- --> Crushed Glass: 2 bags --> Natural Stones: 2 bags



Required to Complete - Sold Separately: • Front • Surround

		Disc. Code	MSRP USD	004 IA	010 PA	014 CA	016 NC	EXP
RUBY30IL	Ruby medium 30" direct vent gas insert with intellifire touch ignition system (LP)	MAJ 3	\$ 2,879	Y	Y	14	14	N
RUBY30IN	Ruby medium 30" direct vent gas insert with intellifire touch ignition system (NG)	MAJ 3	\$ 2,879	Y	Y	Y	14	N

Fronts - Non-Operable (Required to Complete)

Clean Screen

CSFI30BK	Clean 30" screen front - Black	MAJ 3	\$ 409	Y	Y	Y	14	Y
CSFI30NB	Clean 30" screen front - New Bronze	MAJ 3	\$ 429	Y	Y	Y	14	Y

Contemporary Arched Front

CASFI30BK	Contemporary Arch 30" screen front - Black	MAJ 3	\$ 449	Y	Y	Y	14	Y
CASFI30NB	Contemporary Arch 30" screen front - New Bronze	MAJ 3	\$ 469	Y	Y	Y	14	Y

Inside Fit

INFIT-30-BK	Inside fit 30" screen front - Black	HTI 3	\$ 359	Y	Y	Y	14	Y
-------------	-------------------------------------	-------	--------	---	---	---	----	---



Clean Screen

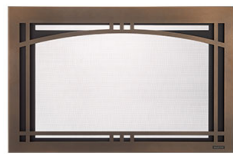

Contemporary Arched Front



Inside Fit

Metal Surrounds (Required to Complete)

Surrounds - Small

MI30-4027-BK	Small 30" surround 40" x 27" - Black	HTI 3	\$ 369	Y	Y	Y	Y	Y
MI30-4027-NB	Small 30" surround 40" x 27" - New Bronze	HTI 3	\$ 409	Y	Y	Y	21	Y

Surrounds - Medium						
MI30-4230-BK	Medium 30" surround 42" x 30" - Black	HTI 3	\$ 399	Y	Y	Y
MI30-4230D-BK	Medium 30" surround 42" x 30" x 2" deep - Black	HTI 3	\$ 399	Y	Y	14
MI30-4230-NB	Medium 30" surround 42" x 30" - New Bronze	HTI 3	\$ 429	Y	Y	14
Surrounds - Large						
MI30-4432-BK	Large 30" surround 44" x 32" - Black	HTI 3	\$ 419	Y	Y	14
MI30-4432-NB	Large 30" surround 44" x 32" - New Bronze	HTI 3	\$ 459	Y	Y	14
Custom Surround						
MI30-5040CS-BK	On site 30" customizable surround - 50" w x 40" h (comes 4 sided with a 6" bottom, can be trimmed to make 3 sided)	HTI 3	\$ 479	Y	Y	14
CUST-SRND-MI	Custom surround metal inserts (see custom surround order form for details)	HTI 3	\$ 839	14	14	21
Venting (Required to Complete)						
Gas Insert Venting - 30/30 Termination Kits						
LINK-DV4-30B	Direct vent insert kit - one 4 - liner, one 30 - liner, plus term cap components	HTI 1	\$ 549	Y	Y	Y
LINKSQB-DV4-30	Direct vent insert kit - one 4 - liner, one 30 - liner, plus black term cap components	HTI 1	\$ 649	Y	Y	14
LINK-DV30B	Direct vent insert kit - two 30 - liners, plus term cap components	HTI 1	\$ 649	Y	Y	Y
LINKSQB-DV30	Direct vent insert kit - two 30 - liners, plus black term cap components	HTI 1	\$ 729	Y	Y	14
LINKSQC-DV30	Direct vent insert kit - two 30" liners, plus faux copper term cap components	HTI 1	\$ 789	Y	Y	14
Hearth Kit						
Upgrade Kit						
CKRUBY30	Contemporary conversion kit Ruby 30" insert (includes 1 bag Onyx, 1 bag Diamond media); not approved for use with Fiber Refractory or Light Kit (MI-ALK)	MAJ 3	\$ 479	Y	14	14
Media						
Driftwood Logs						
DWLG-MI-MAJ	Driftwood Log set (requires CKRUBY30 or CKRUBY35 with media installed)	MAJ 1	\$ 259	Y	21	14
Media						
GLASS-SP	Glass, Sapphire (1 bag)	MAJ 1	\$ 71	Y	Y	14
GLASS-OY	Glass, Onyx (1 bag)	MAJ 1	\$ 71	Y	Y	14
GLASS-DM	Glass, Diamond (1 bag)	MAJ 1	\$ 71	Y	Y	14
GLASS-BZ	Glass, Bronze (1 bag)	MAJ 1	\$ 71	Y	21	14
Stones						
STONES-NATURAL	Natural stones (1 bag)	HTI 1	\$ 111	Y	Y	Y
Lighting						
Accent Light Kit						
MI-ALK	Ambient Light Kit (not for use in 25" models) (Not recommended for use with Reflective Black Glass Liner)	HTI 3	\$ 489	Y	Y	14
Liner Kit						
Glass Liner						
LINER-BK-30	Reflective Black Glass Liner 30" traditional units	HTI 3	\$ 529	Y	Y	14
LINER-MOD30-BK	Reflective Black Glass Liner for 30" contemporary units	HTI 3	\$ 529	Y	Y	14

Refractory Upgrade					
Fiber Refractory					
BRICKMI30CR	Traditional 30" Brick interior panels - Cottage Red	MAJ 3	\$	289	Y Y Y 28 Y
BRICKMI30TB	Traditional 30" Brick interior panels - Tavern Brown	MAJ 3	\$	289	Y Y Y 14 Y
Control, remotes, wall switches					
Battery Back Up					
BATTERY-WSK	Battery backup wall switch kit for units with IFT control systems. Includes: On/Off Wall Switch, USB-C Port, Battery Backup, Cover Plate, 12' Wire Harness	HTI 1	\$	179	Y 14 14 14 Y
IntelliFire app					
IFT-WFM	IntelliFire Wi-Fi Module that works with the IntelliFire iOS and Android app. Use to control all the features of your fireplace via a smart device. An RC400, RC450 or RC150 is required for thermostat control	HTI 1	\$	219	Y Y Y Y Y
Remote/Wall Switch/Wall Thermostat					
IFT-RC150	IntelliFire Touch white wireless wall switch (on/off, cold climate, battery strength indicator)	HTI 1	\$	116	Y 14 14 Y Y
Touch Screen Remote					
IFT-RC400	IntelliFire Touch black remote control, docking station and auxiliary control module (on/off, flame height, thermostat mode, fan control, child lock, cold climate, timer mode, hot indicator, lights, on-screen maintenance and troubleshooting notifications)	HTI 1	\$	379	Y Y Y Y Y



Battery Back Up



IntelliFire app

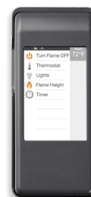

Touch Screen Remote

Venting Notes
 Requires: LINK-DV30B, LINKSQB-DV30, LINKSQC-DV30, LINK-DV4-30B, LINKSQB-DV-30 or LINKSQC-DV4-30 flex liner kit. Refer to Venting section.

Ruby Insert 35"

Includes:

- 24,500 - 35,000 BTU/Hour Input (NG)
- 24,500 - 35,000 BTU/Hour Input (LP)
- IntelliFire Touch Ignition System
- RC400 Remote Control
- GFK-160A Variable Fan
- Decorative Brick Base
- Ceramic Glass
- Glowing Embers/Mystic Embers
- Battery Back Up
- Electrical Cord - 10" Left, X 7" Right
- Gas Flex Connector
- 9 Ceramic Fiber Split Logs
- If changing media, follow required number of bags below:
- --> Crushed Glass: 2 bags --> Natural Stones: 2 bags



Required to Complete - Sold Separately: • Front • Surround

		Disc. Code	MSRP USD	004 IA	010 PA	014 CA	016 NC	EXP
RUBY35IL	Ruby large 35" direct vent gas insert with intellifire touch ignition system (LP)	MAJ 3	\$ 3,009	Y	Y	14	14	N
RUBY35IN	Ruby large 35" direct vent gas insert with intellifire touch ignition system (NG)	MAJ 3	\$ 3,009	Y	Y	Y	14	N

Fronts - Non-Operable (Required to Complete)

Clean Screen

CSFI35BK	Clean 35" screen front - Black	MAJ 3	\$ 429	Y	Y	Y	14	Y
CSFI35NB	Clean 35" screen front - New Bronze	MAJ 3	\$ 459	Y	14	14	14	Y

Contemporary Arched Front

CASFI35BK	Contemporary Arch 35" screen front - Black	MAJ 3	\$ 469	Y	14	Y	14	Y
CASFI35NB	Contemporary Arch 35" screen front - New Bronze	MAJ 3	\$ 489	14	Y	Y	14	Y

Inside Fit

INFIT-35-BK	Inside fit 35" screen front - Black	HTI 3	\$ 389	Y	Y	Y	14	Y
-------------	-------------------------------------	-------	--------	---	---	---	----	---



Clean Screen

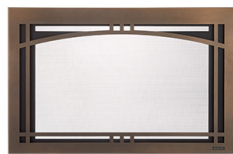

Contemporary Arched Front



Inside Fit

Metal Surrounds (Required to Complete)

Surrounds - Small

MI35-4229-BK	Small 35" surround 42" x 29" - Black	HTI 3	\$ 399	Y	Y	Y	21	Y
MI35-4229-NB	Small 35" surround 42" x 29" - New Bronze	HTI 3	\$ 429	Y	Y	Y	14	Y

Surrounds - Medium

MI35-4432-BK	Medium 35" surround 44" x 32" - Black	HTI 3	\$ 419	Y	Y	Y	Y	Y
MI35-4432D-BK	Medium 35" surround 44" x 32" x 2" deep - Black	HTI 3	\$ 419	14	14	Y	14	Y
MI35-4432-NB	Medium 35" surround 44" x 32" - New Bronze	HTI 3	\$ 459	14	Y	Y	14	Y

Surrounds - Large									
MI35-4832-BK	Large 35" surround 48" x 32" - Black	HTI 3	\$ 449	Y	Y	Y	14	Y	
MI35-4832-NB	Large 35" surround 48" x 32" - New Bronze	HTI 3	\$ 479	14	14	14	14	Y	
Custom Surround									
MI35-5040CS-BK	On site 35" customizable surround - 50" w x 40" h (comes 4 sided with a 5" bottom, can be trimmed to make 3 sided)	HTI 3	\$ 499	Y	Y	Y	14	Y	
CUST-SRND-MI	Custom surround metal inserts (see custom surround order form for details)	HTI 3	\$ 839	14	14	21	14	Y	
Venting (Required to Complete)									
Gas Insert Venting - 30/30 Termination Kits									
LINK-DV4-30B	Direct vent insert kit - one 4 - liner, one 30 - liner, plus term cap components	HTI 1	\$ 549	Y	Y	Y	Y	Y	
LINKSQB-DV4-30	Direct vent insert kit - one 4 - liner, one 30 - liner, plus black term cap components	HTI 1	\$ 649	Y	Y	14	14	Y	
LINK-DV30B	Direct vent insert kit - two 30 - liners, plus term cap components	HTI 1	\$ 649	Y	Y	Y	Y	Y	
LINKSQB-DV30	Direct vent insert kit - two 30 - liners, plus black term cap components	HTI 1	\$ 729	Y	Y	Y	14	Y	
LINKSQC-DV30	Direct vent insert kit - two 30" liners, plus faux copper term cap components	HTI 1	\$ 789	Y	Y	Y	14	Y	
Hearth Kit									
Upgrade Kit									
CKRUBY35	Contemporary conversion kit Ruby 35" insert (includes 1 bag Onyx, 1 bag Diamond media); not approved for use with Fiber Refractory or light kit (MI-ALK)	MAJ 3	\$ 599	14	21	14	14	Y	
Media									
Driftwood Logs									
DWLG-MI-MAJ	Driftwood Log set (requires CKRUBY30 or CKRUBY35 with media installed)	MAJ 1	\$ 259	Y	21	14	14	Y	
Media									
GLASS-OY	Glass, Onyx (1 bag)	MAJ 1	\$ 71	Y	Y	14	Y	Y	
GLASS-BZ	Glass, Bronze (1 bag)	MAJ 1	\$ 71	Y	21	14	14	Y	
GLASS-DM	Glass, Diamond (1 bag)	MAJ 1	\$ 71	Y	Y	14	Y	Y	
GLASS-SP	Glass, Sapphire (1 bag)	MAJ 1	\$ 71	Y	Y	14	14	Y	
Stones									
STONES-NATURAL	Natural stones (1 bag)	HTI 1	\$ 111	Y	Y	Y	Y	Y	
Lighting									
Accent Light Kit									
MI-ALK	Ambient Light Kit (not for use in 25" models) (Not recommended for use with Reflective Black Glass Liner)	HTI 3	\$ 489	Y	Y	Y	14	Y	
Liner Kit									
Glass Liner									
LINER-BK-35	Reflective Black Glass Liner 35" traditional units	HTI 3	\$ 559	Y	Y	Y	14	Y	
LINER-MOD35-BK	Reflective Black Glass Liner for 35" contemporary units	HTI 3	\$ 659	Y	Y	Y	14	Y	
Refractory Upgrade									
Fiber Refractory									
BRICKMI35CR	Traditional 35" Brick interior panels - Cottage Red	MAJ 3	\$ 299	Y	Y	Y	28	Y	
BRICKMI35TB	Traditional 35" Brick interior panels - Tavern Brown	MAJ 3	\$ 299	Y	28	Y	28	Y	

Control, remotes, wall switches

Battery Back Up

BATTERY-WSK	Battery backup wall switch kit for units with IFT control systems. Includes: On/Off Wall Switch, USB-C Port, Battery Backup, Cover Plate, 12' Wire Harness	HTI 1	\$	179	Y	14	14	14	Y
-------------	------------------------------------------------------------------------------------------------------------------------------------------------------------	-------	----	-----	---	----	----	----	---

IntelliFire app

IFT-WFM	IntelliFire Wi-Fi Module that works with the IntelliFire iOS and Android app. Use to control all the features of your fireplace via a smart device. An RC400, RC450 or RC150 is required for thermostat control	HTI 1	\$	219	Y	Y	Y	Y	Y
---------	-----------------------------------------------------------------------------------------------------------------------------------------------------------------------------------------------------------------	-------	----	-----	---	---	---	---	---

Remote/Wall Switch/Wall Thermostat

IFT-RC150	IntelliFire Touch white wireless wall switch (on/off, cold climate, battery strength indicator)	HTI 1	\$	116	Y	14	14	Y	Y
-----------	-------------------------------------------------------------------------------------------------	-------	----	-----	---	----	----	---	---

Touch Screen Remote

IFT-RC400	IntelliFire Touch black remote control, docking station and auxiliary control module (on/off, flame height, thermostat mode, fan control, child lock, cold climate, timer mode, hot indicator, lights, on-screen maintenance and troubleshooting notifications)	HTI 1	\$	379	Y	Y	Y	Y	Y
-----------	-----------------------------------------------------------------------------------------------------------------------------------------------------------------------------------------------------------------------------------------------------------------	-------	----	-----	---	---	---	---	---



Battery Back Up



IntelliFire app

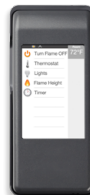

Touch Screen Remote

Venting Notes

Requires: LINK-DV30B, LINKSQB-DV30, LINKSQC-DV30, LINK-DV4-30B, LINKSQB-DV-30 or LINKSQC-DV4-30 flex liner kit. Refer to Venting section.

Trilliant Insert 25"

Includes:

- 18,900 - 27,000 BTU/Hour Input (NG)
- 17,500 - 25,000 BTU/Hour Input (LP)
- IntelliFire Touch Ignition System
- RC400 Remote Control
- GFK-160A Variable Fan
- Heat Exchanger Tubes
- Canyon Brown Brick Interior
- Decorative Brick Base
- Ceramic Glass
- Glowing Embers
- Battery Back Up
- Electrical Cord - 10' 6" Left, X 8' Right
- Gas Flex Connector
- LP Conversion Kit



Required to Complete - Sold Separately: • Front • Surround • Venting

		Disc. Code	MSRP USD	004 IA	010 PA	014 CA	016 NC	EXP
TRILLIANT25IN	Trilliant small 25" direct vent gas insert with intelligifire touch ignition system (NG)	MAJ 3	\$ 3,069	Y	Y	Y	14	N

Fronts - Non-Operable (Required to Complete)

Clean Screen

CSFI25BK	Clean 25" screen front - Black	MAJ 3	\$ 389	Y	Y	Y	14	Y
CSFI25NB	Clean 25" screen front - New Bronze	MAJ 3	\$ 409	Y	14	14	14	Y

Forged Arch

FA-TRI25-BK	Forged Arch 25" screen front - Black	MAJ 3	\$ 1,339	14	14	14	14	Y
-------------	--------------------------------------	-------	----------	----	----	----	----	---

Inside Fit

INFIT-25-BK	Inside fit 25" screen front - Black	HTI 3	\$ 339	Y	Y	Y	14	Y
-------------	-------------------------------------	-------	--------	---	---	---	----	---

Mission Fullview

MFV-TRI25-BK	Mission Full View 25" screen front - Black	MAJ 3	\$ 469	14	14	14	14	Y
MFV-TRI25-NB	Mission Full View 25" screen front - New Bronze	MAJ 3	\$ 509	14	14	14	14	Y

Tuscan Arch

TA-TRI25-BK	Tuscan Arch 25" screen front - Black	MAJ 3	\$ 659	14	14	14	14	Y
TA-TRI25-NB	Tuscan Arch 25" screen front - New Bronze	MAJ 3	\$ 699	14	14	14	14	Y



Clean Screen



Inside Fit

Metal Surrounds (Required to Complete)

Surrounds - Small

MI25-3523-BK	Small 25" surround 35" x 23" - Black	HTI 3	\$ 349	Y	Y	Y	14	Y
MI25-3523-NB	Small 25" surround 35" x 23" - New Bronze	HTI 3	\$ 389	14	14	14	14	Y

Surrounds - Medium								
MI25-3726-BK	Medium 25" surround 37" x 26" - Black	HTI 3	\$ 369	Y	Y	Y	14	Y
MI25-3726-NB	Medium 25" surround 37" x 26" - New Bronze	HTI 3	\$ 409	14	14	14	14	Y

Surrounds - Large								
MI25-3928-BK	Large 25" surround 39" x 28" - Black	HTI 3	\$ 399	Y	Y	Y	14	Y
MI25-3928-NB	Large 25" surround 39" x 28" - New Bronze	HTI 3	\$ 429	14	14	14	14	Y

Custom Surround								
MI25-5040CS-BK	On site 25" customizable surround - 50" w x 40" h (comes 4 sided with a 6" bottom, can be trimmed to make 3 sided)	HTI 3	\$ 459	Y	Y	Y	14	N
CUST-SRND-MI	Custom surround metal inserts (see custom surround order form for details)	HTI 3	\$ 839	14	14	21	14	Y

Venting (Required to Complete)

Gas Insert Venting - 30/30 Termination Kits								
LINK-DV4-30B	Direct vent insert kit - one 4 - liner, one 30 - liner, plus term cap components	HTI 1	\$ 549	Y	Y	Y	Y	Y
LINKSQB-DV4-30	Direct vent insert kit - one 4 - liner, one 30 - liner, plus black term cap components	HTI 1	\$ 649	Y	Y	14	14	Y
LINK-DV30B	Direct vent insert kit - two 30 - liners, plus term cap components	HTI 1	\$ 649	Y	Y	Y	Y	Y
LINKSQB-DV30	Direct vent insert kit - two 30 - liners, plus black term cap components	HTI 1	\$ 729	Y	Y	Y	14	Y
LINKSQC-DV30	Direct vent insert kit - two 30" liners, plus faux copper term cap components	HTI 1	\$ 789	Y	Y	Y	14	Y

Liner Kit

Glass Liner								
LINER-BK-25	Reflective Black Glass Liner 25" traditional units	HTI 3	\$ 499	Y	Y	Y	14	Y

Control, remotes, wall switches

IntelliFire app								
IFT-WFM	IntelliFire Wi-Fi Module that works with the IntelliFire iOS and Android app. Use to control all the features of your fireplace via a smart device. An RC400, RC450 or RC150 is required for thermostat control	HTI 1	\$ 219	Y	Y	Y	Y	Y

Remote/Wall Switch/Wall Thermostat

IFT-RC150	IntelliFire Touch white wireless wall switch (on/off, cold climate, battery strength indicator)	HTI 1	\$ 116	Y	14	14	Y	Y
-----------	-------------------------------------------------------------------------------------------------	-------	--------	---	----	----	---	---

Touch Screen Remote

IFT-RC400	IntelliFire Touch black remote control, docking station and auxiliary control module (on/off, flame height, thermostat mode, fan control, child lock, cold climate, timer mode, hot indicator, lights, on-screen maintenance and troubleshooting notifications)	HTI 1	\$ 379	Y	Y	Y	Y	Y
-----------	-----------------------------------------------------------------------------------------------------------------------------------------------------------------------------------------------------------------------------------------------------------------	-------	--------	---	---	---	---	---



IntelliFire app

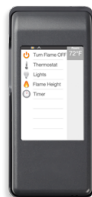

Touch Screen Remote

Venting Notes
 Requires: LINK-DV30B, LINKSQB-DV30, LINKSQC-DV30, LINK-DV4-30B, LINKSQB-DV-30 or LINKSQC-DV4-30 flex liner kit. Refer to Venting section.

Trilliant Insert 30"

Includes:

- 22,890 - 32,700 BTU/Hour Input (NG)
- 22,400 - 32,000 BTU/Hour Input (LP)
- IntelliFire Touch Ignition System
- RC400 Remote Control
- GFK-160A Variable Fan
- Heat Exchanger Tubes
- Accent Lights
- Canyon Brown Brick Interior
- Decorative Brick Base
- Ceramic Glass
- Glowing Embers
- Battery Back Up
- Electrical Cord - 10' 3" Left, X 7' 6" Right
- Gas Flex Connector
- LP Conversion Kit



Required to Complete - Sold Separately: • Front • Surround
• Venting

		Disc. Code	MSRP USD	004 IA	010 PA	014 CA	016 NC	EXP
TRILLIANT30IN	Trilliant medium 30" direct vent gas insert with intellifire touch ignition system (NG)	MAJ 3	\$ 3,219	Y	Y	Y	14	N

Fronts - Non-Operable (Required to Complete)

Clean Screen

CSFI30BK	Clean 30" screen front - Black	MAJ 3	\$ 409	Y	Y	Y	14	Y
CSFI30NB	Clean 30" screen front - New Bronze	MAJ 3	\$ 429	Y	Y	Y	14	Y

Forged Arch

FA-TRI30-BK	Forged Arch 30" screen front - Black	MAJ 3	\$ 1,389	14	14	14	14	Y
-------------	--------------------------------------	-------	----------	----	----	----	----	---

Inside Fit

INFIT-30-BK	Inside fit 30" screen front - Black	HTI 3	\$ 359	Y	Y	Y	14	Y
-------------	-------------------------------------	-------	--------	---	---	---	----	---

Mission Fullview

MFV-TRI30-BK	Mission Full View 30" screen front - Black	MAJ 3	\$ 509	Y	Y	Y	14	Y
MFV-TRI30-NB	Mission Full View 30" screen front - New Bronze	MAJ 3	\$ 559	14	14	14	14	Y

Tuscan Arch

TA-TRI30-BK	Tuscan Arch 30" screen front - Black	MAJ 3	\$ 699	Y	Y	Y	14	Y
TA-TRI30-NB	Tuscan Arch 30" screen front - New Bronze	MAJ 3	\$ 759	14	14	14	14	Y



Clean Screen



Inside Fit

Metal Surrounds (Required to Complete)

Surrounds - Small

MI30-4027-BK	Small 30" surround 40" x 27" - Black	HTI 3	\$ 369	Y	Y	Y	Y	Y
MI30-4027-NB	Small 30" surround 40" x 27" - New Bronze	HTI 3	\$ 409	Y	Y	Y	21	Y

Surrounds - Medium

MI30-4230-BK	Medium 30" surround 42" x 30" - Black	HTI 3	\$ 399	Y	Y	Y	Y	Y
MI30-4230D-BK	Medium 30" surround 42" x 30" x 2" deep - Black	HTI 3	\$ 399	Y	Y	Y	14	Y
MI30-4230-NB	Medium 30" surround 42" x 30" - New Bronze	HTI 3	\$ 429	Y	Y	Y	14	Y

Surrounds - Large

MI30-4432-BK	Large 30" surround 44" x 32" - Black	HTI 3	\$ 419	Y	Y	Y	14	Y
MI30-4432-NB	Large 30" surround 44" x 32" - New Bronze	HTI 3	\$ 459	Y	Y	Y	14	Y

Custom Surround

MI30-5040CS-BK	On site 30" customizable surround - 50" w x 40" h (comes 4 sided with a 6" bottom, can be trimmed to make 3 sided)	HTI 3	\$ 479	Y	Y	Y	14	N
CUST-SRND-MI	Custom surround metal inserts (see custom surround order form for details)	HTI 3	\$ 839	14	14	21	14	Y

Venting (Required to Complete)

Gas Insert Venting - 30/30 Termination Kits

LINK-DV4-30B	Direct vent insert kit - one 4 - liner, one 30 - liner, plus term cap components	HTI 1	\$ 549	Y	Y	Y	Y	Y
LINK-DV30B	Direct vent insert kit - two 30 - liners, plus term cap components	HTI 1	\$ 649	Y	Y	Y	Y	Y
LINKSQB-DV4-30	Direct vent insert kit - one 4 - liner, one 30 - liner, plus black term cap components	HTI 1	\$ 649	Y	Y	14	14	Y
LINKSQB-DV30	Direct vent insert kit - two 30 - liners, plus black term cap components	HTI 1	\$ 729	Y	Y	Y	14	Y
LINKSQC-DV30	Direct vent insert kit - two 30" liners, plus faux copper term cap components	HTI 1	\$ 789	Y	Y	Y	14	Y

Liner Kit

Glass Liner

LINER-BK-30	Reflective Black Glass Liner 30" traditional units	HTI 3	\$ 529	Y	Y	Y	14	Y
-------------	----------------------------------------------------	-------	--------	---	---	---	----	---

Control, remotes, wall switches

IntelliFire app

IFT-WFM	IntelliFire Wi-Fi Module that works with the IntelliFire iOS and Android app. Use to control all the features of your fireplace via a smart device. An RC400, RC450 or RC150 is required for thermostat control	HTI 1	\$ 219	Y	Y	Y	Y	Y
---------	-----------------------------------------------------------------------------------------------------------------------------------------------------------------------------------------------------------------	-------	--------	---	---	---	---	---

Remote/Wall Switch/Wall Thermostat

IFT-RC150	IntelliFire Touch white wireless wall switch (on/off, cold climate, battery strength indicator)	HTI 1	\$ 116	Y	14	14	Y	Y
-----------	-------------------------------------------------------------------------------------------------	-------	--------	---	----	----	---	---

Touch Screen Remote

IFT-RC400	IntelliFire Touch black remote control, docking station and auxiliary control module (on/off, flame height, thermostat mode, fan control, child lock, cold climate, timer mode, hot indicator, lights, on-screen maintenance and troubleshooting notifications)	HTI 1	\$ 379	Y	Y	Y	Y	Y
-----------	-----------------------------------------------------------------------------------------------------------------------------------------------------------------------------------------------------------------------------------------------------------------	-------	--------	---	---	---	---	---



IntelliFire app

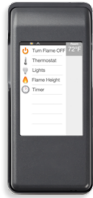

Touch Screen Remote

Venting Notes

Requires: LINK-DV30B, LINKSQB-DV30, LINKSQC-DV30, LINK-DV4-30B, LINKSQB-DV-30 or LINKSQC-DV4-30 flex liner kit. Refer to Venting section.

Trilliant Insert 35"

Includes:

- 24,500 - 35,000 BTU/Hour Input (NG)
- 24,500 - 35,000 BTU/Hour Input (LP)
- IntelliFire Touch Ignition System
- RC400 Remote Control
- GFK-160A Variable Fan
- Heat Exchanger Tubes
- Accent Lights
- Canyon Brown Brick Interior
- Decorative Brick Base
- Ceramic Glass
- Glowing Embers
- Battery Back Up
- Electrical Cord - 10' Left, X 7' Right
- Gas Flex Connector
- LP Conversion Kit



- Required to Complete - Sold Separately:**
- Front
 - Venting
 - Surround - Metal or Metal with cast trim

		Disc. Code	MSRP USD	004 IA	010 PA	014 CA	016 NC	EXP
TRILLIANT35IN	Trilliant large 35" direct vent gas insert with intellifire touch ignition system (NG)	MAJ 3	\$ 3,359	Y	Y	Y	14	N

Fronts - Non-Operable (Required to Complete)

Clean Screen

CSFI35BK	Clean 35" screen front - Black	MAJ 3	\$ 429	Y	Y	Y	14	Y
CSFI35NB	Clean 35" screen front - New Bronze	MAJ 3	\$ 459	Y	14	14	14	Y

Forged Arch

FA-TRI35-BK	Forged Arch 35" screen front - Black	MAJ 3	\$ 1,449	14	14	14	14	N
-------------	--------------------------------------	-------	----------	----	----	----	----	---

Inside Fit

INFIT-35-BK	Inside fit 35" screen front - Black	HTI 3	\$ 389	Y	Y	Y	14	Y
-------------	-------------------------------------	-------	--------	---	---	---	----	---

Mission Fullview

MFV-TRI35-BK	Mission Full View 35" screen front - Black	MAJ 3	\$ 559	14	14	14	14	Y
MFV-TRI35-NB	Mission Full View 35" screen front - New Bronze	MAJ 3	\$ 619	14	14	14	14	Y

Tuscan Arch

TA-TRI35-BK	Tuscan Arch 35" screen front - Black	MAJ 3	\$ 759	14	14	14	14	Y
TA-TRI35-NB	Tuscan Arch 35" screen front - New Bronze	MAJ 3	\$ 799	14	14	14	14	Y



Clean Screen



Inside Fit

Metal Surrounds (Required to Complete)

Surrounds - Small

MI35-4229-BK	Small 35" surround 42" x 29" - Black	HTI 3	\$ 399	Y	Y	Y	21	Y
MI35-4229-NB	Small 35" surround 42" x 29" - New Bronze	HTI 3	\$ 429	Y	Y	Y	14	Y

Surrounds - Medium										
MI35-4432D-BK	Medium 35" surround 44" x 32" x 2" deep - Black	HTI 3	\$ 419	14	14	Y	14	Y		
MI35-4432-BK	Medium 35" surround 44" x 32" - Black	HTI 3	\$ 419	Y	Y	Y	Y	Y		
MI35-4432-NB	Medium 35" surround 44" x 32" - New Bronze	HTI 3	\$ 459	14	Y	Y	14	Y		
Surrounds - Large										
MI35-4832-BK	Large 35" surround 48" x 32" - Black	HTI 3	\$ 449	Y	Y	Y	14	Y		
MI35-4832-NB	Large 35" surround 48" x 32" - New Bronze	HTI 3	\$ 479	14	14	14	14	Y		
Custom Surround										
MI35-5040CS-BK	On site 35" customizable surround - 50" w x 40" h (comes 4 sided with a 5" bottom, can be trimmed to make 3 sided)	HTI 3	\$ 499	Y	Y	Y	14	Y		
CUST-SRND-MI	Custom surround metal inserts (see custom surround order form for details)	HTI 3	\$ 839	14	14	21	14	Y		
Venting (Required to Complete)										
Gas Insert Venting - 30/30 Termination Kits										
LINK-DV4-30B	Direct vent insert kit - one 4 - liner, one 30 - liner, plus term cap components	HTI 1	\$ 549	Y	Y	Y	Y	Y		
LINK-DV30B	Direct vent insert kit - two 30 - liners, plus term cap components	HTI 1	\$ 649	Y	Y	Y	Y	Y		
LINKSQB-DV4-30	Direct vent insert kit - one 4 - liner, one 30 - liner, plus black term cap components	HTI 1	\$ 649	Y	Y	14	14	Y		
LINKSQB-DV30	Direct vent insert kit - two 30 - liners, plus black term cap components	HTI 1	\$ 729	Y	Y	Y	14	Y		
LINKSQC-DV30	Direct vent insert kit - two 30" liners, plus faux copper term cap components	HTI 1	\$ 789	Y	Y	Y	14	Y		
Liner Kit										
Glass Liner										
LINER-BK-35	Reflective Black Glass Liner 35" traditional units	HTI 3	\$ 559	Y	Y	Y	14	Y		
Control, remotes, wall switches										
IntelliFire app										
IFT-WFM	IntelliFire Wi-Fi Module that works with the IntelliFire iOS and Android app. Use to control all the features of your fireplace via a smart device. An RC400, RC450 or RC150 is required for thermostat control	HTI 1	\$ 219	Y	Y	Y	Y	Y		
Remote/Wall Switch/Wall Thermostat										
IFT-RC150	IntelliFire Touch white wireless wall switch (on/off, cold climate, battery strength indicator)	HTI 1	\$ 116	Y	14	14	Y	Y		
Touch Screen Remote										
IFT-RC400	IntelliFire Touch black remote control, docking station and auxiliary control module (on/off, flame height, thermostat mode, fan control, child lock, cold climate, timer mode, hot indicator, lights, on-screen maintenance and troubleshooting notifications)	HTI 1	\$ 379	Y	Y	Y	Y	Y		



IntelliFire app



Touch Screen Remote

Venting Notes

Requires: LINK-DV30B, LINKSQB-DV30, LINKSQC-DV30, LINK-DV4-30B, LINKSQB-DV-30 or LINKSQC-DV4-30 flex liner kit. Refer to Venting section.

Hearth & Home Technologies

Gas Logs - Log Set Option

Stocked Item/Lead Time

004=Mt. Pleasant RDC
010=Kutztown RDC
014=Sacramento RDC
016=Charlotte RDC

EXP=Factory Expedite Program

Page printed 2/1/2024 3:05:35 PM CST

Future pricing effective for shipments on or after 03/31/2024

* Please Contact Who You Purchase This Through for MSRP Pricing

Prices in USD

Non-stock and custom product cannot be cancelled.

Customer is responsible for freight for orders made outside of assigned RDC facility.

Campfire Gas Log Sets

Includes:

- Can operate with doors closed
- No visible controls
- Shut off valve
- Remote ready
- 18 & 24" - 10 fiber logs; 30" - 11 fiber log
- Glowing embers
- Flex connector
- Stainless steel burner
- Damper clamp
- Vermiculite
- CSA certified
- May not be operated in thermostat mode
- Remotes listed are for IPI controls only



No additional items required to complete.

		Disc. Code	MSRP USD	004 IA	010 PA	014 CA	016 NC	EXP
CFL-18LP-C	18" Campfire fiber gas log set with Stainless Steel Burner and hearth kit - 60,000 Btu/Hour Input (LP).	HTI 3	\$ 1,009	14	21	14	14	Y
CFL-18NG-C	18" Campfire fiber gas log set with Stainless Steel Burner and hearth kit - 60,000 Btu/Hour Input (NG).	HTI 3	\$ 1,009	14	14	14	14	Y
CFL-24LP-C	24" Campfire fiber gas log set with Stainless Steel Burner and hearth kit - 60,000 Btu/Hour Input (LP)	HTI 3	\$ 1,079	14	21	14	14	N
CFL-24NG-C	24" Campfire fiber gas log set with Stainless Steel Burner and hearth kit - 60,000 Btu/Hour Input (NG)	HTI 3	\$ 1,079	14	14	14	14	Y
CFL-30LP-C	30" Campfire fiber gas log set with Stainless Steel Burner and hearth kit - 60,000 Btu/Hour Input (LP)	HTI 3	\$ 1,159	14	21	14	14	N
CFL-30NG-C	30" Campfire fiber gas log set with Stainless Steel Burner and hearth kit - 60,000 Btu/Hour Input (NG)	HTI 3	\$ 1,159	14	21	14	14	Y
CFL-24NG-IPI	24" Campfire fiber gas log set with Stainless Steel Burner and hearth kit, IPI ignition - 60,000 Btu/Hour Input (NG)	HTI 3	\$ 1,179	14	21	14	14	Y
CFL-24LP-IPI	24" Campfire fiber gas log set with Stainless Steel Burner and hearth kit, IPI ignition - 60,000 Btu/Hour Input (LP)	HTI 3	\$ 1,179	14	21	14	14	Y

Control, remotes, wall switches

Millivolt/Standing Pilot Control, remotes, wall switches

RCB	Hand-held On/Off with battery receiver and wall cover plates.	HTI 1	\$ 189	Y	Y	Y	Y	Y
-----	---------------------------------------------------------------	-------	--------	---	---	---	---	---

Smart Stat Remote Control

SMART-STAT-HHT	Remote Control - IPI or SP (on/off, temp readout, thermostat mode, timer mode)	HTI 1	\$ 289	Y	Y	Y	Y	Y
----------------	--------------------------------------------------------------------------------	-------	--------	---	---	---	---	---

Duzy Series Gas Log Sets To be used with VDY burner/grate assembly only

Includes:

- Up to 17,000 BTUs of radiant heat
- Patented Natural Flame™ burner
- Factory assembled burner/grate with 5/8" grate
- Grate
- Valve
- Regulator
- Damper clamp
- Lava rock
- Rock wool embers
- Piezo igniter
- May not be operated in thermostat mode



Required to Complete - Sold Separately: • Requires hearth kit (below).

		Disc. Code	MSRP USD	004 IA	010 PA	014 CA	016 NC	EXP
VDY24/18D2A	4-piece Fiber Ceramic log set for VDY24/18. 18" rear log for narrow back fireplaces.	HTI 3	\$ 349	Y	Y	21	Y	Y
VDY24/18D3R	6-piece Refractory Cement log set for VDY24/18. 18" rear log for narrow back fireplaces.	HTI 3	\$ 419	Y	Y	14	Y	N
VDY30D2A	4-piece Fiber Ceramic log set for VDY30.	HTI 3	\$ 419	14	14	21	14	N
VDY24/18D5	8-piece Fiber Ceramic log set for VDY24/18. 18" rear log for narrow back fireplaces.	HTI 3	\$ 479	Y	Y	21	Y	Y
VDY30D3R	6-piece Refractory Cement log set for VDY30.	HTI 3	\$ 479	Y	21	14	14	Y
VDY30D5	8-piece Fiber Ceramic log set for VDY30.	HTI 3	\$ 589	14	14	21	14	Y

Gas Logs - Burner Option (Required to Complete)

Millivolt Control

VDY24/18PVP	24"/18" Vented Natural Flame On/Off Control Burner Assembly. L.P. 50,000 Btu.	HTI 3	\$ 969	Y	Y	35	Y	Y
VDY24/18NVP	24"/18" Vented Natural Flame On/Off Control Burner Assembly. N.G. 50,000 Btu.	HTI 3	\$ 969	Y	35	35	Y	Y
VDY30NVP	30" Vented Natural Flame On/Off Control Burner Assembly. N.G. 65,000 Btu.	HTI 3	\$ 1,059	Y	Y	35	Y	Y
VDY30PVP	30" Vented Natural Flame On/Off Control Burner Assembly. L.P. 65,000 Btu.	HTI 3	\$ 1,059	Y	35	35	35	Y

Options & Accessories

Options & Accessories

DV-RWA	Rock Wool, Carton of 12-4 oz. Bags.*	HTI 3	\$ 239	21	21	28	14	Y
--------	--------------------------------------	-------	--------	----	----	----	----	---

Options & Accessories

VR1000A	Volcanic Rock - Carton of 12 - 2 lb. Bags.*	HTI 3	\$ 289	8	21	14	14	Y
---------	---------------------------------------------	-------	--------	---	----	----	----	---

Control, remotes, wall switches

Millivolt/Standing Pilot Control, remotes, wall switches

RCB	Hand-held On/Off with battery receiver and wall cover plates.	HTI 1	\$ 189	Y	Y	Y	Y	Y
TSST	Touch screen hand-held thermostat with 6 hour, count down timer, large LCD screen, battery receiver and wall cover plates.	HTI 1	\$ 349	Y	Y	14	21	N

Smart Stat Remote Control

SMART-STAT-HHT	Remote Control - IPI or SP (on/off, temp readout, thermostat mode, timer mode)	HTI 1	\$ 289	Y	Y	Y	Y	Y
----------------	--------------------------------------------------------------------------------	-------	--------	---	---	---	---	---

Fireside Grand Oak Gas Log Sets

Includes:

- Matchlight
- Steel grate
- Platinum embers
- Glowing embers
- Vermiculite
- Sand (except LP)
- Lava granules
- Damper clamp
- Shut off valve
- Flex connector
- May not be operated in thermostat mode
- Remotes listed are for IPI controls only
- Log set sold separately



Required to Complete - Sold Separately: • Log set

		Disc. Code	MSRP USD	004 IA	010 PA	014 CA	016 NC	EXP
GO30MTCH-HK	30" Match Light Grand Oak Burner/Hearth Kit - 2 Tier	HTI 3	\$ 999	Y	14	14	21	N
GO24MTCH-HK	24" Match Light Grand Oak Burner/Hearth Kit - 2 Tier	HTI 3	\$ 999	Y	21	14	21	Y
GO24-IPI-NG-HK	24" IPI Grand Oak NG Burner/Hearth Kit - 2 Tier	HTI 3	\$ 1,289	Y	14	14	Y	Y
GO24-IPI-LP-HK	24" IPI Grand Oak LP Burner/Hearth Kit - 2 Tier	HTI 3	\$ 1,289	Y	21	21	21	Y
GO30-IPI-LP-HK	30" IPI Grand Oak LP Burner/Hearth Kit - 2 Tier	HTI 3	\$ 1,329	Y	21	14	14	Y
GO30-IPI-NG-HK	30" IPI Grand Oak NG Burner/Hearth Kit - 2 Tier	HTI 3	\$ 1,329	Y	14	14	14	N
GO318-IPI-LP-HK	18" IPI Grand Oak LP Burner/Hearth Kit - 3 Tier	HTI 3	\$ 1,359	21	21	21	21	Y
GO318-IPI-NG-HK	18" IPI Grand Oak NG Burner/Hearth Kit - 3 Tier	HTI 3	\$ 1,359	Y	21	14	21	Y
GO324-IPI-NG-HK	24" IPI Grand Oak NG Burner/Hearth Kit - 3 Tier	HTI 3	\$ 1,449	Y	14	14	14	N
GO324-IPI-LP-HK	24" IPI Grand Oak LP Burner/Hearth Kit - 3 Tier	HTI 3	\$ 1,449	Y	21	21	21	Y
GO330-IPI-LP-HK	30" IPI Grand Oak LP Burner/Hearth Kit - 3 Tier	HTI 3	\$ 1,499	Y	21	14	14	N
GO330-IPI-NG-HK	30" IPI Grand Oak NG Burner/Hearth Kit - 3 Tier	HTI 3	\$ 1,499	Y	21	21	14	N

Gas Logs - Log Set Option (Required to Complete)

Grand Oak Logs 24

GO24	24" Grand Oak Log Set - 11pcs, 2 Tier	HTI 3	\$ 429	Y	Y	14	Y	N
GO30	30" Grand Oak Log Set - 12pcs, 2 Tier	HTI 3	\$ 519	Y	21	14	Y	N

Grand Oak Logs 318

GO318	18" Grand Oak Log Set - 10pcs, 3 Tier	HTI 3	\$ 589	Y	21	14	21	N
-------	---------------------------------------	-------	--------	---	----	----	----	---

Grand Oak Logs 324

GO324	24" Grand Oak Log Set - 11pcs, 3 Tier	HTI 3	\$ 599	Y	14	14	Y	N
-------	---------------------------------------	-------	--------	---	----	----	---	---

Grand Oak Logs 330

GO330	30" Grand Oak Log Set - 12pcs, 3 Tier	HTI 3	\$ 669	Y	21	14	21	N
-------	---------------------------------------	-------	--------	---	----	----	----	---

Control, remotes, wall switches

Millivolt/Standing Pilot Control, remotes, wall switches

RCB	Hand-held On/Off with battery receiver and wall cover plates.	HTI 1	\$ 189	Y	Y	Y	Y	Y
-----	---------------------------------------------------------------	-------	--------	---	---	---	---	---

Smart Stat Remote Control

SMART-STAT-HHT	Remote Control - IPI or SP (on/off, temp readout, thermostat mode, timer mode)	HTI 1	\$ 289	Y	Y	Y	Y	Y
----------------	--------------------------------------------------------------------------------	-------	--------	---	---	---	---	---

Fireside Grand Oak Outdoor Gas Log Sets

Includes:

- 3-step burner kit
- IPI Ignition
- Steel grate
- Lava granules
- Reinforced cement
- Damper clamp
- Shut off valve
- Flex connector
- Stainless steel burner/grate assembly
- Log set sold separately



Required to Complete - Sold Separately: • Log set

		Disc. Code	MSRP USD	004 IA	010 PA	014 CA	016 NC	EXP
OGO324-MTCH-HK	24" Match Light Outdoor Grand Oaks Burner/Hearth Kit - 3 Tier (NG only)	HTI 3	\$ 1,499	21	14	28	21	Y
OGO324-IPILP-HK	24" IPI Outdoor Grand Oaks LP Burner/Hearth Kit - 3 Tier	HTI 3	\$ 1,689	21	21	21	21	Y
OGO324-IPING-HK	24" IPI Outdoor Grand Oaks NG Burner/Hearth Kit - 3 Tier	HTI 3	\$ 1,689	Y	21	14	21	Y

Gas Logs - Log Set Option (Required to Complete)

Grand Oak Logs 324

GO324	24" Grand Oak Log Set - 11pcs, 3 Tier	HTI 3	\$ 599	Y	14	14	Y	N
-------	---------------------------------------	-------	--------	---	----	----	---	---

Fireside Realwood Gas Log Sets

Includes:

- 8 refractory logs
- Reinforced cement



No additional items required to complete.

		Disc. Code	MSRP USD	004 IA	010 PA	014 CA	016 NC	EXP
FRW118	18" Fireside Realwood refractory cement log set (order hearth kit separately)	HTI 3	\$ 189	Y	21	Y	21	N
FRW124	24" Fireside Realwood refractory cement log set (order hearth kit separately)	HTI 3	\$ 229	Y	14	Y	Y	N

Gas Logs - Burner Option (Required to Complete)

Match Light Hearth Kit

MHK24NG	Hearth Kits Sand Pan Burners for Single-Sided Fireplaces 24" matchlight hearth kit - 74,000 Btu/Hour Input (NG only)	HTI 3	\$ 319	Y	14	Y	21	N
MHK18NG	Hearth Kits Sand Pan Burners for Single-Sided Fireplaces 18" matchlight hearth kit - 60,000 Btu/Hour Input (NG only)	HTI 3	\$ 259	Y	28	Y	28	N

Safety Pilot Hearth Kit

SP24NG	Hearth Kits Sand Pan Burners for Single-Sided Fireplaces 24" safety pilot hearth kit - 67,000 Btu/Hour Input (NG)	HTI 3	\$ 509	Y	14	14	Y	N
SP24LP	Hearth Kits Sand Pan Burners for Single-Sided Fireplaces 24" safety pilot hearth kit - 40,000 Btu/Hour Input (LP)	HTI 3	\$ 509	Y	14	14	21	N
SP18NG	Hearth Kits Sand Pan Burners for Single-Sided Fireplaces 18" safety pilot hearth kit - 60,000 Btu/Hour Input (NG)	HTI 3	\$ 499	Y	14	14	14	N
SP18LP	Hearth Kits Sand Pan Burners for Single-Sided Fireplaces 18" safety pilot hearth kit - 40,000 Btu/Hour Input (LP)	HTI 3	\$ 499	Y	14	14	21	N

Remote Kits for SP Units

Gas Log Controls

LMK-SP	Left side mounting kit - safety pilot	HTI 3	\$ 82	14	21	14	21	N
REM-KIT	On/off hi/low remote control and solenoid kit	HTI 3	\$ 419	Y	Y	14	Y	N

Fireside Realwood Outdoor Gas Log Sets

Includes:

- 62,000 Btu/Hr Input NG
- Match Light (NG), Safety Pilot (LP)
- Pan burner kit
- Stainless steel grate
- Lava rock
- Damper clamp
- Flex connector
- Shut off valve (ODSP-18LP & ODSP-24LP)



Required to Complete - Sold Separately: • Fireside Realwood log set (FRW118 or FRW124) required to complete.

		Disc. Code	MSRP USD	004 IA	010 PA	014 CA	016 NC	EXP
OD-18NG	18" matchlight hearth kit for outdoor fireplaces - 62,000 Btu/Hour Input (NG only)	HTI 3	\$ 839	21	21	21	21	N
ODSP-18LP	18" safety pilot hearth kit for outdoor fireplaces - 55,000 Btu/Hour Input LP (Note: Controls are located on the right and may offset the unit in the fireplace. Choose hearth size accordingly. See installation manual for hearth dimensions.)	HTI 3	\$ 969	21	21	28	21	N
OD-24NG	24" matchlight hearth kit for outdoor fireplaces - 69,000 Btu/Hour Input (NG only)	HTI 3	\$ 1,009	Y	21	21	21	N
ODSP-24LP	24" safety pilot hearth kit for outdoor fireplaces - 61,000 Btu/Hour input LP (Note: Controls are located on the right and may offset the unit in the fireplace. Choose hearth size accordingly. See installation manual for hearth dimensions.)	HTI 3	\$ 1,079	21	21	21	21	N

Gas Logs - Log Set Option (Required to Complete)

Fireside Realwood Gas Log Sets

FRW118	18" Fireside Realwood refractory cement log set (order hearth kit separately)	HTI 3	\$ 189	Y	21	Y	21	N
FRW124	24" Fireside Realwood refractory cement log set (order hearth kit separately)	HTI 3	\$ 229	Y	14	Y	Y	N



Fireside Realwood Gas Log Sets

Remote Kits for SP Units

Gas Log Controls

LMK-SP	Left side mounting kit - safety pilot	HTI 3	\$ 82	14	21	14	21	N
--------	---------------------------------------	-------	-------	----	----	----	----	---

Fireside Supreme Oak Gas Logs

Includes:

- 12 refractory logs
- Reinforced cement



No additional items required to complete.

		Disc. Code	MSRP USD	004 IA	010 PA	014 CA	016 NC	EXP
FSO18	18" Fireside Supreme Oak refractory cement log set (order hearth kit separately)	HTI 3	\$ 489	Y	14	14	21	N
FSO24	24" Fireside Supreme Oak refractory cement log set (order hearth kit separately)	HTI 3	\$ 529	Y	14	21	21	N
FSO30	30" Fireside Supreme Oak refractory cement log set (order hearth kit separately)	HTI 3	\$ 569	Y	14	14	21	N

Gas Logs - Burner Option

Match Light Hearth Kit

MHK18NG	Hearth Kits Sand Pan Burners for Single-Sided Fireplaces 18" matchlight hearth kit - 60,000 Btu/Hour Input (NG only)	HTI 3	\$ 259	Y	28	Y	28	N
MHK24NG	Hearth Kits Sand Pan Burners for Single-Sided Fireplaces 24" matchlight hearth kit - 74,000 Btu/Hour Input (NG only)	HTI 3	\$ 319	Y	14	Y	21	N

Safety Pilot Hearth Kit

SP18NG	Hearth Kits Sand Pan Burners for Single-Sided Fireplaces 18" safety pilot hearth kit - 60,000 Btu/Hour Input (NG)	HTI 3	\$ 499	Y	14	14	14	N
SP18LP	Hearth Kits Sand Pan Burners for Single-Sided Fireplaces 18" safety pilot hearth kit - 40,000 Btu/Hour Input (LP)	HTI 3	\$ 499	Y	14	14	21	N
SP24NG	Hearth Kits Sand Pan Burners for Single-Sided Fireplaces 24" safety pilot hearth kit - 67,000 Btu/Hour Input (NG)	HTI 3	\$ 509	Y	14	14	Y	N
SP24LP	Hearth Kits Sand Pan Burners for Single-Sided Fireplaces 24" safety pilot hearth kit - 40,000 Btu/Hour Input (LP)	HTI 3	\$ 509	Y	14	14	21	N
SP30NG	30" safety pilot hearth kit - 80,000 Btu/Hour Input (NG)	HTI 3	\$ 529	21	21	21	21	N
SP30LP	30" safety pilot hearth kit - 60,000 Btu/Hour Input (LP)	HTI 3	\$ 529	21	21	21	14	N

Remote Kits for SP Units

Gas Log Controls

LMK-SP	Left side mounting kit - safety pilot	HTI 3	\$ 82	14	21	14	21	N
REM-KIT	On/off hi/low remote control and solenoid kit	HTI 3	\$ 419	Y	Y	14	Y	N

Fireside Supreme Oak See-Through Gas Logs

Includes:

- 19 refractory logs
- Reinforced cement



No additional items required to complete.

		Disc. Code	MSRP USD	004 IA	010 PA	014 CA	016 NC	EXP
STFSO18	18" Fireside Supreme Oak gas log set for See-Through fireplace (order hearth kit separately)	HTI 3	\$ 569	Y	14	21	14	N
STFSO24	24" Fireside Supreme Oak gas log set for See-Through fireplace (order hearth kit separately)	HTI 3	\$ 589	Y	14	21	14	N

Gas Logs - Burner Option

See-Through Hearth Kit Safety Pilot

STSP18NG	18" safety pilot hearth kit for see-through fireplaces - 60,000 Btu/Hour Input (NG)	HTI 3	\$ 789	Y	14	21	21	N
STSP18LP	18" safety pilot hearth kit for see-through fireplaces - 65,000 Btu/Hour Input (LP)	HTI 3	\$ 789	21	14	21	14	N
STSP24NG	24" safety pilot hearth kit for see-through fireplaces - 75,000 Btu/Hour Input (NG)	HTI 3	\$ 819	Y	14	14	21	N
STSP24LP	24" safety pilot hearth kit for see-through fireplaces - 69,000 Btu/Hour Input (LP)	HTI 3	\$ 819	21	14	21	14	N

Remote Kits for SP Units

Gas Log Controls

LMK-SP	Left side mounting kit - safety pilot	HTI 3	\$ 82	14	21	14	21	N
REM-KIT	On/off hi/low remote control and solenoid kit	HTI 3	\$ 419	Y	Y	14	Y	N

Gas Logs - Burner Option (OD)

Includes:

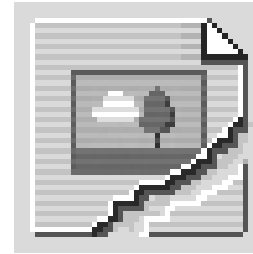

No additional items required to complete.

		Disc. Code	MSRP USD	004 IA	010 PA	014 CA	016 NC	EXP
LUM-OD-NM	Lumonessen Outdoor Burner: Manual Ignition, NG: 19,000 MIN - 38,000 MAX BTUs	HTI 3	\$ 799	Y	35	Y	Y	Y
LUM-OD-PM	Lumonessen Outdoor Burner: Manual Ignition, LP: 31,000 MIN - 38,000 MAX BTUs	HTI 3	\$ 799	Y	35	35	Y	Y

Gas Logs - Log Set Option (Required to Complete)

Mezmer

MZMR-18	18" Mezmer Log Set	HTI 1	\$ 209	Y	Y	14	Y	Y
MZMR-24	24" Mezmer Log Set	HTI 1	\$ 219	Y	Y	Y	Y	Y
MZMR-30	30" Mezmer Log Set	HTI 1	\$ 249	Y	14	14	Y	Y

Mezmer Split

MZMRSP-18	18" Mezmer Split Log Set	HTI 1	\$ 209	Y	14	14	Y	Y
MZMRSP-24	24" Mezmer Split Log Set	HTI 1	\$ 219	Y	Y	14	Y	Y
MZMRSP-30	30" Mezmer Split Log Set	HTI 1	\$ 249	Y	14	14	Y	Y

Mountain Oak

MTNOK-18	18" Mountain Oak Log Set	HTI 1	\$ 209	Y	Y	14	Y	Y
MTNOK-24	24" Mountain Oak Log Set	HTI 1	\$ 219	Y	Y	Y	Y	Y
MTNOK-30	30" Mountain Oak Log Set	HTI 1	\$ 249	Y	21	21	Y	Y



Mezmer



Mezmer Split



Mountain Oak

Hearth & Home Technologies

Power Vent

Stocked Item/Lead Time
 004=Mt. Pleasant RDC
 010=Kutztown RDC
 014=Sacramento RDC
 016=Charlotte RDC
 EXP=Factory Expedite Program

Prices in USD

Page printed 2/1/2024 3:05:35 PM CST

* Please Contact Who You Purchase This Through for MSRP Pricing

Non-stock and custom product cannot be cancelled.

Customer is responsible for freight for orders made outside of assigned RDC facility.

PVV-SLEEVE

		Disc. Code	MSRP USD	004 IA	010 PA	014 CA	016 NC	EXP
PVV-SLEEVE-12	12" long sleeve for use with PVV-SLP to protect the wire harness; 8" diameter, uses DVP flashing for roof terminations	HTI 1	\$ 75	Y	Y	Y	Y	Y
PVV-SLEEVE-48	48" long sleeve for use with PVV-SLP to protect the wire harness; 8" diameter, uses DVP flashing for roof terminations	HTI 1	\$ 127	Y	Y	Y	Y	Y

PVV-SLP

		Disc. Code	MSRP USD	004 IA	010 PA	014 CA	016 NC	EXP
PVV-SLP	Vertical Power Vent, includes a DVP storm collar. May require PV-IPI-CK, refer to venting notes on the fireplace price page. PVV-SLEEVE-12 or PVV-SLEEVE-48 required to complete, wire harness required to complete.	HTI 1	\$ 1,761	Y	Y	Y	Y	Y

PVLP-SLP - Low Profile Power Vent

		Disc. Code	MSRP USD	004 IA	010 PA	014 CA	016 NC	EXP
PVLP-SLP	Low Profile Power Vent, may require PV-IPI-CK kit. Refer to Venting Notes on the fireplace price page. Wire harness required to complete.	HTI 1	\$ 1,761	Y	Y	Y	Y	Y

Power Vent

		Disc. Code	MSRP USD	004 IA	010 PA	014 CA	016 NC	EXP
PVI-SLP-B	Inline Power Vent, may require PV-IPI-CK kit. Refer to Venting Notes on the fireplace price page. Wire harness required to complete.	HTI 1	\$ 1,761	Y	Y	Y	Y	N

Powervent

		Disc. Code	MSRP USD	004 IA	010 PA	014 CA	016 NC	EXP
RS12	External Mount Powervent	STL null	*					N
RSIF160	Inline Powervent	STL null	*					N
RS14	External Mount Powervent	STL null	*					N
RSIF180	Inline Powervent	STL null	*					N

PVI-SLP - Term Kits and Acc

		Disc.	MSRP	004	010	014	016	EXP
		Code	USD	IA	PA	CA	NC	
LPC-BEK	Brick kit	HTI 1	\$ 93	8	21	14	14	N
SLP-LPC	Low profile cap	HTI 1	\$ 648	8	21	14	14	Y

PVLP-SLP - Accessories

		Disc.	MSRP	004	010	014	016	EXP
		Code	USD	IA	PA	CA	NC	
PVLP-HS	Low Profile Power Vent Heat Shield (optional)	HTI 1	\$ 74	8	21	14	14	Y
PVLP-BEK	Brick extension kit for Low Profile Power Vent	HTI 1	\$ 85	Y	Y	Y	14	Y
PV-IPI-CK	Power Vent conversion kit required for IntelliFire and IntelliFire Plus Gas Fireplaces	HTI 1	\$ 372	Y	Y	Y	Y	Y

Hearth & Home Technologies

Wire Harness

Stocked Item/Lead Time
 004=Mt. Pleasant RDC
 010=Kutztown RDC
 014=Sacramento RDC
 016=Charlotte RDC

 EXP=Factory Expedite Program

Page printed 2/1/2024 3:05:35 PM CST
 * Please Contact Who You Purchase This Through for MSRP Pricing

Prices in USD
 Non-stock and custom product cannot be cancelled.
 Customer is responsible for freight for orders made outside of assigned RDC facility.

Power Vent - Wire Harness

		Disc. Code	MSRP USD	004 IA	010 PA	014 CA	016 NC	EXP
PVI-WH10	10 foot Power Vent Wire Harness for use with PVLP-SLP, PVV-SLP and PVI-SLP-B	HTI 1	\$ 130	Y	21	Y	Y	Y
PVI-WH20	20 foot Power Vent Wire Harness for use with PVLP-SLP, PVV-SLP and PVI-SLP-B	HTI 1	\$ 181	Y	Y	Y	Y	Y
PVI-WH40	40 foot Power Vent Wire Harness for use with PVLP-SLP, PVV-SLP and PVI-SLP-B	HTI 1	\$ 231	Y	Y	Y	Y	Y
PVI-WH60	60 foot Power Vent Wire Harness for use with PVLP-SLP, PVV-SLP and PVI-SLP-B	HTI 1	\$ 283	Y	Y	Y	Y	Y
PVI-WH80	80 foot Power Vent Wire Harness for use with PVLP-SLP, PVV-SLP and PVI-SLP-B	HTI 1	\$ 321	Y	21	14	14	Y
PVI-WH100	100 foot Power Vent Wire Harness for use with PVLP-SLP, PVV-SLP and PVI-SLP-B	HTI 1	\$ 372	14	21	14	14	Y
PVMW100	Wire harness for PVLP-SLP Power Vent installed on Signature Command fireplace, 100 ft	VCG 1	\$ 710	8	21	14	14	Y

Hearth & Home
Technologies

Venting

Stocked Item/Lead Time

004=Mt. Pleasant RDC
010=Kutztown RDC
014=Sacramento RDC
016=Charlotte RDCEXP=Factory Expedite
Program

Page printed 2/1/2024 3:05:35 PM CST

* Please Contact Who You Purchase This Through for MSRP Pricing

Prices in USD

Non-stock and custom product cannot be cancelled.

Customer is responsible for freight for orders made outside of assigned RDC facility.

Brick Extension Kit

		Disc. Code	MSRP USD	004 IA	010 PA	014 CA	016 NC	EXP
HEAT-OUT-BEK	Exterior Heat-Zone brick extension kit	HTI 1	\$ 71	8	21	21	14	Y

Decorative Termination Caps/Shrouds for Wood and Gas Units - Termination

		Disc. Code	MSRP USD	004 IA	010 PA	014 CA	016 NC	EXP
CT-3A-B	Chimney adapter for use with DTS & DTO caps on SL300 pipe	HTI 1	\$ 189	8	21	14	14	Y
CT-11A-B	Chimney adapter for use with DTS & DTO caps on SL1100 pipe	HTI 1	\$ 215	Y	21	14	14	Y
CT-14A	Chimney adapter for use with DTS & DTO caps on 14" DuraChimney	HTI 1	\$ 254	8	21	14	14	Y
LDS33	Vertical 3' x 3' (915mm x 915mm) field adjustable, UL listed decorative shroud for use with TS and TR termination caps	HTI 1	\$ 381	8	21	14	14	Y
LDS46	Vertical 4' x 6' (1220mm x 1830mm) field adjustable, UL listed decorative shroud for use with TS and TR termination caps	HTI 1	\$ 720	8	Y	14	14	Y
LDS46-M	40 piece multi-pack of UL listed vertical shroud "corner posts" for field fabrication of shroud	HTI 1	\$ 865	Y	21	14	Y	Y
DTS134-CP	Decorative Termination Square 34" - faux copper (Adapter required for wood)	HTI 1	\$ 1,627	Y	21	14	Y	N
DTO134-CP	Decorative Termination Octagon 34" - faux copper (Adapter required for wood)	HTI 1	\$ 1,627	Y	14	14	14	N
DTS134-BK	Decorative Termination Square 34" - Black (Adapter required for wood)	HTI 1	\$ 1,627	Y	14	14	Y	N
DTO134-BK	Decorative Termination Octagon 34" - black (adapter required for wood pipe)	HTI 1	\$ 1,627	8	21	14	14	Y
DTS146-BK	Decorative Termination Square 46" - Black (Adapter required for wood)	HTI 1	\$ 1,792	8	21	14	14	N
DTO146-CP	Decorative Termination Octagon 46" - faux copper (Adapter required for wood)	HTI 1	\$ 1,792	Y	21	14	Y	N
DTO146-BK	Decorative Termination Octagon 46" - Black (Adapter required for wood)	HTI 1	\$ 1,792	Y	14	14	14	N
DTS146-CP	Decorative Termination Square 46" - faux copper (Adapter required for wood)	HTI 1	\$ 1,792	Y	21	14	Y	N

Decorative Termination for Wood Units - Termination

		Disc. Code	MSRP USD	004 IA	010 PA	014 CA	016 NC	EXP
TR-TVK	Round termination top adaptor kit for shrouds	HTI 1	\$ 118	Y	Y	Y	14	Y

8" DuraPlus - Adapter/Increaser/Tee

		Disc. Code	MSRP USD	004 IA	010 PA	014 CA	016 NC	EXP
DV-8DP-TSS	8" DuraPlus tee w/cap (SS)	HTI 5	\$ 817	35	35	28	35	N

8" DuraPlus - Anchor

		Disc. Code	MSRP USD	004 IA	010 PA	014 CA	016 NC	EXP
DV-8DP-BP	8" DuraPlus base plate	HTI 5	\$ 161	Y	14	28	14	N

8" DuraPlus - Firestop/Straps/Support

		Disc. Code	MSRP USD	004 IA	010 PA	014 CA	016 NC	EXP
DV-8DP-WT	8" DuraPlus wall thimble	HTI 5	\$ 214	35	35	28	35	N
DV-8DP-WTSS	8" DuraPlus wall thimble (SS)	HTI 5	\$ 248	35	35	28	35	N
DV-8DP-TSB	8" DuraPlus tee support bracket (GA)	HTI 5	\$ 269	35	35	28	35	N
DV-8DP-CS11	8X11 DuraPlus square ceiling support	HTI 5	\$ 279	35	35	28	35	N
DV-8DP-TSBSS	8" DuraPlus tee support bracket (SS)	HTI 5	\$ 424	35	35	28	35	N
DV-8DP-CS36	8X36 DuraPlus square ceiling support	HTI 5	\$ 470	35	35	28	35	N

6" DuraPlus

		Disc. Code	MSRP USD	004 IA	010 PA	014 CA	016 NC	EXP
DV-6DP-WS	6" DuraPlus wall strap	HTI 5	\$ 67	35	35	28	35	N
DV-6DP-ES	6" DuraPlus elbow strap	HTI 5	\$ 81	35	35	28	35	N
DV-6DP-WSSS	6" DuraPlus wall strap - stainless steel	HTI 5	\$ 84	35	35	28	35	N
DV-6DP-BP	6" DuraPlus base plate	HTI 5	\$ 110	35	35	28	35	N
DV-6DP-09	6x9 DuraPlus pipe	HTI 5	\$ 160	35	35	28	35	N
DV-6DP-FRS	6" DuraPlus firestop radiation shield	HTI 5	\$ 161	35	35	28	35	N
DV-6DP-WT	6" DuraPlus wall thimble	HTI 5	\$ 166	35	35	28	35	N
DV-6DP-IS	6" DuraPlus attic insulation shield	HTI 5	\$ 180	35	35	28	35	N
DV-6DP-CCS48	6x48 DuraPlus close clearance shield	HTI 5	\$ 197	35	35	28	35	N
DV-6DP-TSB	6" DuraPlus tee support bracket	HTI 5	\$ 217	35	35	28	35	N
DV-6DP-RCS	6" DuraPlus RD ceiling support box	HTI 5	\$ 264	35	35	28	35	N
DV-6DP-CCS36	6x36 DuraPlus close clearance shield	HTI 5	\$ 301	35	35	28	35	N
DV-6DP-F12DSA	6" DuraPlus DSA flashing 7/12-12/12	HTI 5	\$ 358	35	35	28	35	N
DV-6DP-TSBSS	6" DuraPlus tee support bracket - stainless steel	HTI 5	\$ 424	35	35	28	35	N
DV-6DP-CS36	6x36 DuraPlus square ceiling support box	HTI 5	\$ 480	35	35	28	35	N
DV-6DP-T	6" DuraPlus tee with cap	HTI 5	\$ 515	35	35	28	35	N
DV-6DP-F24	6" DuraPlus flashing 19/12-24/12	HTI 5	\$ 545	35	35	28	35	N
DV-6DP-TSS	6" DuraPlus tee with cap - stainless steel	HTI 5	\$ 575	35	35	28	35	N
DV-6DP-E15	6" DuraPlus 15 Degree elbow kit	HTI 5	\$ 638	35	35	28	35	N
DV-6DP-F18	6" DuraPlus 13/12-18/12	HTI 5	\$ 901	35	35	28	35	N
DV-6DP-KMFG	6" DuraPlus multi-fuel home kit	HTI 5	\$ 1,296	35	35	28	35	N
DV-6DP-CCS60	6x60 DuraPlus close clearance shield	HTI 5	\$ 1,585	35	35	28	35	N

5" B-Vent Components - Elbow

		Disc. Code	MSRP USD	004 IA	010 PA	014 CA	016 NC	EXP
DV-5BVL45	5BVL45 - 45/60 Degree Adjustable Elbow	HTI 5	\$ 58	35	35	28	35	Y
DV-5BVL90	5BVL90 - 90 Degree Adjustable Elbow	HTI 5	\$ 105	35	35	28	35	Y

5" B-Vent Components - Firestop/Straps/Support

		Disc. Code	MSRP USD	004 IA	010 PA	014 CA	016 NC	EXP
DV-5BVFS	5BVFS - Firestop Spacer	HTI 5	\$ 19	35	35	28	35	Y
DV-5BVS	Support Assembly	HTI 5	\$ 34	35	35	28	35	Y

5" B-Vent Components - Shield/Flashing/Collars

		Disc. Code	MSRP USD	004 IA	010 PA	014 CA	016 NC	EXP
DV-5BVSC	5BVSC - Storm Collar	HTI 5	\$ 18	35	35	28	35	Y
DV-5BVFF	5BVFF - Tall Cone Flat Flashing	HTI 5	\$ 79	35	35	28	35	Y
DV-5BVFSR	5BVFSR - Steep Roof Flashing	HTI 5	\$ 90	35	35	28	35	Y
DV-5BVIS	Attic Insulation Shield 5" - 6"	HTI 5	\$ 183	35	35	28	35	Y

5" B-Vent Components - Straight Section

		Disc. Code	MSRP USD	004 IA	010 PA	014 CA	016 NC	EXP
DV-5BV06	5BV06 -6" Length Round Rigid Pipe	HTI 5	\$ 37	35	14	28	14	Y
DV-5BV12	5BV12 - 12" Length Round Rigid Pipe	HTI 5	\$ 38	35	35	28	35	Y
DV-5BV18	5BV18 - 18" Length Round Rigid Pipe	HTI 5	\$ 44	35	35	28	35	Y
DV-5BVAF	5" Universal Female Adapter GV to BV (If you need to connect to the female (inlet) end of Model GV pipe)	HTI 5	\$ 46	35	35	28	35	Y
DV-6BVAF	6" Universal Female Adapter GV to BV (If you need to connect to the female (inlet) end of Model GV pipe)	HTI 5	\$ 47	21	14	28	14	Y
DV-5BV12A	5BV12A -12" Length Round Adjustable Pipe	HTI 5	\$ 49	35	35	28	35	Y
DV-5BV24	5BV24 - 24" Length Round Rigid Pipe	HTI 5	\$ 58	Y	35	28	35	Y
DV-5BV48	5BV48 - 48" Length Round Rigid Pipe	HTI 5	\$ 100	35	35	28	35	Y
DV-5BV60	5BV60 - 60" Length Round Rigid Pipe	HTI 5	\$ 118	35	35	28	35	Y

5" B-Vent Termination - Termination

		Disc. Code	MSRP USD	004 IA	010 PA	014 CA	016 NC	EXP
DV-5BVDC	5BVDC - DuraCap	HTI 5	\$ 57	35	35	28	35	Y
DV-5BVVTH	5BVVTH - High-Wind Cap	HTI 5	\$ 63	35	35	28	35	Y

6" B-Vent Components - Adapter/Increaser/Tee

		Disc. Code	MSRP USD	004 IA	010 PA	014 CA	016 NC	EXP
DV-6BVC	6BVC - Draft Hood Connector	HTI 5	\$ 38	35	35	28	35	Y
DV-6BV36	6X36 LENGTH B-VENT	HTI 5	\$ 90	Y	14	28	Y	Y

6" B-Vent Components - Elbow

		Disc. Code	MSRP USD	004 IA	010 PA	014 CA	016 NC	EXP
DV-6BVL45	6BVL45 - 45/60 Degree Adjustable Elbow	HTI 5	\$ 70	Y	14	28	Y	Y
DV-6BVL90	6BVL90 - 90 Degree Adjustable Elbow	HTI 5	\$ 121	Y	14	Y	Y	Y

6" B-Vent Components - Firestop/Straps/Support

		Disc. Code	MSRP USD	004 IA	010 PA	014 CA	016 NC	EXP
DV-6BVFS	6BVFS - Firestop Spacer	HTI 5	\$ 19	Y	14	Y	Y	Y
DV-6BVS	6BVS - Gas Vent Roof Support	HTI 5	\$ 36	35	35	28	35	Y

6" B-Vent Components - Shield/Flashing/Collars

		Disc. Code	MSRP USD	004 IA	010 PA	014 CA	016 NC	EXP
DV-6BVF	6BVF - Adjustable Roof Flashing	HTI 5	\$ 68	Y	14	Y	14	N
DV-6BVFSR	6BVFSR - Steep Roof Flashing	HTI 5	\$ 116	Y	14	28	Y	Y
DV-6BVFDSA	6BVFDSA - 6" DSA Roof Flashing	HTI 5	\$ 132	35	35	Y	35	Y

6" B-Vent Components - Straight Section

		Disc. Code	MSRP USD	004 IA	010 PA	014 CA	016 NC	EXP
DV-5BVAM	5" Universal Male Adapter GV to BV (If you need to connect to the male (outlet) end of Model GV pipe)	HTI 5	\$ 42	35	35	28	35	Y
DV-6BV06	6BVDV-6 - 6" Length Round Rigid Pipe	HTI 5	\$ 43	Y	14	28	Y	Y
DV-6BV12	6BV12 - 12" Length Round Rigid Pipe	HTI 5	\$ 44	Y	14	28	Y	Y
DV-6BV18	6BV18 - 18" Length Round Rigid Pipe	HTI 5	\$ 50	Y	14	28	Y	Y
DV-6BV12A	6BV12A - 12" Length Round Adjustable Pipe	HTI 5	\$ 53	Y	14	28	Y	Y
DV-6BV24	6BV24 - 24" Length Round Rigid Pipe	HTI 5	\$ 70	Y	14	28	Y	Y
DV-6BV48	6BV48 - 48" Length Round Rigid Pipe	HTI 5	\$ 116	Y	14	28	Y	Y
DV-6BV60	6BV60 - 60" Length Round Rigid Pipe	HTI 5	\$ 136	Y	14	28	Y	Y
DV-8BVAF	8" Universal Female Adapter GV to BV (If you need to connect to the female (inlet) end of Model GV pipe)	HTI 5	\$ 180	35	35	28	35	Y

6" B-Vent Terminations - Termination

		Disc. Code	MSRP USD	004 IA	010 PA	014 CA	016 NC	EXP
DV-6BVDC	6BVDC - DuraCap	HTI 5	\$ 71	Y	14	28	14	Y
DV-6BVVTH	6BVVTH - High-Wind Cap	HTI 5	\$ 81	Y	14	28	Y	Y

6" B-Vent Terminations - Shield/Flashing/Coll

		Disc. Code	MSRP USD	004 IA	010 PA	014 CA	016 NC	EXP
DV-6BVSC	6BVSC - Storm Collar	HTI 5	\$ 19	Y	14	28	Y	Y

6" B-vent Quick Grip Firestop/Support

		Disc. Code	MSRP USD	004 IA	010 PA	014 CA	016 NC	EXP
DV-6BVFSPU	6" B-vent Quick Grip Firestop/Support	HTI 5	\$ 79	35	35	28	35	Y

6" B-vent Wall Support/Band Assembly

		Disc. Code	MSRP USD	004 IA	010 PA	014 CA	016 NC	EXP
DV-6BVWSB	6" B-vent Wall Support/Band Assembly	HTI 5	\$ 103	35	35	28	35	Y

8" B-Vent Components - Elbow

		Disc. Code	MSRP USD	004 IA	010 PA	014 CA	016 NC	EXP
DV-8BVVS	SQUARE FIRESTOP SUPPORT	HTI 5	\$ 85	35	35	28	35	Y

8" B-Vent Components - Elbow

		Disc. Code	MSRP USD	004 IA	010 PA	014 CA	016 NC	EXP
DV-8BVL45	45° Adjustable Elbow	HTI 5	\$ 118	Y	Y	Y	14	Y
DV-8BVL90	90° Adjustable Elbow	HTI 5	\$ 185	Y	14	Y	14	Y

8" B-vent Wall Support/Band Assembly

		Disc. Code	MSRP USD	004 IA	010 PA	014 CA	016 NC	EXP
DV-8BVWSB	8" B-vent Wall Support/Band Assembly	HTI 0	\$ 123	35	35	28	35	Y

8" B-Vent Components - Termination

		Disc. Code	MSRP USD	004 IA	010 PA	014 CA	016 NC	EXP
DV-8BVVTH	High-Wind Cap	HTI 5	\$ 126	35	35	28	35	Y

8" B-Vent Components - Firestop/Straps/Support

		Disc. Code	MSRP USD	004 IA	010 PA	014 CA	016 NC	EXP
DV-8BVWT	Wall Thimble	HTI 5	\$ 84	Y	14	28	14	Y

8" B-Vent Components - Shield/Flashing/Collars

		Disc. Code	MSRP USD	004 IA	010 PA	014 CA	016 NC	EXP
DV-8BVSC	Storm Collar	HTI 5	\$ 22	Y	14	28	14	Y
DV-8BVFS	Firestop Spacer	HTI 5	\$ 36	Y	14	Y	14	Y
DV-8BVF	Adjustable Roof Flashing	HTI 5	\$ 90	35	35	Y	35	Y
DV-8BVFF	Tall Cone Flat Flashing	HTI 5	\$ 123	35	35	28	35	Y
DV-8BVFSR	Steep Roof Flashing	HTI 5	\$ 180	Y	14	Y	14	Y
DV-7BVIS	Attic Insulation Shield 7" - 8"	HTI 5	\$ 244	Y	14	28	14	Y

8" B-Vent Components - Elbow

		Disc. Code	MSRP USD	004 IA	010 PA	014 CA	016 NC	EXP
DV-6BVAM	6" Universal Male Adapter GV to BV (If you need to connect to the male (outlet) end of Model GV pipe)	HTI 5	\$ 53	35	35	28	35	Y
DV-8BV12	12" Length Round Rigid Pipe	HTI 5	\$ 72	Y	14	Y	14	Y
DV-8BV18	18" Length Round Rigid Pipe	HTI 5	\$ 81	Y	14	28	14	Y
DV-8BV12A	12" Length Round Adjustable Pipe	HTI 5	\$ 81	Y	14	Y	14	Y
DV-8BV24	24" Length Round Rigid Pipe	HTI 5	\$ 115	Y	14	28	14	Y
DV-8BVAM	8" Universal Male Adapter GV to BV (If you need to connect to the male (outlet) end of Model GV pipe)	HTI 5	\$ 120	35	35	28	35	Y
DV-8BV36	36" Length Round Rigid Pipe	HTI 5	\$ 146	Y	14	28	14	Y
DV-8BV48	48" Length Round Rigid Pipe	HTI 5	\$ 199	Y	14	28	14	Y
DV-8BV60	60" Length Round Rigid Pipe	HTI 5	\$ 231	Y	14	28	14	Y

10" B-Vent Components - Elbow

		Disc. Code	MSRP USD	004 IA	010 PA	014 CA	016 NC	EXP
DV-10BVL45	45° Adjustable Elbow	HTI 5	\$ 290	Y	Y	Y	14	Y

10" B-vent Draft Hood Connector

		Disc. Code	MSRP USD	004 IA	010 PA	014 CA	016 NC	EXP
DV-10BVC	10" B-vent Draft Hood Connector	HTI 5	\$ 132	35	35	28	35	Y

10" B-vent High Wind Cap

		Disc. Code	MSRP USD	004 IA	010 PA	014 CA	016 NC	EXP
DV-10BVVT	10" B-vent High Wind Cap	HTI 5	\$ 339	Y	14	28	14	Y

10" B-Vent Components - Firestop/Straps/Support

		Disc. Code	MSRP USD	004 IA	010 PA	014 CA	016 NC	EXP
DV-7DP-WS	Wall Strap (DuraPlus Mult applies)	HTI 5	\$ 91	Y	14	28	14	Y
DV-10GVFS	Firestop Spacer	HTI 5	\$ 107	Y	14	Y	14	Y

10" B-Vent Components - Shield/Flashing/Collars

		Disc. Code	MSRP USD	004 IA	010 PA	014 CA	016 NC	EXP
DV-10BVSC	Storm Collar	HTI 5	\$ 32	Y	14	28	14	Y
DV-10BVF	Adjustable Roof Flashing	HTI 5	\$ 121	Y	14	28	14	Y
DV-10BVFF	Tall Cone Flat Flashing	HTI 5	\$ 169	Y	14	28	14	Y

10" B-Vent Components - Straight Section

		Disc. Code	MSRP USD	004 IA	010 PA	014 CA	016 NC	EXP
DV-10BV18	18* LENGTH OF 10* B-VENT	HTI 5	\$ 212	Y	Y	Y	14	Y
DV-10BV36	36* LENGTH OF 10* B-VENT	HTI 5	\$ 299	Y	Y	Y	14	Y
DV-10BV18A	18* ADJ LENTH OF 10*BV	HTI 5	\$ 319	Y	14	Y	14	Y

DVP Components-MultiPk - Firestop/Straps/Support

		Disc. Code	MSRP USD	004 IA	010 PA	014 CA	016 NC	EXP
DVP-FSM	Ceiling firestop (multi-pack of 10)	HTI 1	\$ 545	Y	Y	Y	Y	Y

DVP Components-MultiPk - Shield/Flashing/Collars

		Disc. Code	MSRP USD	004 IA	010 PA	014 CA	016 NC	EXP
DVP-WSM	DVP Wall Shield (6 piece)	HTI 1	\$ 545	Y	21	14	14	Y

DVP Components-SinglePk - Elbow

		Disc. Code	MSRP USD	004 IA	010 PA	014 CA	016 NC	EXP
DVP45	45 Degree elbow	HTI 1	\$ 137	Y	Y	Y	Y	Y
DVP90ST	90 Degree elbow	HTI 1	\$ 142	Y	Y	Y	Y	Y

DVP Components-SinglePk - Firestop/Straps/Support

		Disc. Code	MSRP USD	004 IA	010 PA	014 CA	016 NC	EXP
DVP-HVS	Horizontal pipe support	HTI 1	\$ 47	Y	Y	14	14	Y
DVP-FS	Ceiling firestop	HTI 1	\$ 66	Y	Y	Y	Y	Y
DVP-WS	Wall Firestop	HTI 1	\$ 91	Y	Y	Y	Y	Y

DVP Components-SinglePk - Shield/Flashing/Collars

		Disc. Code	MSRP USD	004 IA	010 PA	014 CA	016 NC	EXP
UNIV-AS2	Attic insulation shield (firestop not included)	HTI 1	\$ 51	Y	Y	Y	Y	Y
DVP-RDS	Roof Deck Underside Insulation Shield	HTI 1	\$ 257	8	21	Y	14	Y

DVP Components-SinglePk - Straight Section

		Disc. Code	MSRP USD	004 IA	010 PA	014 CA	016 NC	EXP
DVP4	4" (102mm) length of double wall	HTI 1	\$ 73	Y	Y	Y	Y	Y
DVP6	6" (152mm) length of double wall	HTI 1	\$ 81	Y	Y	Y	Y	Y
DVP6A	3 - 6" (76-152mm) slip section to slide over pipe (can be cut to length)	HTI 1	\$ 87	Y	Y	Y	Y	Y
DVP12	12" (305mm) length of double wall	HTI 1	\$ 113	Y	Y	Y	Y	Y
DVP12A	3 - 12" (76-305mm) slip section to slide over pipe (can be cut to length)	HTI 1	\$ 118	Y	Y	Y	Y	Y
DVP24	24" (610mm) length of double wall	HTI 1	\$ 120	Y	Y	Y	Y	Y
DVP36	36" (914mm) length of double wall	HTI 1	\$ 129	Y	Y	Y	Y	Y
DVP48	48" (1219mm) length of double wall	HTI 1	\$ 183	Y	Y	Y	Y	Y

DVP Termination Kits - Multi Pk - Brick Extension

		Disc. Code	MSRP USD	004 IA	010 PA	014 CA	016 NC	EXP
BEK	Brick extension kit, 14" x 14" (multi-pack of 10)	HTI 1	\$ 741	8	21	14	14	N
DVP-BEK2	Brick extension kit, 12" x 14" (multi-pack of 10)(box quantities only)	HTI 1	\$ 803	Y	Y	14	Y	Y

DVP Termination Kits - Multi Pk - Shield/Flashing/Collars

		Disc. Code	MSRP USD	004 IA	010 PA	014 CA	016 NC	EXP
DVP-TRAPFL	Trap cap rain flashing (multi-pack of 4)	HTI 1	\$ 119	Y	Y	Y	Y	Y
DVP-HSM-B	26" (660mm) trimmable heat shield (multi-pack of 6)	HTI 1	\$ 195	Y	21	14	14	Y

DVP Termination Kits - Single Pk - Shield/Flashing/Collars

		Disc. Code	MSRP USD	004 IA	010 PA	014 CA	016 NC	EXP
TRAP-VSS	Vinyl siding shield	HTI 1	\$ 24	Y	Y	Y	Y	Y
VPK-DV	Vinyl protector kit	HTI 1	\$ 105	14	Y	14	14	Y

DVP Termination Kits - Single Pk - Termination

		Disc. Code	MSRP USD	004 IA	010 PA	014 CA	016 NC	EXP
DVP-TV	Vertical direct vent termination cap, with storm collar	HTI 1	\$ 295	Y	Y	Y	Y	Y
DVP-TVHW	Vertical termination cap - high wind (includes 18901 storm collar)	HTI 1	\$ 308	Y	Y	Y	Y	Y
DVP-TRAP2	Horizontal termination cap with long flue, attached slip and wall shield with heat shield, 5-3/8" - 9-3/8" (137 -238mm)	HTI 1	\$ 308	Y	Y	Y	Y	Y
DVP-TRAP1	Horizontal termination cap with short flue, attached slip and wall shield with heat shield, 3-1/8" - 4-5/8" (79-117mm)	HTI 1	\$ 308	Y	Y	Y	Y	Y
DVP-HPC2	Horizontal high performance termination cap (long flue with attached slip, and wall shield with heat shield)	HTI 1	\$ 364	Y	Y	Y	14	Y
DVP-HPC1	High performance termination cap (short flue with attached slip, and wall shield with heat shield)	HTI 1	\$ 364	Y	21	14	14	Y
DVP-TRAPK2	Horizontal termination kit (includes DVP-TRAP2, slip section, wall shield and DVP90ST)	HTI 1	\$ 418	Y	Y	Y	Y	Y
DVP-TRAPK1	Horizontal termination kit (includes DVP-TRAP1, slip section, wall shield and DVP90ST)	HTI 1	\$ 418	Y	Y	Y	14	Y
DVP-HRC-ZC-SS	Horizontal high rise termination cap, glass termination base, DVP pipe (stainless steel)	HTI 1	\$ 486	8	21	14	14	Y
DVP-HRC-SS	Horizontal high rise termination cap, standard base, DVP pipe (stainless steel)	HTI 1	\$ 486	8	21	14	14	Y
DVP-TB1	Horizontal snorkel cap for basement applications	HTI 1	\$ 497	Y	21	14	14	Y

Roof Flashing

		Disc. Code	MSRP USD	004 IA	010 PA	014 CA	016 NC	EXP
RF6	Roof flashing, 0/12 - 6/12 roof pitch	HTI 1	\$ 163	Y	Y	Y	Y	Y
RF12	Roof flashing, 7/12 - 12/12 roof pitch	HTI 1	\$ 200	Y	Y	Y	Y	Y

SLP Flex Pipe - Components

		Disc. Code	MSRP USD	004 IA	010 PA	014 CA	016 NC	EXP
SLP-FLEX-3	3' (914mm) SL pipe length - flexible venting	HTI 1	\$ 162	Y	21	21	14	N
SLP-FLEX-5	5' (1524mm) SL pipe length - flexible venting	HTI 1	\$ 215	Y	Y	Y	21	N
SLP-FLEX-10	10' (3048mm) SL pipe length - flexible venting	HTI 1	\$ 308	Y	Y	Y	14	Y

SLP Flex Pipe - Termination Kits

		Disc. Code	MSRP USD	004 IA	010 PA	014 CA	016 NC	EXP
SLP-FLEX-TRAP	Trapezoid termination kit (includes cap and wall thimble)	HTI 1	\$ 391	Y	14	Y	21	N
SLP-FLEXTRAP30B	Trapezoid termination kit (includes 24" of flex, trap cap with 6" collar and firestop)	HTI 1	\$ 486	Y	21	Y	14	Y

Decorative Shroud B-Vent - Termination

		Disc. Code	MSRP USD	004 IA	010 PA	014 CA	016 NC	EXP
LDS-BV	Decorative shroud for 5" or 6" B-vent	HTI 1	\$ 335	Y	21	14	Y	Y

Decorative Shrouds for Direct Vent - Shroud

		Disc. Code	MSRP USD	004 IA	010 PA	014 CA	016 NC	EXP
DRC-RADIUS	Decorative radius cover for SLP/DVP-TRAP	HTI 1	\$ 295	Y	Y	Y	Y	Y

Shrouds for Gas Units - Shroud

		Disc. Code	MSRP USD	004 IA	010 PA	014 CA	016 NC	EXP
TCG375	Vertical terra cotta termination cap cover (for DV and BV units)	HTI 1	\$ 497	Y	Y	14	14	N
COOL-ADDM	Safety shields for horizontal termination caps (multi-pack of 6)	HTI 1	\$ 566	Y	Y	14	Y	Y

SLP - Black - Collar

		Disc. Code	MSRP USD	004 IA	010 PA	014 CA	016 NC	EXP
STOVEDV-BK	Stove collar for DuraVent pipe - Black	HTI 3	\$ 68	Y	14	Y	14	Y
STOVEICC-BK	Stove collar for ICC pipe - Black	HTI 3	\$ 74	21	Y	28	21	Y

SLP - Black - Decorative

		Disc. Code	MSRP USD	004 IA	010 PA	014 CA	016 NC	EXP
SLP-WT-BK	Decorative wall thimble cover - Black	HTI 3	\$ 99	Y	Y	Y	14	Y
SLP-DCF-BK	Decorative ceiling firestop - Black	HTI 3	\$ 103	Y	Y	Y	14	Y
SLP-CCS-BK	Cathedral ceiling support - Black	HTI 3	\$ 152	Y	Y	Y	14	Y

SLP - Black - Elbow

		Disc. Code	MSRP USD	004 IA	010 PA	014 CA	016 NC	EXP
SLP90-BK	90 Degree elbow - Black	HTI 3	\$ 118	Y	Y	Y	14	Y
SLP45-BK	45 Degree elbow - Black	HTI 3	\$ 118	Y	Y	Y	14	Y

SLP - Black - Single-Pack - Adapter

		Disc. Code	MSRP USD	004 IA	010 PA	014 CA	016 NC	EXP
SLP-SA	Stove adapter	HTI 1	\$ 17	Y	21	14	14	Y

SLP - Black - Straight Section

		Disc. Code	MSRP USD	004 IA	010 PA	014 CA	016 NC	EXP
SLP6A-BK	2" - 6" (51 - 152mm) slip section to slide over pipe (can be cut to length) - Black	HTI 3	\$ 68	Y	Y	Y	14	Y
SLP4-BK	4" (102mm) pipe length - Black	HTI 3	\$ 69	Y	Y	14	14	Y
SLP12A-BK	2" - 12" (51 - 305mm) slip section to slide over pipe (can be cut to length) - Black	HTI 3	\$ 72	Y	Y	Y	14	Y
SLP6-BK	6" (152mm) pipe length - Black	HTI 3	\$ 75	Y	Y	Y	14	Y
SLP12-BK	12" (305mm) pipe length - Black	HTI 3	\$ 84	Y	Y	Y	21	Y
SLP24-BK	24" (610mm) pipe length - Black	HTI 3	\$ 110	Y	Y	Y	14	Y
SLP36-BK	36" (914mm) pipe length - Black	HTI 3	\$ 128	Y	Y	Y	14	Y
SLP48-BK	48" (1219mm) pipe length - Black	HTI 3	\$ 169	Y	Y	Y	14	Y

SLP - Black - Termination

		Disc. Code	MSRP USD	004 IA	010 PA	014 CA	016 NC	EXP
LINK-STOVE	Stove adapter kit (includes 30' of 4" flex, adapters, wall thimble, masonry, and ZC flashing, 991DA cap and fasteners)	HTI 1	\$ 504	Y	Y	Y	14	N
SLP-SK-BK	Horizontal trapezoid termination kit (includes 1 each CCSLP, SLP-HHW2, SLP-WT-BK, SLP24-BK, SLP6-BK, SLP6A-BK, SLP90-BK)	HTI 1	\$ 759	Y	Y	14	14	Y

SLP - Components - Single-Pack - Elbow

		Disc. Code	MSRP USD	004 IA	010 PA	014 CA	016 NC	EXP
SLP45	45 Degree elbow	HTI 1	\$ 122	Y	Y	Y	Y	Y
SLP90	90 Degree elbow	HTI 1	\$ 124	Y	Y	Y	Y	Y

SLP - Components - Single-Pack - Firestop/Straps/Support

		Disc. Code	MSRP USD	004 IA	010 PA	014 CA	016 NC	EXP
SLP-FS	Ceiling firestop	HTI 1	\$ 50	Y	Y	Y	Y	Y
SLP-WS	Wall firestop	HTI 1	\$ 58	Y	Y	Y	Y	Y
SLP-HVS	Horizontal vent support hanger	HTI 1	\$ 62	Y	Y	14	14	Y

SLP - Components - Single-Pack - Shield/Flashing/Collars

		Disc. Code	MSRP USD	004 IA	010 PA	014 CA	016 NC	EXP
SLP-RF6	0/12 - 6/12 roof flashing	HTI 1	\$ 82	Y	Y	Y	Y	Y
SLP-RF12	7/12-12/12 roof flashing	HTI 1	\$ 124	Y	Y	Y	Y	Y
SLP-RDS	Roof Deck Underside Insulation Shield	HTI 1	\$ 257	8	21	Y	14	Y

SLP - Components - Single-Pack - Straight Section

		Disc. Code	MSRP USD	004 IA	010 PA	014 CA	016 NC	EXP
SLP6A	2" - 6" (51 - 152mm) slip section to slide over pipe (can be cut to length)	HTI 1	\$ 62	Y	Y	Y	Y	Y
SLP4	4" (102mm) pipe length	HTI 1	\$ 65	Y	Y	Y	Y	Y
SLP6	6" (152mm) pipe length	HTI 1	\$ 65	Y	Y	Y	Y	Y
SLP12A	2" - 12" (51 - 305mm) slip section to slide over pipe (can be cut to length)	HTI 1	\$ 77	Y	Y	Y	Y	Y
SLP12	12" (305mm) pipe length	HTI 1	\$ 91	Y	Y	Y	Y	Y
DVP-2SL	DVP to SLP adapter converts 8 inch to 6-5/8	HTI 1	\$ 99	Y	Y	Y	Y	N
SLP24	24" (610mm) pipe length	HTI 1	\$ 106	Y	Y	Y	Y	Y
DVP-SLP24	DVP to SLP 24" (640mm) pipe length adapter	HTI 1	\$ 117	Y	Y	Y	Y	Y
SLP36	36" (914mm) pipe length	HTI 1	\$ 117	Y	Y	Y	Y	Y
SL-2DVP	SLP to DVP adapter	HTI 1	\$ 145	Y	Y	Y	14	N
SLP48	48" (1219mm) pipe length	HTI 1	\$ 154	Y	Y	Y	Y	Y

SLP - Term Kits & Acc - Single Pack - Termination

		Disc. Code	MSRP USD	004 IA	010 PA	014 CA	016 NC	EXP
SLP-TVHW	Vertical termination cap - high wind (includes 4071-004 storm collar)	HTI 1	\$ 195	Y	Y	Y	Y	Y
SLP-TRAP2	Horizontal trapezoid termination Kit 5-1/4 - 9-1/4" (133-235mm) wall thickness	HTI 1	\$ 308	Y	Y	Y	Y	Y
SLP-TRAP1	Horizontal trapezoid termination short flue 3-1/8 -4-3/4" (79-121mm), includes SLP-WS	HTI 1	\$ 308	Y	Y	Y	14	Y
SLP-HHW2	Horizontal high wind trapezoid termination (includes 1 - SLP-WS)	HTI 1	\$ 381	Y	21	Y	14	Y
SLP-TRAPK2	Top vent horizontal term kit #2 (includes SLP-TRAP2, slip section, wall shield, SLP90)	HTI 1	\$ 418	Y	Y	Y	Y	Y
SLP-TRAPK1	Top vent horizontal term kit #1 (includes SLP-TRAP1, slip section, wall shield, SLP90)	HTI 1	\$ 418	Y	21	Y	14	Y
SLP-HRC-SS	Horizontal high-rise termination - stainless steel (includes 1 - SLP-WS)	HTI 1	\$ 442	Y	21	14	14	Y
SLP-TB1	Horizontal snorkel cap for basement applications	HTI 1	\$ 497	Y	21	14	14	Y
SLK-SNKD	SL snorkel cap, adds 14" vertical rise (includes firestop)	HTI 1	\$ 599	Y	Y	Y	14	N

Gas Insert Venting - 30/30 Termination Kits

		Disc. Code	MSRP USD	004 IA	010 PA	014 CA	016 NC	EXP
LINK-DV4-30B	Direct vent insert kit - one 4 - liner, one 30 - liner, plus term cap components	HTI 1	\$ 549	Y	Y	Y	Y	Y
LINK-DV30B	Direct vent insert kit - two 30 - liners, plus term cap components	HTI 1	\$ 649	Y	Y	Y	Y	Y
LINKSQB-DV4-30	Direct vent insert kit - one 4 - liner, one 30 - liner, plus black term cap components	HTI 1	\$ 649	Y	Y	14	14	Y
LINKSQB-DV30	Direct vent insert kit - two 30 - liners, plus black term cap components	HTI 1	\$ 729	Y	Y	Y	14	Y
LINKSQC-DV30	Direct vent insert kit - two 30" liners, plus faux copper term cap components	HTI 1	\$ 789	Y	Y	Y	14	Y

Gas Insert Venting - Components

		Disc. Code	MSRP USD	004 IA	010 PA	014 CA	016 NC	EXP
FLEX-CNCT	Connector kit -- 3" liner to 3" liner (1 connector per kit)	HTI 1	\$ 70	Y	Y	14	14	Y
95070310	BD Flex liner 3x10 aluminum	HTI 4	\$ 71	Y	21	14	14	N
LINK-ZC-ADPB	14 1/2" round flashing adapter kit (for use with existing liner kits when using Class A pipe)	HTI 1	\$ 90	Y	Y	14	14	Y
FLEX3-30	One 3" flexible liner (expands to 30')	HTI 1	\$ 143	Y	Y	21	21	N
95070325	BD Flex liner 3x25 aluminum	HTI 4	\$ 164	Y	14			N
DV-46DVA-GCL	Colinear adapter for stoves with SLP coaxial outlets	HTI 5	\$ 305	Y	Y	Y	14	N
DV-46DVA-GK	Adapter kit - colinear 3" to direct vent pipe to extend the run	HTI 5	\$ 329	Y	14	28	14	N

Insulated Flex Duct - Chimney Air Kits/Flex Duct

		Disc. Code	MSRP USD	004 IA	010 PA	014 CA	016 NC	EXP
ID4	4" (100mm) insulated flex duct for outside air - includes two 42" (1065mm) sections	HTI 1	\$ 82	Y	Y	14	Y	Y
ID6	6" (152mm) insulated flex duct for use with outside air kit - includes two 42" (1065mm) sections	HTI 1	\$ 95	Y	Y	Y	Y	Y

Outside Air Kit

		Disc. Code	MSRP USD	004 IA	010 PA	014 CA	016 NC	EXP
OA-RD-6	Outside air elbow kit (used to offset outside air starting collar)	HTI 1	\$ 59	Y	21	14	14	Y
OAK-ACC	ACC outside air kit	HTI 4	\$ 61	Y	Y	Y	21	Y
AK22	Outside air kit - (flex not included)	HTI 1	\$ 68	Y	Y	Y	Y	Y
AKD	Outside Combustion Air Kit with Access Door	MON 1	\$ 72	Y	21	14	Y	Y
OAK-3	Outside air kit	HTI 4	\$ 126	Y	Y	Y	21	Y
AK-TV	Outside air kit - (25" un-insulated flex duct included)	HTI 1	\$ 179	14	21	14	14	Y

Uninsulated Flex Duct - Chimney Air Kits/Flex Duct

		Disc. Code	MSRP USD	004 IA	010 PA	014 CA	016 NC	EXP
UD4	4" (100mm) uninsulated flex duct for outside air - includes two 42" (1065mm) sections	HTI 1	\$ 53	Y	Y	Y	Y	Y
UD6	6" (152mm) uninsulated flex duct for use with outside air kit - includes two 42" (1065mm) sections	HTI 1	\$ 67	Y	21	14	14	Y

SLP and DVP - Shield/Flashing/Collars

		Disc. Code	MSRP USD	004 IA	010 PA	014 CA	016 NC	EXP
UNIV-AS2M	Attic shield (multi-pack of 6) (firestop not included)	HTI 1	\$ 215	Y	Y	Y	Y	Y

3" Pellet Vent Pro - Adapter/Incraser/Tee

		Disc. Code	MSRP USD	004 IA	010 PA	014 CA	016 NC	EXP
DV-3PVP-AD	3" PV Appliance Adapter	HTI 5	\$ 39	Y	Y	Y	14	N
DV-3PVP-ADFF	3" PV Female Flex Adapter	HTI 5	\$ 49	35	35	28	35	N
DV-3PVP-ADHB	3" PV pipe adapter	HTI 5	\$ 58	Y	Y	Y	14	N
DV-3PVP-ADB	3" PV Appliance Adapter Black	HTI 5	\$ 58	35	14	28	35	N
DV-3PVP-ADFM	3" PV Male Flex Adapter	HTI 5	\$ 67	35	35	28	35	N
DV-3PVP-CO1	3* CLEAN OUT TEE CAP	HTI 5	\$ 79	35	35	28	35	Y
DV-3PVP-HC2	HORIZONTAL CAP	HTI 5	\$ 88	Y	Y	Y	14	Y
DV-3PVP-INC	2IN-3IN INCREASER	HTI 5	\$ 88	35	35	28	35	Y
DV-3PVP-COB1	End cap for 3" pellet T	HTI 5	\$ 91	35	35	28	35	Y
DV-3PVP-12A	12" Pipe Extension	HTI 5	\$ 96	Y	Y	Y	14	N
DV-3PVP-X4	Incraser 3" - 4"	HTI 5	\$ 121	35	35	28	35	N
DV-3PVP-X4AD	Appliance Adapter/Incraser 3" - 4"	HTI 5	\$ 140	35	35	28	35	N
DV-3PVP-X6	Chimney Adapter - 6"	HTI 5	\$ 169	35	35	28	35	N
DV-3PVP-X4ADB	Appliance Adapter/Incraser 3" - 4" (black)	HTI 5	\$ 182	35	35	28	35	N
DV-3PVP-X4ADHB	Appliance Adapter/Incraser 3" - 4"	HTI 5	\$ 183	Y	35	28	35	N
DV-3PVP-T1	SNG TEE/CLEAN OUT CAP	HTI 5	\$ 209	Y	Y	Y	14	Y
DV-3PVP-TAD1	ADPTR TEE W/ CO CAP	HTI 5	\$ 209	35	35	28	35	Y
DV-3PVP-X8	Chimney Adapter - 8"	HTI 5	\$ 210	35	35	28	35	N
DV-3PVP-TADX41	3-4 INCRS ADPT TEE	HTI 5	\$ 222	35	35	28	35	Y
DV-3PVP-TB1	BLK SNG TEE W/ CLEAN OUT	HTI 5	\$ 226	Y	14	28	14	Y
DV-3PVP-TADB	3" PV Adapter Tee w/Clean-Out Tee Cap (black)	HTI 5	\$ 226	35	35	28	35	N
DV-3PVP-TADX4B1	3-4 INCRS ADPT TEE BLACK	HTI 5	\$ 240	35	35	28	35	Y
DV-3PVP-DBT1	DBL TEE W/ CLEAN OUT CAP	HTI 5	\$ 405	35	35	28	35	Y
DV-3PVP-DBTB1	BLK DBL TEE W/ CLEAN OUT	HTI 5	\$ 405	35	35	28	35	Y

3" Pellet Vent Pro - Anchor

		Disc. Code	MSRP USD	004 IA	010 PA	014 CA	016 NC	EXP
DV-3PVP-WS	3" PV Wall Strap	HTI 5	\$ 48	35	35	Y	35	N
DV-3PVP-WSA	3" PV Adjustable Wall Strap	HTI 5	\$ 53	Y	14	Y	14	N

3" Pellet Vent Pro - Elbow

		Disc. Code	MSRP USD	004 IA	010 PA	014 CA	016 NC	EXP
DV-3PVP-E45	3" PV 45 Degree Elbow	HTI 5	\$ 125	Y	Y	Y	14	N
DV-3PVP-E45B	3" PV 45 Degree Elbow (black)	HTI 5	\$ 139	Y	Y	28	14	N
DV-3PVP-E90	3" PV 90 Degree Elbow	HTI 5	\$ 156	Y	Y	Y	14	Y
DV-3PVP-E90B	3" PV 90 Degree Elbow (black)	HTI 5	\$ 176	Y	Y	28	14	N

3" Pellet Vent Pro - Kit

		Disc. Code	MSRP USD	004 IA	010 PA	014 CA	016 NC	EXP
DV-3PVP-AIK	3" - 4" PelletVent Pro Fresh Air Intake Kit (includes: faceplate w/screen, moisture barrier, aluminum flex, [2] clamp) Made for 3-inch exhaust outlets with 2-inch air inlets. Not for use with Harman products.	HTI 5	\$ 106	35	35	28	35	N
DV-3PVP-WTI	3" Wall Thimble Air Intake Kit (includes: Wall Thimble [for 1" clearance]; 2" AL Flex; [2] hose clamps)	HTI 5	\$ 309	Y	Y	28	35	N
DV-3PVP-KHA	3" PelletVent Pro Horizontal Kit (includes: Round Horizontal Cap, Wall Thimble [for 1" clearance], Appliance Adapter [black])	HTI 5	\$ 354	35	35	28	35	N
DV-3PVP-KVAC	3" Vertical kit - flat - CA	HTI 5	\$ 402	35	35	28	35	N
DV-3PVP-KVA	3" PelletVent Pro Vertical Kit - Flat Ceiling (includes: Vertical Cap, Storm Collar, Ceiling Support Firestop Spacer [for 1" clearance], Adjustable Flashing, Appliance Adapter [black])	HTI 5	\$ 493	35	35	28	35	N

3" Pellet Vent Pro - Shield/Flashing/Collars

		Disc. Code	MSRP USD	004 IA	010 PA	014 CA	016 NC	EXP
DV-3PVP-SC	3" PV Storm Collar	HTI 5	\$ 13	Y	14	Y	14	N
DV-3PVP-WSA-EXT	3" PV Wall Strap Extension	HTI 5	\$ 26	35	35	28	35	N
DV-3PVP-F6	3" PV Adjustable Roof Flashing 0/12-6/12	HTI 5	\$ 41	35	35	Y	35	N
DV-3PVP-RC	3" PV Reduction Collar	HTI 5	\$ 43	35	35	28	35	N
DV-3PVP-FF	3" PV Tall Cone Roof Flashing	HTI 5	\$ 54	35	35	28	35	N
DV-3PVP-F6DS	3" PV DSA Roof Flashing 0/12 - 6/12	HTI 5	\$ 107	35	35	28	35	N
DV-3PVP-IS	3" PV Attic Insulation Shield	HTI 5	\$ 108	35	35	28	35	N
DV-3PVP-F12DS	3" PV DSA Roof Flashing 7/12 - 12/12	HTI 5	\$ 116	35	35	28	35	N
DV-3PVP-FTC	3" PV Flex Trim Collar	HTI 5	\$ 133	35	35	28	35	N
DV-3PVP-WT	Wall Thimble (for 1" clearance)	HTI 5	\$ 133	Y	Y	Y	14	N

3" Pellet Vent Pro - Straight Section

		Disc. Code	MSRP USD	004 IA	010 PA	014 CA	016 NC	EXP
DV-3PVP-06	6" Straight Length Pipe	HTI 5	\$ 50	Y	Y	Y	14	N
DV-3PVP-06B	6" Straight Length Pipe (black)	HTI 5	\$ 70	Y	Y	28	14	N
DV-3PVP-12	12" Straight Length Pipe	HTI 5	\$ 71	Y	Y	Y	14	Y
DV-3PVP-24	24" Straight Length Pipe	HTI 5	\$ 93	Y	Y	Y	14	N
DV-3PVP-12B	12" Straight Length Pipe (black)	HTI 5	\$ 93	Y	Y	28	14	N
DV-3PVP-12AB	12" Pipe Extension (black)	HTI 5	\$ 115	Y	Y	28	14	N
DV-3PVP-24B	24" Straight Length Pipe (black)	HTI 5	\$ 116	Y	Y	28	14	N
DV-3PVP-36	36" Straight Length Pipe	HTI 5	\$ 128	Y	Y	Y	14	N
DV-3PVP-36B	36" Straight Length Pipe (black)	HTI 5	\$ 145	Y	Y	28	14	N
DV-3PVP-18A	18" Pipe Extension	HTI 5	\$ 147	35	35	Y	35	N
DV-3PVP-18AB	18" Pipe Extension (black)	HTI 5	\$ 176	Y	14	28	14	N
DV-3PVP-60	60" Straight Length Pipe	HTI 5	\$ 183	Y	14	Y	14	N
DV-3PVP-60B	60" Straight Length Pipe (black)	HTI 5	\$ 216	Y	14	28	14	N
DV-3PVP-60F	60" Flex Pipe	HTI 5	\$ 313	35	35	28	35	N

3" Pellet Vent Pro - Straps/Support

		Disc. Code	MSRP USD	004 IA	010 PA	014 CA	016 NC	EXP
DV-3PVP-FS	3" PV Ceiling Support Firestop Spacer (for 1" clearance)	HTI 5	\$ 102	35	35	28	35	N
DV-3PVP-WTC	Ceiling Support/Wall Thimble Cover	HTI 5	\$ 110	35	35	28	35	N
DV-3PVP-CS	3" PV Cathedral Ceiling Support Box	HTI 5	\$ 211	35	35	28	35	N

3" Pellet Vent Pro - Termination

		Disc. Code	MSRP USD	004 IA	010 PA	014 CA	016 NC	EXP
DV-3PVP-HSC	3" PV Square Horizontal Cap	HTI 5	\$ 102	Y	14	28	14	N
DV-3PVP-VC	3" PV Vertical Cap	HTI 5	\$ 116	Y	Y	Y	14	N

4" Pellet Vent Pro - Anchor

		Disc. Code	MSRP USD	004 IA	010 PA	014 CA	016 NC	EXP
DV-4PVP-WS	4" PV Wall Strap	HTI 5	\$ 52	35	35	28	35	N
DV-4PVP-WSA	4" PV Adjustable Wall Strap	HTI 5	\$ 57	35	35	28	35	N

4" Pellet Vent Pro - Elbow

		Disc. Code	MSRP USD	004 IA	010 PA	014 CA	016 NC	EXP
DV-4PVP-E45	4" PV 45 Degree Elbow	HTI 5	\$ 141	Y	14	28	14	N
DV-4PVP-E45B	4" PV 45 Degree Elbow (black)	HTI 5	\$ 176	35	35	28	35	N
DV-4PVP-E90	4" PV 90 Degree Elbow	HTI 5	\$ 195	Y	14	28	14	N
DV-4PVP-E90B	4" PV 90 Degree Elbow (black)	HTI 5	\$ 228	35	35	28	35	N

4" Pellet Vent Pro - Kit

		Disc. Code	MSRP USD	004 IA	010 PA	014 CA	016 NC	EXP
DV-3PVP-KHAC	3" PV Horizontal kit - CA	HTI 5	\$ 303	35	35	28	35	N
DV-4PVP-WTI	4" Wall Thimble Air Intake Kit (includes: Wall Thimble [for 1" clearance]; 2" AL Flex; [2] hose clamps)	HTI 5	\$ 333	35	35	28	35	N
DV-4PVP-KVAC	4" PV Vertical kit	HTI 5	\$ 432	35	35	28	35	N
DV-4PVP-KHA	4" PelletVent Pro Horizontal Kit (includes: Round Horizontal Cap, Wall Thimble [for 1" clearance], Appliance Adapter/Increaser 3" - 4" [black])	HTI 5	\$ 463	35	35	28	35	N
DV-4PVP-KVA	4" PelletVent Pro Vertical Kit - Flat Ceiling (includes: Vertical Cap, Storm Collar, Ceiling Support Firestop Spacer [for 1" clearance], Adjustable Flashing, Appliance Adapter/increaser 3" - 4" [black])	HTI 5	\$ 530	35	35	28	35	N

4" Pellet Vent Pro - Shield/Flashing/Collars

		Disc. Code	MSRP USD	004 IA	010 PA	014 CA	016 NC	EXP
DV-4PVP-SC	4" PV Storm Collar	HTI 5	\$ 14	35	35	28	35	N
DV-4PVP-RC	4" PV Reduction Collar	HTI 5	\$ 43	35	35	28	35	N
DV-4PVP-F6	4" PV Adjustable Roof Flashing	HTI 5	\$ 45	35	35	28	35	N
DV-4PVP-IS	4" PV Attic Insulation Shield	HTI 5	\$ 108	35	35	28	35	N
DV-4PVP-FTC	4" PV Flex Trim Collar	HTI 5	\$ 127	35	35	28	35	N
DV-4PVP-WT	4" PV Wall Thimble (for 1" clearance)	HTI 5	\$ 143	Y	Y	28	14	N

4" Pellet Vent Pro - Straight Section

		Disc. Code	MSRP USD	004 IA	010 PA	014 CA	016 NC	EXP
DV-4PVP-06	6" Straight Length Pipe	HTI 5	\$ 53	Y	14	28	14	N
DV-4PVP-12	12" Straight Length Pipe	HTI 5	\$ 76	Y	14	28	14	N
DV-4PVP-06B	6" Straight Length Pipe (black)	HTI 5	\$ 86	35	35	28	35	N
DV-4PVP-12A	12" Pipe Extension	HTI 5	\$ 107	35	35	28	35	N
DV-4PVP-24	24" Straight Length Pipe	HTI 5	\$ 118	Y	14	28	14	N
DV-4PVP-12B	12" Straight Length Pipe (black)	HTI 5	\$ 119	35	35	28	35	N
DV-4PVP-12AB	12" Pipe Extension (black)	HTI 5	\$ 150	35	35	28	35	N
DV-4PVP-36	4" PV 36" Straight Length Pipe	HTI 5	\$ 153	Y	14	28	14	N
DV-4PVP-24B	24" Straight Length Pipe (black)	HTI 5	\$ 160	35	35	28	35	N
DV-4PVP-18A	18" Pipe Extension	HTI 5	\$ 163	35	35	28	35	N
DV-4PVP-36B	36" Straight Length Pipe (black)	HTI 5	\$ 188	35	35	28	35	N
DV-4PVP-60	60" Straight Length Pipe	HTI 5	\$ 206	Y	14	Y	14	Y
DV-4PVP-18AB	18" Pipe Extension (black)	HTI 5	\$ 230	35	35	28	35	N
DV-4PVP-60B	60" Straight Length Pipe (black)	HTI 5	\$ 249	35	35	28	35	N
DV-4PVP-60F	60" Flex Pipe	HTI 5	\$ 446	35	35	28	35	N

4" Pellet Vent Pro - Straps/Support

		Disc. Code	MSRP USD	004 IA	010 PA	014 CA	016 NC	EXP
DV-4PVP-FS3	4" PV Ceiling Support Firestop Spacer (for 3" clearance) - Canada*	HTI 5	\$ 97	35	35	28	35	N
DV-4PVP-FS	4" PV Ceiling Support Firestop Spacer (for 1" clearance)	HTI 5	\$ 119	35	35	28	35	N
DV-4PVP-CS	4" PV Cathedral Ceiling Support Box	HTI 5	\$ 211	35	35	28	35	N

4" Pellet Vent Pro - Termination

		Disc. Code	MSRP USD	004 IA	010 PA	014 CA	016 NC	EXP
DV-4PVP-HSC	4" PV Square Horizontal Cap	HTI 5	\$ 113	35	35	28	35	N
DV-4PVP-VC	4" PV Vertical Cap	HTI 5	\$ 124	35	35	28	35	N

Venting

		Disc. Code	MSRP USD	004 IA	010 PA	014 CA	016 NC	EXP
CCSLP	Radiance, Stardance, Oxford SLP adapter	HTI 1	\$ 30	Y	Y	Y	14	N
DV-46DVA-ADP	Duravent Appliance Adapter for Radiance, Stardance & Oxford	HTI 5	\$ 101	Y	Y	Y	14	Y
MBDVP	VCG Fireplace Unit 8" adapter to DVP (Carton of 8)	VCG 1	\$ 151	8	21	14	14	N
MBSLP	VCG Fireplace Unit adapter to SLP (Carton of 8)	VCG 1	\$ 151	8	21	14	14	Y
MPSLP	VCG Inline Pipe adapter 4x7 Twist Lock to SLP (Carton of 8)	VCG 1	\$ 151	8	21	14	14	Y
SLPMP	SLP Unit & Inline Pipe adapter To 4x7 Twist Lock (Carton of 8)	VCG 1	\$ 158	8	21	14	14	Y
DVP58P	DVP Unit & Inline Pipe adapter to 8" pipe (Carton of 8)	VCG 1	\$ 162	8	21	14	14	N
FSDHAGSLP	Freestanding Draft Hood Adapter	HTI 1	\$ 240	8	21	14	14	Y
SLP-DVFAM	SLP Flex Adapter Kit w/gear clamps (multi-pack of 4)	VCG 1	\$ 381	8	21	14	14	Y
DVP-DVFAM	DVP Flex Adapter Kit w/gear clamps (multi-pack of 4)	VCG 1	\$ 393	8	21	14	14	Y

Adaptor

		Disc. Code	MSRP USD	004 IA	010 PA	014 CA	016 NC	EXP
ADP-CK30	Adapter kit (required for use with CK-30)	HTI 3	\$ 210	Y	Y	Y	14	Y
DG3	Thermal damper	HTI 1	\$ 350	Y	21	14	14	Y

Flue Collars

		Disc. Code	MSRP USD	004 IA	010 PA	014 CA	016 NC	EXP
0000555	8" Oval Flue Collar - Classic Black	HTI 0	\$ 179	21	21	28	21	Y
0000561	8" Oval Flue Collar - Twilight	VMT 0	\$ 269	21	21	28	21	Y
0000557	8" Oval Flue Collar - Majolica Brown	HTI 0	\$ 329	21	21	28	21	Y
0000560	8" Oval Flue Collar - Bordeaux	VMT 0	\$ 349	21	21	28	21	Y

Vermont Castings - Wood Stove Adaptors

		Disc. Code	MSRP USD	004 IA	010 PA	014 CA	016 NC	EXP
0001855	Oval to 8"round adapter, 8"w x11"h - Classic Black	HTI 1	\$ 81	Y	Y	28	21	N
0001860	Oval to 6"round adapter, 6"w x11"h - Classic Black	HTI 2	\$ 81	Y	Y	28	14	Y
0001841	Oval to 8"round offset adapter, 8" x 7"	HTI 1	\$ 118	21	21	28	21	Y
0001836	Oval to 8"round offset adapter, 8" x 5.5"	HTI 1	\$ 118	21	Y	28	21	N
0001846	Oval to 8"round elbow, 8" x 13"	HTI 1	\$ 125	21	21	28	21	Y
DV-6DVL-ORAD	6" x 14.5" Duravent DVL Double Wall Oval-to-Round Adapter	HTI 5	\$ 230	35	35	Y	35	Y
DV-8DVL-ORAD	8" x 14.5" Duravent DVL Double Wall Oval-to-Round Adapter	HTI 5	\$ 230	35	35	28	35	Y

Direct vent wall pass thru

		Disc. Code	MSRP USD	004 IA	010 PA	014 CA	016 NC	EXP
1-00-677177	Direct vent wall pass thru for 3" or 4" chimney	HTI 1	\$ 319	Y	Y	Y	14	Y

Top vent option

		Disc. Code	MSRP USD	004 IA	010 PA	014 CA	016 NC	EXP
1-00-777835	Top Vent Option (Designed for use with Masonry or Class A chimneys only)	HAR 2	\$ 479	21	21	28	21	Y
1-00-999670	Top Vent Option (Designed for use with Masonry or Class A Chimneys only)	HAR 2	\$ 479	21	21	28	21	Y
1-00-677120	Top vent option (Designed for use with Masonry or Class A chimneys only)	HAR 2	\$ 489	21	21	28	21	Y

14" Dura Vent DuraChimney II - Elbow

		Disc. Code	MSRP USD	004 IA	010 PA	014 CA	016 NC	EXP
14DCA-ES	Elbow strap	HTI 1	\$ 176	Y	14	28	Y	N
14DCA-E30	30 Degree elbow - must order 2	HTI 1	\$ 349	Y	Y	Y	Y	Y
14DCA-E15	15 Degree elbow - must order 2	HTI 1	\$ 349	35	35	28	35	N

14" Dura Vent DuraChimney II - Shield/Flashing/Collars

		Disc. Code	MSRP USD	004 IA	010 PA	014 CA	016 NC	EXP
14DCA-SC	Storm collar	HTI 1	\$ 61	Y	Y	Y	Y	N
14DCA-RRS	Roof radiation shield	HTI 1	\$ 96	Y	14	28	Y	N
14DCA-CTC	Chase top collar	HTI 1	\$ 273	Y	14	28	Y	Y
14DCA-CTF	Chase top flashing (Pre-bent)	HTI 1	\$ 278	35	35	28	35	N
14DCA-IS	Attic insulation shield (consists of two parts – collar and base)	HTI 1	\$ 680	Y	14	Y	Y	N

14" Dura Vent DuraChimney II - Straight Section

		Disc. Code	MSRP USD	004 IA	010 PA	014 CA	016 NC	EXP
14DCA-12	12" chimney section	HTI 1	\$ 177	Y	Y	Y	Y	N
14DCA-18	18" chimney section	HTI 1	\$ 206	Y	Y	Y	Y	N
14DCA-36	36" chimney section	HTI 1	\$ 340	Y	Y	Y	Y	N
14DCA-48	48" chimney section	HTI 1	\$ 365	Y	Y	Y	Y	N

14" Dura Vent DuraChimney II - Straps/Support

		Disc. Code	MSRP USD	004 IA	010 PA	014 CA	016 NC	EXP
14DCA-ST	Stabilizer	HTI 1	\$ 85	35	35	28	35	N
14DCA-FS	Firestop spacer	HTI 1	\$ 97	Y	Y	Y	Y	N
14DCA-WS	Wall strap	HTI 1	\$ 185	35	35	28	35	N

14" Dura Vent DuraChimney II - Termination

		Disc. Code	MSRP USD	004 IA	010 PA	014 CA	016 NC	EXP
14DCA-VC1	Round termination cap	HTI 1	\$ 546	Y	Y	Y	Y	Y

SL1100 Wood Pipe - Multi Pack - Firestop/Straps/Support Dimensions: 11" Inner / 13" Outer

		Disc. Code	MSRP USD	004 IA	010 PA	014 CA	016 NC	EXP
JB577	Joint band (package of 3)	HTI 1	\$ 60	Y	Y	14	14	Y
CB576	SL1100 and SL400 Series Chimney bracket (package of 3)	HTI 1	\$ 73	Y	Y	14	14	Y
SL11FL96	FLASHING SL1100 SERIES4X8	HTI 1	\$ 335	Y	Y	14	Y	N
FS538M	Firestop spacer for straight flue (multi-pack of 12)	HTI 1	\$ 690	Y	Y	14	Y	Y

SL1100 Wood Pipe - Single Pack - Chimney Air Kits/Flex Duct Dimensions: 11" Inner / 13" Outer

		Disc. Code	MSRP USD	004 IA	010 PA	014 CA	016 NC	EXP
CAK8A	Chimney air kit (For use with BIR42 and RUTHERFORD-42, ODCASTLEWD-42)	HTI 1	\$ 145	Y	Y	14	14	Y

SL1100 Wood Pipe - Single Pack - Elbow

		Disc. Code	MSRP USD	004 IA	010 PA	014 CA	016 NC	EXP
SL1130	30 Degree elbow (offset and return)	HTI 1	\$ 364	Y	Y	Y	Y	Y

SL1100 Wood Pipe - Single Pack - Firestop/Straps/Support

		Disc. Code	MSRP USD	004 IA	010 PA	014 CA	016 NC	EXP
FS538	Flat Firestop Spacer for SL1100 and SL400 Series Pipe	HTI 1	\$ 65	Y	Y	Y	Y	Y
FS540	AC30 Degree firestop spacer for SL1100 and SL400 Series Pipe	HTI 1	\$ 77	Y	21	14	14	Y
SL11	6" (152mm) chimney stabilizer	HTI 1	\$ 164	Y	Y	14	14	Y

SL1100 Wood Pipe - Single Pack - Shield/Flashing/Collars

		Disc. Code	MSRP USD	004 IA	010 PA	014 CA	016 NC	EXP
AS10	Attic insulation shield, straight flue (firestop not included) for SL1100 and SL400 Series Pipe	HTI 1	\$ 110	Y	Y	Y	Y	Y
RF570	Roof flashing, 0 - 6/12 pitch for SL1100 and SL400 Series Pipe	HTI 1	\$ 181	Y	Y	Y	Y	Y
RF571	Roof flashing, 7/12 - 12/12 pitch for SL1100 and SL400 Series Pipe	HTI 1	\$ 276	Y	Y	Y	Y	Y

SL1100 Wood Pipe - Single Pack - Straight Section Dimensions: 11" Inner / 13" Outer

		Disc. Code	MSRP USD	004 IA	010 PA	014 CA	016 NC	EXP
SL1106	6" chimney section	HTI 1	\$ 101	Y	Y	Y	Y	Y
SL1112	12" (305mm) pipe section	HTI 1	\$ 110	Y	Y	Y	Y	Y
SL1118	18" (455mm) pipe section	HTI 1	\$ 148	Y	Y	Y	Y	Y
SL1136	36" (915mm) pipe section	HTI 1	\$ 215	Y	Y	Y	Y	Y
SL1148	48" (1220mm) pipe section	HTI 1	\$ 295	Y	Y	Y	Y	Y

SL1100 Wood Pipe Term Kits Acc - Sng Pk - Shield/Flashing/Collars

		Disc. Code	MSRP USD	004 IA	010 PA	014 CA	016 NC	EXP
SL1100-RDS	Roof Deck Underside Insulation Shield	HTI 1	\$ 257	8	21	14	14	Y

SL1100 Wood Pipe Term Kits Acc - Sng Pk - Termination Dimensions: 11" Inner / 13" Outer

		Disc. Code	MSRP USD	004 IA	010 PA	014 CA	016 NC	EXP
TR11	Round termination cap (includes 34508 storm collar)	HTI 1	\$ 267	Y	Y	Y	Y	Y
TR11T-B	Round telescoping termination cap with storm collar	HTI 1	\$ 403	Y	Y	Y	Y	Y
ST1175	Square termination cap, painted black	HTI 1	\$ 418	Y	Y	14	Y	Y
TCT1175	Terra cotta vertical termination cap	HTI 1	\$ 609	Y	21	21	21	N
ST1175SS	Stainless steel ST1175 termination cap	HTI 1	\$ 793	Y	21	14	14	Y

SL300 Series Pipe - Comp - Multi-Pk - Firestop/Straps/Support Dimensions: 8" Inner / 10.5" Outer

		Disc. Code	MSRP USD	004 IA	010 PA	014 CA	016 NC	EXP
JB877	Joint band (package of 3)	HTI 1	\$ 71	Y	Y	14	14	Y
CB876	SL300 Series Chimney bracket (package of 3)	HTI 1	\$ 92	Y	Y	14	Y	Y
FS338M	Straight firestop spacer (multi-pack of 10)	HTI 1	\$ 391	Y	Y	Y	Y	Y

SL300 Series Pipe - Comp - Multi-Pk - Shield/Flashing/Collars

		Disc. Code	MSRP USD	004 IA	010 PA	014 CA	016 NC	EXP
RF370M	Roof flashing, 0 - 6/12 pitch (multi-pack of 5)	HTI 1	\$ 458	Y	21	14	14	Y

SL300 Series Pipe - Comp - SngPk - Chimney Air Kits/Flex Duct Dimensions: 8" Inner / 10.5" Outer

		Disc. Code	MSRP USD	004 IA	010 PA	014 CA	016 NC	EXP
CAK4A	Chimney air kit (for SL300 series chimney systems only)	HTI 1	\$ 120	Y	Y	14	14	Y
SL3FL96	FLASHING SL300 SERIES 4X8	HTI 1	\$ 350	Y	Y	14	Y	N

SL300 Series Pipe - Comp - SngPk - Elbow

		Disc. Code	MSRP USD	004 IA	010 PA	014 CA	016 NC	EXP
SL315	15 Degree elbow (offset and return)	HTI 1	\$ 215	Y	Y	Y	14	Y
SL330	30 Degree elbow (offset and return)	HTI 1	\$ 240	Y	Y	Y	Y	Y

SL300 Series Pipe - Comp - SngPk - Firestop/Straps/Support

		Disc. Code	MSRP USD	004 IA	010 PA	014 CA	016 NC	EXP
FS338	Firestop for straight up flue	HTI 1	\$ 52	Y	Y	Y	Y	Y
FS339	Firestop for 15 Degree angular flue	HTI 1	\$ 71	8	21	14	14	Y
FS340	Firestop for 30 Degree angular flue	HTI 1	\$ 106	Y	Y	14	14	Y
SL3	6" (200mm) flue support section	HTI 1	\$ 112	Y	Y	14	14	Y
WS30	30 Degree wall firestop spacer	HTI 1	\$ 161	8	21	14	14	Y

SL300 Series Pipe - Comp - SngPk - Shield/Flashing/Collars

		Disc. Code	MSRP USD	004 IA	010 PA	014 CA	016 NC	EXP
AS8	Attic insulation shield, straight flue (firestop not included)	HTI 1	\$ 109	Y	Y	Y	Y	Y
RF370	0-6/12 pitch roof flashing	HTI 1	\$ 162	Y	Y	Y	Y	Y
RF371	7/12 - 12/12 pitch roof flashing	HTI 1	\$ 257	Y	Y	Y	Y	Y
SL300-RDS	Roof Deck Underside Insulation Shield	HTI 1	\$ 257	8	21	14	14	Y

SL300 Series Pipe - Comp - SngPk - Straight Section

		Disc. Code	MSRP USD	004 IA	010 PA	014 CA	016 NC	EXP
SL306	6" chimney section	HTI 1	\$ 77	Y	Y	Y	Y	Y
SL312	12" (305mm) pipe section	HTI 1	\$ 95	Y	Y	Y	Y	Y
SL318	18" (455mm) pipe section	HTI 1	\$ 105	Y	Y	Y	Y	Y
SL318A	18" chimney section, aluminized (for Canada only)	HTI 1	\$ 106	8	21	14	14	Y
SL324	24" chimney section	HTI 1	\$ 128	Y	Y	Y	Y	Y
SL336A	36" chimney section, aluminized (for Canada only)	HTI 1	\$ 156	Y	21	14	14	Y
SL336	36" (915mm) pipe section	HTI 1	\$ 156	Y	Y	Y	Y	Y
SL348	4 ft. (1220mm) pipe section	HTI 1	\$ 187	Y	Y	Y	Y	Y

SL300 Series Pipe - Term Kits & Acc - Sng Pk - Termination Dimensions: 8" Inner / 10.5" Outer

		Disc. Code	MSRP USD	004 IA	010 PA	014 CA	016 NC	EXP
TR344	Round termination cap (includes 32738 storm collar)	HTI 1	\$ 174	Y	Y	Y	Y	Y
TR342-B	Round telescoping termination cap with storm collar	HTI 1	\$ 240	Y	Y	Y	Y	Y
TS345	Trapezoid termination cap	HTI 1	\$ 335	Y	21	Y	14	Y
TS345P	Trapezoid termination cap, painted black	HTI 1	\$ 403	Y	Y	14	Y	Y
ST375	Square termination cap, painted black	HTI 1	\$ 403	Y	Y	Y	Y	Y
TCT375	Terra cotta vertical termination cap, 8"	HTI 1	\$ 679	Y	14	21	21	N
ST375SS	Stainless steel ST375 termination cap	HTI 1	\$ 679	Y	Y	14	14	Y

SL400 Series Pipe - Comp - SngPk - Adapter/Increaser/Tee

		Disc. Code	MSRP USD	004 IA	010 PA	014 CA	016 NC	EXP
SLA10	11" to 10" adapter	HTI 1	\$ 215	Y	21	14	14	Y

SL400 Series Pipe - Comp - SngPk - Elbow

		Disc. Code	MSRP USD	004 IA	010 PA	014 CA	016 NC	EXP
SL430	30 degree elbow (offset and return)	HTI 1	\$ 391	Y	21	14	14	Y

SL400 Series Pipe - Comp - SngPk - Straight Section Dimensions: 10" Inner / 13" Outer

		Disc. Code	MSRP USD	004 IA	010 PA	014 CA	016 NC	EXP
SL406	6" (150mm) chimney section	HTI 1	\$ 125	Y	21	14	14	Y
SL412	12" (305mm) chimney section	HTI 1	\$ 137	Y	21	14	14	Y
SL418	18" (460mm) chimney section	HTI 1	\$ 174	Y	21	14	14	Y
SL4	6" (150mm) flue support section	HTI 1	\$ 229	8	21	14	14	Y
SL436	36" (915mm) chimney section	HTI 1	\$ 240	Y	21	14	14	Y
SL448	48" (1220mm) chimney section	HTI 1	\$ 308	Y	Y	14	14	Y

SL400 Series Pipe - Term Kits & Acc - Sng Pk - Chimney Air Kits/Flex Duct

		Disc. Code	MSRP USD	004 IA	010 PA	014 CA	016 NC	EXP
CAK5A	Chimney air kit for SL1100 and SL400 series pipe (required in Canada)	HTI 1	\$ 135	Y	Y	14	14	Y

SL400 Series Pipe - Term Kits & Acc - Sng Pk - Termination Dimensions: 10" Inner / 13" Outer

		Disc. Code	MSRP USD	004 IA	010 PA	014 CA	016 NC	EXP
TR444	Round termination cap with storm collar	HTI 1	\$ 257	Y	21	14	14	Y

6" DuraFlex 304SS - Adapter/Increaser/Tee

		Disc. Code	MSRP USD	004 IA	010 PA	014 CA	016 NC	EXP
DV-6DFS-FC	6" Duraflex Connector	HTI 5	\$ 36	Y	14	28	14	N

6" DuraFlex 304SS - Anchor

		Disc. Code	MSRP USD	004 IA	010 PA	014 CA	016 NC	EXP
DV-6DFS-TPSC	6" Duraflex Top Plate	HTI 5	\$ 178	35	14	28	14	N

6" DuraFlex 304SS - Straight Section

		Disc. Code	MSRP USD	004 IA	010 PA	014 CA	016 NC	EXP
DV-6DF304-15	6 X 15' length	HTI 5	\$ 564	35	35	28	35	N
DV-6DF304-20	6 X 20" length	HTI 5	\$ 736	Y	14	14	14	N
DV-6DF304-25	6 X 25' length	HTI 5	\$ 920	Y	14	28	14	N
DV-6DF304-30	6 X 30' length	HTI 5	\$ 1,114	Y	14	28	14	N

6" DuraFlex 304SS - Termination

		Disc. Code	MSRP USD	004 IA	010 PA	014 CA	016 NC	EXP
DV-DFS-SA	3-8 Spark Arrestor	HTI 5	\$ 31	Y	14	28	14	N
DV-6DFS-VCRC	6" DuraFlex Vertical Cap	HTI 5	\$ 89	Y	14	28	14	N

Vermont Castings - Wood Stove Enamel Venting

		Disc. Code	MSRP USD	004 IA	010 PA	014 CA	016 NC	EXP
0000191	6" and 8" Chimney Connector Heat Shield--24"	VMT 2	\$ 85	21	21	28	21	Y
0003670	6" x 12" Chimney Connectors - Biscuit	VMT 2	\$ 179	Y	14	14	14	N
0003691	6" x 12" Chimney Connectors - Majolica Brown	VMT 2	\$ 179	Y	14	14	14	Y
0003679	6" Slip - 1 1/4" - 17" Length - Biscuit	VMT 2	\$ 239	Y	21	14	14	N
0003694	6" Slip - 1 1/4" - 17" Length - Majolica Brown	VMT 2	\$ 239	Y	14	14	14	Y
0003682	6" x 6 3/4" 45 Degree Elbow - Biscuit	VMT 2	\$ 249	Y	14	21	21	N
0003695	6" x 6 3/4" 45 Degree Elbow - Majolica Brown	VMT 2	\$ 249	Y	14	21	21	Y
0003696	6" x 12" Chimney Connectors - Bordeaux	VMT 2	\$ 249	Y	14	14	21	N
0003690	Oval to 6"round adapter, 6"w x11"h - Majolica Brown	VCG 2	\$ 257	Y	28	28	14	Y
0003673	6" x 24" Chimney Connectors - Biscuit	VMT 2	\$ 279	Y	14	14	14	N
0003692	6" x 24" Chimney Connectors - Majolica Brown	VMT 2	\$ 279	Y	28	28	14	Y
0003693	6" x 7" 90 Degree Elbow - Majolica Brown	VMT 2	\$ 289	Y	14	14	14	Y
0003676	6" x 7" 90 Degree Elbow - Biscuit	VMT 2	\$ 289	Y	14	14	14	N
0003699	6" Slip - 1 1/4" - 17" Length - Bordeaux	VMT 2	\$ 289	Y	14	14	14	N
0003701	Oval to 6"round adapter, 6"w x11"h - Bordeaux	VCG 2	\$ 308	Y	14	14	14	Y
0003700	6" x 6 3/4" 45 Degree Elbow - Bordeaux	VMT 2	\$ 319	Y	14	14	14	N
0003697	6" x 24" Chimney Connectors - Bordeaux	VMT 2	\$ 339	Y	14	14	14	N
0003698	6" x 7" 90 Degree Elbow - Bordeaux	VMT 2	\$ 369	Y	14	14	14	N

6" DuraBlack - Adapter/Increaser/Tee

		Disc. Code	MSRP USD	004 IA	010 PA	014 CA	016 NC	EXP
DV-6DBK-AD	Stovetop Adapter -Black	HTI 5	\$ 18	35	35	28	35	N
DV-6DBK-ADOR	Oval to Round Adapter	HTI 5	\$ 52	35	35	28	35	N
DV-6DBK-ADDB	Double-Skirted Stovetop Adapter - Black	HTI 5	\$ 64	35	35	28	35	N
DV-6DBK-X7	Increaser 6"- 7"	HTI 5	\$ 68	35	35	28	35	N

6" DuraTech - Adapter/Increaser/Tee

		Disc. Code	MSRP USD	004 IA	010 PA	014 CA	016 NC	EXP
DV-6DT-ST	Standard Tee w/Cap GA	HTI 5	\$ 415	35	35	28	35	N
DV-6DT-STSS	Standard Tee w/Cap SS	HTI 5	\$ 521	35	35	28	35	N

6" DuraTech - Anchor

		Disc. Code	MSRP USD	004 IA	010 PA	014 CA	016 NC	EXP
DV-6DT-AP	6" DuraTech anchor plate	HTI 5	\$ 133	35	35	28	35	N
DV-6DT-AP13X21	13x21 trans anchor plate	HTI 5	\$ 691	35	35	28	35	N
DV-6DT-AP17X17	17x17 trans anchor plate	HTI 5	\$ 694	35	35	28	35	N
DV-6DT-AP17X21	17x21 trans anchor plate	HTI 5	\$ 704	35	35	28	35	N

6" DuraTech - Elbow

		Disc. Code	MSRP USD	004 IA	010 PA	014 CA	016 NC	EXP
DV-6DT-E15K	15 Degree Elbow Kit - GA (includes 2 Elbows & 1 Elbow Strap)	HTI 5	\$ 625	35	35	28	35	N
DV-6DT-E30K	30 Degree Elbow Kit - GA (includes 2 Elbows & 1 Elbow Strap)	HTI 5	\$ 742	35	35	28	35	N
DV-6DT-E15KSS	15 Degree Elbow Kit - SS (includes 2 Elbows & 1 Elbow Strap)	HTI 5	\$ 766	35	35	28	35	N
DV-6DT-E30KSS	30 Degree Elbow Kit - SS (includes 2 Elbows & 1 Elbow Strap)	HTI 5	\$ 1,020	35	35	28	35	N

6" DuraTech - Firestop/Straps/Support

		Disc. Code	MSRP USD	004 IA	010 PA	014 CA	016 NC	EXP
DV-6DT-FRS	Firestop Radiation Shield	HTI 5	\$ 128	Y	14	28	14	N
DV-6DT-WSSS	Adjustable Wall Strap - SS	HTI 5	\$ 151	35	35	28	35	N
DV-6DT-ARS	6" & 8" Adjustable Roof Support	HTI 5	\$ 157	35	35	28	35	Y
DV-6DT-WT	Wall Thimble	HTI 5	\$ 163	Y	14	28	14	N
DV-6DT-IS	Attic Insulation Shield	HTI 5	\$ 166	Y	14	28	14	N
DV-6DT-RCS	Round Ceiling Support Box	HTI 5	\$ 169	35	35	28	35	N
DV-6DT-TSB	Adjustable Tee Support Bracket - GA	HTI 5	\$ 208	35	35	28	35	N
DV-6DT-FCS	Flat Ceiling Support Box	HTI 5	\$ 219	35	35	28	35	N
DV-6DT-CS11	Square Ceiling Support Box - 11"	HTI 5	\$ 322	Y	14	Y	14	N
DV-6DT-CS24R	Square Ceiling Support Box - 24" (Reduced Clearance)	HTI 5	\$ 336	35	35	28	35	N
DV-6DT-CS24	Square Ceiling Support Box - 24"	HTI 5	\$ 357	Y	14	Y	14	N
DV-6DT-CS36	Square Ceiling Support Box - 36"	HTI 5	\$ 394	35	35	28	35	N
DV-6DT-TSBSS	Adjustable Tee Support Bracket - SS	HTI 5	\$ 502	35	35	28	35	N

6" DuraTech - Shield/Flashing/Collars

		Disc. Code	MSRP USD	004 IA	010 PA	014 CA	016 NC	EXP
DV-6DT-LB	Locking Band	HTI 5	\$ 22	Y	Y	28	14	N
DV-5DT-SC	Storm Collar 5" - 6"	HTI 5	\$ 31	Y	Y	Y	14	N
DV-6DT-WTSS	Wall Thimble Exterior Trim - SS	HTI 5	\$ 95	35	35	28	35	N
DV-6DT-FC	Finishing Collar	HTI 5	\$ 99	Y	14	28	14	N
DV-6DT-CTF	Chase top flashing	HTI 5	\$ 111	35	35	28	35	N
DV-6DT-RSTC12	Trim Collar for Roof Support 10/12 - 12/12	HTI 5	\$ 128	35	35	28	35	N
DV-6DT-RSTC9	Trim Collar for Roof Support 7/12 - 9/12	HTI 5	\$ 128	35	35	28	35	N
DV-6DT-RSTC6	Trim Collar for Roof Support 4/12 - 6/12	HTI 5	\$ 128	35	35	28	35	N
DV-6DT-RSTC3	Trim Collar for Roof Support 0/12 - 3/12	HTI 5	\$ 128	35	35	28	35	N
DV-6DT-F6	Adjustable Roof Flashing 0/12 - 6/12	HTI 5	\$ 170	Y	14	Y	14	N
DV-6DT-RRS	Roof Radiation Shield	HTI 5	\$ 179	35	35	28	35	N
DV-6DT-F12	Adjustable Roof Flashing 7/12 - 12/12	HTI 5	\$ 220	Y	14	28	14	N
DV-6DT-F6L	Large Base Adjustable Roof Flashing 0/12 - 6/12	HTI 5	\$ 226	35	35	28	35	N
DV-6DT-FF	Flat Roof Flashing	HTI 5	\$ 228	35	35	28	35	N
DV-6DT-F6DSA	DSA Adjustable Roof Flashing 0/12-6/12	HTI 5	\$ 236	35	35	28	35	N
DV-6DT-F12L	Large Base Adjustable Roof Flashing 7/12 - 12/12	HTI 5	\$ 300	35	35	28	35	N
DV-6DT-F18	Adjustable Roof Flashing 13/12 - 18/12	HTI 5	\$ 326	35	35	28	35	N
DV-6DT-F12DSA	DSA Adjustable Roof Flashing 7/12-12/12	HTI 5	\$ 376	35	35	28	35	N
DV-6DT-F24	Adjustable Roof Flashing 19/12 - 24/12	HTI 5	\$ 423	35	35	28	35	N

6" DuraTech - Straight Section

		Disc. Code	MSRP USD	004 IA	010 PA	014 CA	016 NC	EXP
DV-6DT-06	6" Chimney Pipe - GA	HTI 5	\$ 109	35	35	28	35	N
DV-6DT-09	9" Chimney Pipe - GA	HTI 5	\$ 134	35	35	28	35	N
DV-6DT-06SS	6" Chimney Pipe - SS	HTI 5	\$ 141	35	35	28	35	N
DV-6DT-09SS	9" Chimney Pipe - SS	HTI 5	\$ 151	35	35	28	35	N
DV-6DT-12	12" Chimney Pipe - GA	HTI 5	\$ 159	Y	14	28	14	N
DV-6DT-12SS	12" Chimney Pipe - SS	HTI 5	\$ 160	Y	14	28	14	N
DV-6DT-18	18" Chimney Pipe - GA	HTI 5	\$ 200	35	35	28	35	N
DV-6DT-18SS	18" Chimney Pipe - SS	HTI 5	\$ 219	35	35	28	35	N
DV-6DT-24	24" Chimney Pipe - GA	HTI 5	\$ 254	Y	14	Y	14	N
DV-6DT-24SS	24" Chimney Pipe - SS	HTI 5	\$ 291	Y	14	28	14	N
DV-6DT-36	36" Chimney Pipe - GA	HTI 5	\$ 332	Y	14	Y	14	N
DV-6DT-36SS	36" Chimney Pipe - SS	HTI 5	\$ 388	Y	14	28	14	N
DV-6DT-48	48" Chimney Pipe - GA	HTI 5	\$ 411	Y	14	Y	14	N
DV-6DT-21TA	Adjustable Pipe 14"-21"	HTI 5	\$ 457	35	35	28	35	N
DV-6DT-48SS	48" Chimney Pipe - SS	HTI 5	\$ 499	Y	Y	Y	14	N
DV-6DT-60CF	60" Chimney Pipe - GA (CF)	HTI 5	\$ 515	35	35	28	35	N

6" DuraTech - Termination

		Disc. Code	MSRP USD	004 IA	010 PA	014 CA	016 NC	EXP
DV-5DT-SA	Spark Arrestor	HTI 5	\$ 39	Y	14	28	14	N
DV-6DT-VC	Chimney Cap	HTI 5	\$ 186	Y	Y	Y	14	N
DV-6DT-SP	Snow Splitter	HTI 5	\$ 249	35	35	28	35	N

6" DVL - Adapter/Increaser/Tee

		Disc. Code	MSRP USD	004 IA	010 PA	014 CA	016 NC	EXP
DV-6DVL-ADC	DVL/DuraBlack Adapter w/Trim	HTI 5	\$ 63	Y	14	Y	14	Y
DV-6DVL-AD	Adapter Section No Damper	HTI 5	\$ 97	Y	Y	Y	14	N
DV-6DVL-ADWD	Adapter Section with Damper	HTI 5	\$ 133	35	35	28	35	N
DV-6DVL-T	Double-Wall Black Tee w/Clean-Out Cap	HTI 5	\$ 185	35	35	28	35	N

6" DVL - Elbow

		Disc. Code	MSRP USD	004 IA	010 PA	014 CA	016 NC	EXP
DV-6DVL-E45	45 Degree Double-Wall Black Elbow	HTI 5	\$ 144	Y	14	Y	14	N
DV-6DVL-E90	90 Degree Double-Wall Black Elbow	HTI 5	\$ 214	Y	14	28	14	N

6" DVL - Straight Section

		Disc. Code	MSRP USD	004 IA	010 PA	014 CA	016 NC	EXP
DV-6DVL-06	6" Double-Wall Black Pipe	HTI 5	\$ 103	Y	14	28	14	N
DV-6DVL-12	12" Double-Wall Black Pipe	HTI 5	\$ 110	Y	14	28	14	N
DV-6DVL-6ADJ	6" Double-Wall Adjustable Black Pipe	HTI 5	\$ 112	Y	14	28	14	N
DV-6DVL-18	18" Double-Wall Black Pipe	HTI 5	\$ 130	Y	14	28	14	N
DV-6DVL-12ADJ	12" Double-Wall Adjustable Black Pipe	HTI 5	\$ 136	Y	14	28	14	N
DV-6DVL-24	24" Double-Wall Black Pipe	HTI 5	\$ 181	Y	14	Y	14	N
DV-6DVL-48	48" Double-Wall Black Pipe	HTI 5	\$ 278	Y	14	Y	14	N
DV-6DVL-46TA	Telescoping Length 29" - 46"	HTI 5	\$ 328	Y	14	Y	14	N
DV-6DVL-68TA	Telescoping Length 40" - 68"	HTI 5	\$ 435	Y	14	Y	14	N

14" Dura Vent DuraChimney II - Anchor

		Disc. Code	MSRP USD	004 IA	010 PA	014 CA	016 NC	EXP
14DCA-AP	Anchor plate	HTI 1	\$ 370	35	35	28	35	N
14DCA-APD	Anchor plate w/damper	HTI 1	\$ 865	35	35	Y	35	N

Venting - Discontinued

		Disc. Code	MSRP USD	004 IA	010 PA	014 CA	016 NC	EXP
DV-4PVP-CO1	4* CLEAN OUT TEE W/ CAP	HTI 5	\$ 79	35	35	28	35	Y
DV-4PVP-COB1	4*CLEAN OUT TEE W/CAP BLK	HTI 5	\$ 97	35	35	28	35	Y
DV-4PVP-HC2	HORIZONTAL CAP	HTI 5	\$ 99	Y	14	28	14	Y
DV-4PVP-T31	INC. TEE W/ CLEAN OUT CAP	HTI 5	\$ 212	35	35	28	35	Y
DV-4PVP-T1	SLG TEE W/ CLEAN OUT CAP	HTI 5	\$ 218	35	35	28	35	Y
DV-6DT-XRS	6DT AD EXTENDED ROOF BRKT	HTI 5	\$ 225	Y	14	Y	14	Y
DV-4PVP-T3B1	BLK INC TEE W/ CLEAN OUT	HTI 5	\$ 237	35	35	28	35	Y
DV-4PVP-TB1	BLK SIN TEE W/ CLEAN OUT	HTI 5	\$ 240	35	35	28	35	Y

Hearth & Home Technologies

Termination Kits

Stocked Item/Lead Time

004=Mt. Pleasant RDC
 010=Kutztown RDC
 014=Sacramento RDC
 016=Charlotte RDC

EXP=Factory Expedite Program

Page printed 2/1/2024 3:05:35 PM CST

* Please Contact Who You Purchase This Through for MSRP Pricing

Prices in USD

Non-stock and custom product cannot be cancelled.

Customer is responsible for freight for orders made outside of assigned RDC facility.

Legacy Components-MultiPk - Elbow

		Disc. Code	MSRP USD	004 IA	010 PA	014 CA	016 NC	EXP
DVP90M	90 degree elbow (multi-pack of 4)(for use with legacy Majestic unit made prior to HHT)	HTI 1	\$ 525	Y	14	Y	14	Y

Legacy Components-MultiPk - Straight Section

		Disc. Code	MSRP USD	004 IA	010 PA	014 CA	016 NC	EXP
SLP-20TPM	20" Termination pipe (multi-pack of 6)	VCG 1	\$ 387	8	21	14	14	Y
DVP-RVT12AM	9"-12" adj. termination pipe (multi-pack of 6)	VCG 1	\$ 484	8	21	14	14	Y
SLP-RVT12AM	9" - 12" adj. termination pipe (multi-pack of 6)	VCG 1	\$ 484	8	21	14	14	Y

Legacy Termination Kits - Multi Pk - Termination

		Disc. Code	MSRP USD	004 IA	010 PA	014 CA	016 NC	EXP
SLP-RVTM	Rear Vent Termination includes adj Termination Cap, 1" firestop (multi-pack of 4)	VCG 1	\$ 957	8	Y	14	14	Y
DVP-RVTM	Rear Vent Termination includes adj Termination Cap, 1" firestop (multi-pack of 4)	VCG 1	\$ 957	8	21	14	14	Y

Legacy Termination Kits - Single Pk - Termination

		Disc. Code	MSRP USD	004 IA	010 PA	014 CA	016 NC	EXP
AK4	Outside Combustion Air Kit	VCG 1	\$ 91	Y	14	14	Y	N
DVP-RVTK	Rear Vent Termination Kit includes adj Termination Cap, 1" firestop, 9" - 12" adj. termination pipe	VCG 1	\$ 308	Y	Y	14	Y	Y
SLP-RVTK	Rear Vent Termination Kit includes adj Termination Cap, 1" firestop, 9" - 12" adj. termination pipe	HTI 1	\$ 308	Y	Y	14	Y	Y
DVP-HVTK	Horizontal Vent Termination Kit includes adj Termination Cap, 1" firestop, 3" firestop, 90 degree elbow, 9" - 12" adj. termination pipe	VCG 1	\$ 432	Y	14	14	Y	Y
SLP-HVTK	Horizontal Vent Termination Kit includes adj Termination Cap, 1" firestop, 3" firestop, 90 degree elbow, 9" - 12" adj. termination pipe	VCG 1	\$ 432	Y	14	14	Y	Y
DVP-TRFK	Thru roof flex termination kit includes DVP-TVHW, 24" DVP pipe/roof support and flex adapters	VCG 1	\$ 484	8	21	14	14	Y
SLP-TRFK	Through roof flex termination kit includes SLP-TVHW, 24" SLP pipe, roof support and flex adapters	MAJ 1	\$ 486	8	21	14	14	Y
SLP-HSFTK	Horizontal Vent Termination Kit includes adj Termination Cap, 1" firestop, 42" Flex and adapters	VCG 1	\$ 535	8	21	14	14	Y
DVP-HSFTK	Horizontal Vent Termination Kit includes adj Termination Cap, 1" firestop, 30" Flex and adapters	VCG 1	\$ 535	8	21	14	14	Y

Hearth & Home Technologies

Fireplace - Gas - Single-Sided

Stocked Item/Lead Time

004=Mt. Pleasant RDC
010=Kutztown RDC
014=Sacramento RDC
016=Charlotte RDC

EXP=Factory Expedite Program

Page printed 2/1/2024 3:05:35 PM CST

Future pricing effective for shipments on or after 03/31/2024

* Please Contact Who You Purchase This Through for MSRP Pricing

Prices in USD

Non-stock and custom product cannot be cancelled.

Customer is responsible for freight for orders made outside of assigned RDC facility.

DV Linear 36

Includes:

- 16,500 Btu/Hour Input (NG/LP)
- IntelliFire ignition system
- Black firescreen
- Onyx media
- Tempered glass
- Junction box
- Battery backup
- Gas flex connector
- 4" x 6-5/8" top vent collar



No additional items required to complete.

		Disc. Code	MSRP USD	004 IA	010 PA	014 CA	016 NC	EXP
DVLINEAR36	DV Linear 36" direct vent fireplace with IntelliFire (NG)	HTI 1	\$ 2,279	Y	Y	Y	Y	N

Conversion Kit

Conversion Kit

LPK-DVLIN36	LP conversion kit	HTI 1	\$ 99	14	14	14	14	Y
-------------	-------------------	-------	-------	----	----	----	----	---

Fronts - Non-Operable

Clean Face Trim

CFTF-36-BK	Clean Face Trim - Black	HTI 1	\$ 449	Y	Y	Y	14	Y
------------	-------------------------	-------	--------	---	---	---	----	---



Clean Face Trim

Heat Management

Heat Management

PH-SIDETRIM	Passive Heat trim kit for side discharge (includes 2 side registers)(Starting collars sold separately)	HTI 1	\$ 108	Y	Y	Y	Y	Y
PH-FRTRIM-36	Passive Heat Vent Trim Kit For Front Discharge (36")(Starting collars sold separately)	HTI 1	\$ 189	Y	Y	Y	21	Y
PH-LINEAR	Starting Collars for Non-Ducted Passive Heat (Required when using passive heat - For use with Front, Side, Top Discharges)	HTI 1	\$ 189	Y	Y	Y	Y	Y

Control, remotes, wall switches

Remote/Wall Switch/Wall Thermostat

RCT-MLT-HHT	IPI Remote Control (on/off, fan speed, flame control, temperature readout, thermostat mode, timer mode)	HTI 1	\$	399	Y	Y	Y	Y	Y
-------------	---------------------------------------------------------------------------------------------------------	-------	----	-----	---	---	---	---	---

Smart Stat Remote Control

SMART-STAT-HHT	Remote Control - IPI or SP (on/off, temp readout, thermostat mode, timer mode)	HTI 1	\$	289	Y	Y	Y	Y	Y
----------------	--------------------------------------------------------------------------------	-------	----	-----	---	---	---	---	---

Venting Notes

Requires 6-5/8" SLP pipe. See venting section.

Approved for use with PVLP-SLP, PVI-SLP-B and PVV-SLP with PV-IPI-CK kit, power vent wire harness and RC100, 200 or 300 control (order separately). See venting section of manual.

DV3732

Includes:

- 13,500-19,000 Btu/Hour Input (NG)
- 14,500-18,000 Btu/Hour Input (LP)
- 5" x 8" rear vent collar
- 4" x 6-5/8" top vent collar
- 5 ceramic logs
- Full firescreen
- Black hood
- Gas flex connector
- Glowing embers
- Battery backup
- Junction box
- 12' control wire
- Tempered glass
- IntelliFire ignition



No additional items required to complete.

		Disc. Code	MSRP USD	004 IA	010 PA	014 CA	016 NC	EXP
DV3732-B	DV3732 Top/rear direct vent fireplace with IntelliFire (NG)	HHR 1	\$ 1,969	Y	Y	Y	Y	N
DV3732L-B	DV3732 Top/rear direct vent fireplace with IntelliFire (LP)	HHR 1	\$ 2,039	Y	Y	Y	Y	N

Fans

Fan

GFK-160C	Fan kit 160 CFM (fan only)	HTI 1	\$ 259	Y	Y	Y	Y	Y
GFK-160A	Fan kit 160 CFM (includes rheostat and temperature sensor)	HTI 1	\$ 319	Y	Y	Y	Y	Y

Trim Kits

Trim Kit 550

550-TRIM3-BK-B	Trim Kit, 3 Sided - Black (not for use with Clean Face Kit)	HTI 1	\$ 299	Y	Y	Y	14	Y
550-TRIM4-BK-B	Trim Kit, 4 Sided - Black (not for use with Clean Face Kit)	HTI 1	\$ 359	Y	14	Y	14	Y

Control, remotes, wall switches

Remote/Wall Switch/Wall Thermostat

RCT-MLT-HHT	IPI Remote Control (on/off, fan speed, flame control, temperature readout, thermostat mode, timer mode)	HTI 1	\$ 399	Y	Y	Y	Y	Y
-------------	---------------------------------------------------------------------------------------------------------	-------	--------	---	---	---	---	---

Smart Stat Remote Control

SMART-STAT-HHT	Remote Control - IPI or SP (on/off, temp readout, thermostat mode, timer mode)	HTI 1	\$ 289	Y	Y	Y	Y	Y
----------------	--------------------------------------------------------------------------------	-------	--------	---	---	---	---	---

Venting Notes

Requires SLP series or SLP-Flex series pipe when venting off top of unit. See Venting section

Requires DVP series pipe when venting off rear of unit. See Venting section.

Approved for use with PVLP-SLP, PVI-SLP-B and PVV-SLP with PV-IPI-CK kit, power vent wire harness and RC100, 200 or 300 control (order separately). See venting section of manual.

DV4236

Includes:

- 15,000 - 22,000 Btu/Hour Input (NG)
- 16,500 - 20,500 Btu/Hour Input (LP)
- 5" x 8" rear vent collar
- 4" x 6-5/8" top vent collar
- 6 ceramic logs
- Full firescreen
- Black hood
- Gas flex connector
- Glowing embers
- Battery backup
- Junction box
- 12' control wire
- Tempered glass
- IntelliFire ignition



No additional items required to complete.

		Disc. Code	MSRP USD	004 IA	010 PA	014 CA	016 NC	EXP
DV4236-B	DV4236 Top/rear direct vent fireplace with IntelliFire (NG)	HHR 1	\$ 2,199	Y	Y	Y	Y	N

Conversion Kit

Conversion Kit

LPK-4236	LP conversion kit- DV4236	HTI 1	\$ 99	Y	Y	Y	Y	Y
----------	---------------------------	-------	-------	---	---	---	---	---

Fans

Fan

GFK-160C	Fan kit 160 CFM (fan only)	HTI 1	\$ 259	Y	Y	Y	Y	Y
GFK-160A	Fan kit 160 CFM (includes rheostat and temperature sensor)	HTI 1	\$ 319	Y	Y	Y	Y	Y

Trim Kits

Trim Kits

750-TRIM3-BK-B	Trim Kit, 3 Sided - Black (not for use with Clean Face Kit)	HTI 1	\$ 319	Y	14	14	14	Y
750-TRIM4-BK-B	Trim Kit, 4 Sided - Black (not for use with Clean Face Kit)	HTI 1	\$ 369	Y	14	Y	14	Y

Control, remotes, wall switches

Remote/Wall Switch/Wall Thermostat

RCT-MLT-HHT	IPI Remote Control (on/off, fan speed, flame control, temperature readout, thermostat mode, timer mode)	HTI 1	\$ 399	Y	Y	Y	Y	Y
-------------	---------------------------------------------------------------------------------------------------------	-------	--------	---	---	---	---	---

Smart Stat Remote Control

SMART-STAT-HHT	Remote Control - IPI or SP (on/off, temp readout, thermostat mode, timer mode)	HTI 1	\$ 289	Y	Y	Y	Y	Y
----------------	--------------------------------------------------------------------------------	-------	--------	---	---	---	---	---

Venting Notes

Requires SLP series or SLP-Flex series pipe when venting off top of unit. See Venting section

Requires DVP series pipe when venting off rear of unit. See Venting section.

Approved for use with PVLP-SLP, PVI-SLP-B and PVV-SLP with PV-IPI-CK kit, power vent wire harness and RC100, 200 or 300 control (order separately). See venting section of manual.

Reveal 36

Includes:

- 40,000 Btu/Hour Input (NG)
- Traditional Refractory
- Glowing embers, lava rock, vermiculite
- 6 ceramic fiber logs
- Black hood
- Outside air kit
- Junction box
- Gas flex connector
- Manual gas shut-off valve
- 18' control wire
- 6" B-vent collar
- Mesh
- Battery backup
- Remotes w/ thermostat function only approved for use in a bedroom or bed sitting room in Canada



No additional items required to complete.

		Disc. Code	MSRP USD	004 IA	010 PA	014 CA	016 NC	EXP
RBV4236IT	Reveal 36 36" Open Hearth B-Vent Gas Fireplace radiant unit with IntelliFire (NG) with traditional brick refractory	HTI 1	\$ 2,219	Y	14	14	Y	N

Conversion Kit

Conversion Kit

DCKP-RBV	LP gas conversion kit for IntelliFire	HTI 1	\$ 99	Y	14	14	Y	Y
----------	---------------------------------------	-------	-------	---	----	----	---	---

Glass Doors - Operable

Glass Bi-Fold Door

DM1036	Original bi-fold glass doors with black trim	HTI 1	\$ 519	Y	Y	Y	Y	Y
DM1036S	Original bi-fold glass doors with stainless steel trim	HTI 1	\$ 569	8	21	14	14	Y



Glass Bi-Fold Door

Control, remotes, wall switches

Smart Stat Remote Control

SMART-STAT-HHT	Remote Control - IPI or SP (on/off, temp readout, thermostat mode, timer mode)	HTI 1	\$ 289	Y	Y	Y	Y	Y
----------------	--------------------------------------------------------------------------------	-------	--------	---	---	---	---	---

Wall Switch

WSK-21-W	Wall switch kit- White (includes 20 ft of wire)	HTI 1	\$ 40	Y	Y	Y	Y	Y
----------	-------------------------------------------------	-------	-------	---	---	---	---	---

Venting

Insulated Flex Duct - Chimney Air Kits/Flex Duct

ID4	4" (100mm) insulated flex duct for outside air - includes two 42" (1065mm) sections	HTI 1	\$ 82	Y	Y	14	Y	Y
-----	-------------------------------------------------------------------------------------	-------	-------	---	---	----	---	---

Uninsulated Flex Duct - Chimney Air Kits/Flex Duct

UD4	4" (100mm) uninsulated flex duct for outside air - includes two 42" (1065mm) sections	HTI 1	\$	53	Y	Y	Y	Y	Y
-----	---------------------------------------------------------------------------------------	-------	----	----	---	---	---	---	---

Adaptor

DG3	Thermal damper	HTI 1	\$	350	Y	21	14	14	Y
-----	----------------	-------	----	-----	---	----	----	----	---

Venting Notes

Requires 6" B-vent pipe. See venting section.

Reveal 42

Includes:

- 43,000 Btu/Hour Input (NG)
- Glowing embers, lava rock, vermiculite
- 6 ceramic fiber logs
- Black hood
- Mesh
- Junction box
- Gas flex connector
- Manual gas shut-off valve
- 18' control wire
- 6" B-vent collar
- Outside air kit
- Battery backup
- Traditional Refractory
- Remotes w/ thermostat function only approved for use in a bedroom or bed sitting room in Canada



No additional items required to complete.

		Disc. Code	MSRP USD	004 IA	010 PA	014 CA	016 NC	EXP
RBV4842IT	Reveal 42 42" Open Hearth B-Vent Gas Fireplace radiant unit with IntelliFire (NG) with traditional brick refractory	HTI 1	\$ 2,589	Y	14	14	Y	N

Conversion Kit

Conversion Kit

DCKP-RBV	LP gas conversion kit for IntelliFire	HTI 1	\$ 99	Y	14	14	Y	Y
----------	---------------------------------------	-------	-------	---	----	----	---	---

Glass Doors - Operable

Glass Bi-Fold Door

DM1042	Original bi-fold glass doors with black trim	HTI 1	\$ 649	Y	Y	Y	Y	Y
DM1042S	Original bi-fold glass doors with stainless steel trim	HTI 1	\$ 699	8	21	14	14	Y



Glass Bi-Fold Door

Control, remotes, wall switches

Smart Stat Remote Control

SMART-STAT-HHT	Remote Control - IPI or SP (on/off, temp readout, thermostat mode, timer mode)	HTI 1	\$ 289	Y	Y	Y	Y	Y
----------------	--------------------------------------------------------------------------------	-------	--------	---	---	---	---	---

Wall Switch

WSK-21-W	Wall switch kit- White (includes 20 ft of wire)	HTI 1	\$ 40	Y	Y	Y	Y	Y
----------	-------------------------------------------------	-------	-------	---	---	---	---	---

Venting

Insulated Flex Duct - Chimney Air Kits/Flex Duct

ID4	4" (100mm) insulated flex duct for outside air - includes two 42" (1065mm) sections	HTI 1	\$ 82	Y	Y	14	Y	Y
-----	-------------------------------------------------------------------------------------	-------	-------	---	---	----	---	---

Uninsulated Flex Duct - Chimney Air Kits/Flex Duct

UD4	4" (100mm) uninsulated flex duct for outside air - includes two 42" (1065mm) sections	HTI 1	\$	53	Y	Y	Y	Y	Y
-----	---------------------------------------------------------------------------------------	-------	----	----	---	---	---	---	---

Adaptor

DG3	Thermal damper	HTI 1	\$	350	Y	21	14	14	Y
-----	----------------	-------	----	-----	---	----	----	----	---

Venting Notes

Requires 6" B-vent pipe. See venting section

Hearth & Home Technologies

Fireplace - Gas - Multi-Sided

Stocked Item/Lead Time

004=Mt. Pleasant RDC
010=Kutztown RDC
014=Sacramento RDC
016=Charlotte RDC

EXP=Factory Expedite Program

Prices in USD

Page printed 2/1/2024 3:05:35 PM CST

Future pricing effective for shipments on or after 03/31/2024

* Please Contact Who You Purchase This Through for MSRP Pricing

Non-stock and custom product cannot be cancelled.

Customer is responsible for freight for orders made outside of assigned RDC facility.

Corner Gas Fireplace L/R-COR

Includes:

- 38,000 - 21,000 BTU/Hour input (NG)
- Intellifire touch ignition system
- 7 ceramic fiber logs
- Glowing embers, lava rock
- Tempered glass
- Fiber brick refractory
- 12' control wire
- Junction box
- Battery backup
- Gas flex connector
- Manual gas shut off valve



Required to Complete - Sold Separately: • Front (x1) • End panel (x1)

		Disc. Code	MSRP USD	004 IA	010 PA	014 CA	016 NC	EXP
RCOR-DV36IN	36" Right Corner Direct Vent Multi Side Top/Rear Gas Fireplace with Intellifire Touch Ignition (NG)	HTI 1	\$ 4,179	14	14	14	14	N
LCOR-DV36IN	36" Left Corner Direct Vent Multi Side Top/Rear Gas Fireplace with Intellifire Touch Ignition (NG)	HTI 1	\$ 4,179	Y	14	14	14	N

Fronts - Non-Operable (Required to Complete)

Corner End Panel

COREP-36BK	Corner end panel Firescreen front - Black	HTI 1	\$ 369	Y	Y	Y	14	Y
------------	-------------------------------------------	-------	--------	---	---	---	----	---

Corner Firescreen

COR-36BK	Corner Firescreen front - Black	HTI 1	\$ 289	Y	Y	Y	14	N
----------	---------------------------------	-------	--------	---	---	---	----	---



Corner End Panel



Corner Firescreen

Conversion Kit

Conversion Kit

LPK-MS36-IFT	NG to LP conversion kit 36" multi side units	HTI 1	\$ 99	Y	Y	Y	Y	Y
--------------	----------------------------------------------	-------	-------	---	---	---	---	---

Fans						
Fan						
GFK-160C	Fan kit 160 CFM (fan only)	HTI 1	\$	259	Y	Y
GFK-160A	Fan kit 160 CFM (includes rheostat and temperature sensor)	HTI 1	\$	319	Y	Y
Control, remotes, wall switches						
IntelliFire app						
IFT-WFM	IntelliFire Wi-Fi Module that works with the IntelliFire iOS and Android app. Use to control all the features of your fireplace via a smart device. An RC400, RC450 or RC150 is required for thermostat control	HTI 1	\$	219	Y	Y
IntelliFire Touch Controls - Aux Module						
IFT-ACM	IntelliFire Touch AUX Module. Must order if adding Fan, Lights or Power Vent and want to use the IFT-WFM. Do not need to order if using IFT-RC400 (includes IFT-ACM).	HTI 1	\$	96	14	Y
Remote/Wall Switch/Wall Thermostat						
IFT-RC150	IntelliFire Touch white wireless wall switch (on/off, cold climate, battery strength indicator)	HTI 1	\$	116	Y	14
Touch Screen Remote						
IFT-RC400	IntelliFire Touch black remote control, docking station and auxiliary control module (on/off, flame height, thermostat mode, fan control, child lock, cold climate, timer mode, hot indicator, lights, on-screen maintenance and troubleshooting notifications)	HTI 1	\$	379	Y	Y
Wall Switch						
IFT-RC150-HNG	IntelliFire Touch white wireless wall switch (on/off, cold climate, battery strength indicator)	HNG 1	\$	116	Y	Y
IFT-RC150-HTL	IntelliFire Touch white wireless wall switch (on/off, cold climate, battery strength indicator)	HTL 1	\$	116	Y	14



IntelliFire app



Touch Screen Remote



Wall Switch

Venting Notes
Requires DVP venting. See venting section of install manual.
Approved for SLP venting. See venting section of install manual.
Approved for use with PVLP-SLP, PVI-SLP-B and PVV-SLP with power vent wire harness (order separately) and IFT-RC400 remote. See venting section of manual.

Pier 36

Includes:

- 38,000 - 21,000 BTU/Hour input (NG)
- 6 ceramic fiber logs
- Glowing embers, lava rock
- Tempered glass
- Black steel refractory
- 12' control wire
- Junction box
- Battery backup
- IntelliFire Touch ignition system
- Gas flex connector
- Manual gas shut off valve
- Crushed glass and stone media require the purchase of the STPR-MOD-KIT



Required to Complete - Sold Separately: • Fronts (x2) • End panel (x1)

		Disc. Code	MSRP USD	004 IA	010 PA	014 CA	016 NC	EXP
PIER-DV36IN	36" Pier Direct Vent Multi Side Top/Rear Gas Fireplace With IntelliFire Touch ignition (NG)	HTI 1	\$ 4,519	Y	14	14	14	N

Fronts - Non-Operable (Required to Complete)

Multi Side Front

MSFR-36-BK	Multi Side Firescreen Front - Black	HTI 1	\$ 339	Y	Y	Y	Y	Y
------------	-------------------------------------	-------	--------	---	---	---	---	---



Multi Side Front

End Panels (Required to Complete)

Multi Side Front End Panel

MSEP-36-BK	Multi Side End Panel Firescreen Front - Black	HTI 1	\$ 369	Y	14	14	14	Y
------------	-----------------------------------------------	-------	--------	---	----	----	----	---

Conversion Kit

Conversion Kit

LPK-MS36-IFT	NG to LP conversion kit 36" multi side units	HTI 1	\$ 99	Y	Y	Y	Y	Y
STPR-MOD-KIT	Contemporary conversion kit for See Through and Peninsula units (must order media to complete) (for use with standard black metal refractory or Black glass interior panels only)	HTI 1	\$ 599	14	21	14	14	Y

Media										
Crushed Glass Media										
MEDIA-CLEAR-MS	Glass media, Crystal (translucent white) (must order STPR-MOD-KIT to complete)	HTI 1	\$ 199	14	21	14	14	Y		
MEDIA-RED-MS	Glass media, Scarlet (red) (must order STPR-MOD-KIT to complete)	HTI 1	\$ 249	14	21	14	14	Y		
MEDIA-FOG-MS	Iced fog media (requires black spray paint to complete) (must order STPR-MOD-KIT to complete)	HTI 1	\$ 249	14	21	14	14	Y		
MEDIA-EBONY-MS	Glass media, Ebony (black) (must order STPR-MOD-KIT to complete)	HTI 1	\$ 249	14	21	14	14	Y		
MEDIA-COBALT-MS	Glass media, Cobalt (blue) (must order STPR-MOD-KIT to complete)	HTI 1	\$ 249	14	21	14	14	Y		
MEDIA-AMBER-MS	Glass media, (Amber) (must order STPR-MOD-KIT to complete)	HTI 1	\$ 249	14	21	14	14	Y		
Stone Media										
MEDIA-STONES-30	Large, multi-colored fiber stone media	HTI 1	\$ 209	14	21	14	14	Y		
Liner Kit										
Liner Kit										
LINER-36PIER	Reflective Black glass interior panels for Peninsula	HTI 1	\$ 569	14	21	14	14	Y		
Refractory Upgrade										
Brick Refractory										
WTB36-PR	Traditional brick interior liner 36" Peninsula - Weathered Traditional Brick	HTI 1	\$ 299	77	84	84	84	Y		
Fans										
Fan										
GFK-160C	Fan kit 160 CFM (fan only)	HTI 1	\$ 259	Y	Y	Y	Y	Y		
GFK-160A	Fan kit 160 CFM (includes rheostat and temperature sensor)	HTI 1	\$ 319	Y	Y	Y	Y	Y		
Control, remotes, wall switches										
Battery Back Up										
BATTERY-WSK	Battery backup wall switch kit for units with IFT control systems. Includes: On/Off Wall Switch, USB-C Port, Battery Backup, Cover Plate, 12' Wire Harness	HTI 1	\$ 179	Y	14	14	14	Y		
IntelliFire app										
IFT-WFM	IntelliFire Wi-Fi Module that works with the IntelliFire iOS and Android app. Use to control all the features of your fireplace via a smart device. An RC400, RC450 or RC150 is required for thermostat control	HTI 1	\$ 219	Y	Y	Y	Y	Y		
IntelliFire Touch Controls - Aux Module										
IFT-ACM	IntelliFire Touch AUX Module. Must order if adding Fan, Lights or Power Vent and want to use the IFT-WFM. Do not need to order if using IFT-RC400 (includes IFT-ACM).	HTI 1	\$ 96	14	Y	14	14	Y		
Remote/Wall Switch/Wall Thermostat										
IFT-RC150	IntelliFire Touch white wireless wall switch (on/off, cold climate, battery strength indicator)	HTI 1	\$ 116	Y	14	14	Y	Y		
Touch Screen Remote										
IFT-RC400	IntelliFire Touch black remote control, docking station and auxiliary control module (on/off, flame height, thermostat mode, fan control, child lock, cold climate, timer mode, hot indicator, lights, on-screen maintenance and troubleshooting notifications)	HTI 1	\$ 379	Y	Y	Y	Y	Y		

Wall Switch					
IFT-RC150-HNG	IntelliFire Touch white wireless wall switch (on/off, cold climate, battery strength indicator)	HNG 1	\$	116	Y Y Y Y Y
IFT-RC150-HTL	IntelliFire Touch white wireless wall switch (on/off, cold climate, battery strength indicator)	HTL 1	\$	116	Y 14 14 Y Y



Battery Back Up



IntelliFire app

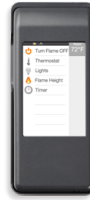

Touch Screen Remote



Wall Switch

Venting Notes
Requires DVP venting. See venting section of install manual.
Approved for SLP venting. See venting section of install manual.
Approved for use with PVLP-SLP, PVI-SLP-B and PVV-SLP with power vent wire harness (order separately) and IFT-RC400 remote. See venting section of manual.

See Through 36

Includes:

- 38,000 - 21,000 BTU/Hour input (NG)
- 6 ceramic fiber logs
- Glowing embers, lava rock
- Tempered glass
- Black steel refractory
- 12' control wire
- Junction box
- Battery backup
- IntelliFire Touch ignition system
- Gas flex connector
- Manual gas shut off valve
- Crushed glass and stone media require the purchase of the STPR-MOD-KIT



Required to Complete - Sold Separately: • Fronts (x2)

		Disc. Code	MSRP USD	004 IA	010 PA	014 CA	016 NC	EXP
ST-DV36IN	36" See Through Direct Vent Multi Side Top/Rear Gas Fireplace With IntelliFire Touch Ignition (NG)	HTI 1	\$ 4,599	Y	Y	Y	Y	N

Fronts - Non-Operable (Required to Complete)

Multi Side Front

MSFR-36-BK	Multi Side Firescreen Front - Black	HTI 1	\$ 339	Y	Y	Y	Y	Y
------------	-------------------------------------	-------	--------	---	---	---	---	---



Multi Side Front

Conversion Kit

Conversion Kit

LPK-MS36-IFT	NG to LP conversion kit 36" multi side units	HTI 1	\$ 99	Y	Y	Y	Y	Y
STPR-MOD-KIT	Contemporary conversion kit for See Through and Peninsula units (must order media to complete) (for use with standard black metal refractory or Black glass interior panels only)	HTI 1	\$ 599	14	21	14	14	Y

Media

Crushed Glass Media

MEDIA-CLEAR-MS	Glass media, Crystal (translucent white) (must order STPR-MOD-KIT to complete)	HTI 1	\$ 199	14	21	14	14	Y
MEDIA-EBONY-MS	Glass media, Ebony (black) (must order STPR-MOD-KIT to complete)	HTI 1	\$ 249	14	21	14	14	Y
MEDIA-RED-MS	Glass media, Scarlet (red) (must order STPR-MOD-KIT to complete)	HTI 1	\$ 249	14	21	14	14	Y
MEDIA-FOG-MS	Iced fog media (requires black spray paint to complete) (must order STPR-MOD-KIT to complete)	HTI 1	\$ 249	14	21	14	14	Y
MEDIA-AMBER-MS	Glass media, (Amber) (must order STPR-MOD-KIT to complete)	HTI 1	\$ 249	14	21	14	14	Y
MEDIA-COBALT-MS	Glass media, Cobalt (blue) (must order STPR-MOD-KIT to complete)	HTI 1	\$ 249	14	21	14	14	Y

Stone Media										
MEDIA-STONES-30	Large, multi-colored fiber stone media	HTI 1	\$ 209	14	21	14	14	Y		
Liner Kit										
Liner Kit										
LINER-36ST	Reflective Black glass interior panels for See-Through	HTI 1	\$ 639	14	21	14	14	Y		
Refractory Upgrade										
Brick Refractory										
WTB36-ST	Traditional brick interior liner 36" See Through - Weathered Traditional Brick	HTI 1	\$ 389	Y	84	84	84	Y		
Fans										
Fan										
GFK-160C	Fan kit 160 CFM (fan only)	HTI 1	\$ 259	Y	Y	Y	Y	Y		
GFK-160A	Fan kit 160 CFM (includes rheostat and temperature sensor)	HTI 1	\$ 319	Y	Y	Y	Y	Y		
Control, remotes, wall switches										
Battery Back Up										
BATTERY-WSK	Battery backup wall switch kit for units with IFT control systems. Includes: On/Off Wall Switch, USB-C Port, Battery Backup, Cover Plate, 12' Wire Harness	HTI 1	\$ 179	Y	14	14	14	Y		
IntelliFire app										
IFT-WFM	IntelliFire Wi-Fi Module that works with the IntelliFire iOS and Android app. Use to control all the features of your fireplace via a smart device. An RC400, RC450 or RC150 is required for thermostat control	HTI 1	\$ 219	Y	Y	Y	Y	Y		
IntelliFire Touch Controls - Aux Module										
IFT-ACM	IntelliFire Touch AUX Module. Must order if adding Fan, Lights or Power Vent and want to use the IFT-WFM. Do not need to order if using IFT-RC400 (includes IFT-ACM).	HTI 1	\$ 96	14	Y	14	14	Y		
Remote/Wall Switch/Wall Thermostat										
IFT-RC150	IntelliFire Touch white wireless wall switch (on/off, cold climate, battery strength indicator)	HTI 1	\$ 116	Y	14	14	Y	Y		
Touch Screen Remote										
IFT-RC400	IntelliFire Touch black remote control, docking station and auxiliary control module (on/off, flame height, thermostat mode, fan control, child lock, cold climate, timer mode, hot indicator, lights, on-screen maintenance and troubleshooting notifications)	HTI 1	\$ 379	Y	Y	Y	Y	Y		
Wall Switch										
IFT-RC150-HNG	IntelliFire Touch white wireless wall switch (on/off, cold climate, battery strength indicator)	HNG 1	\$ 116	Y	Y	Y	Y	Y		
IFT-RC150-HTL	IntelliFire Touch white wireless wall switch (on/off, cold climate, battery strength indicator)	HTL 1	\$ 116	Y	14	14	Y	Y		

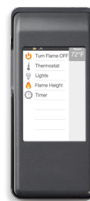

Battery Back Up

IntelliFire app

Touch Screen Remote

Wall Switch

Venting Notes

Requires DVP venting. See venting section of install manual.

Approved for SLP venting. See venting section of install manual.

Approved for use with PVLP-SLP, PVI-SLP-B and PVV-SLP with power vent wire harness (order separately) and IFT-RC400 remote. See venting section of manual.

Hearth & Home Technologies

Fireplace - Wood - Single-Sided

Stocked Item/Lead Time

004=Mt. Pleasant RDC
010=Kutztown RDC
014=Sacramento RDC
016=Charlotte RDC

EXP=Factory Expedite Program

Page printed 2/1/2024 3:05:35 PM CST

Future pricing effective for shipments on or after 03/31/2024

* Please Contact Who You Purchase This Through for MSRP Pricing

Prices in USD

Non-stock and custom product cannot be cancelled.

Customer is responsible for freight for orders made outside of assigned RDC facility.

Pioneer II

Includes:

- 68,200 Peak Btu/Hour Output
- Automatic Combustion Control
- Front and single cast iron arched door
- Dual fans with speed control
- Welded steel firebox
- CAK4A
- Outside air hood
- Attic insulation shield
- 2.7 cu/ft firebox
- Certified to 2020 EPA emissions standards



Required to Complete - Sold Separately: • Advanced Technology Product training required before product ships

		Disc. Code	MSRP USD	004 IA	010 PA	014 CA	016 NC	EXP
PIONEER-II-C	Wood fireplace, with classic black front and single arch door	HTI 3	\$ 6,199	Y	Y	Y	Y	N

Options & Accessories

Finishing Template

HHT-TEMPLATE-C	Metal finishing template	HTI 1	\$ 199	Y	21	14	14	Y
----------------	--------------------------	-------	--------	---	----	----	----	---

Lintel Bar

LINTELBAR-HHT	Lintel bar	HTI 1	\$ 349	8	21	14	14	Y
---------------	------------	-------	--------	---	----	----	----	---

Heat Management

Heat Zone Kit

HEAT-ZONE-WD-C	Heat distribution kit (includes fan, grille cover, fireplace adaptor, and adjustment control) requires 6" vent for ducting	HTI 1	\$ 389	Y	Y	Y	Y	Y
----------------	----------------------------------------------------------------------------------------------------------------------------	-------	--------	---	---	---	---	---

Floor Protector (HP)

Micore Hearth Extension - Hearth Extension

HX4M	Hearth extension for 42" models (70"x 20"x 1/2") - pack of 5	HTI 1	\$ 329	Y	Y	Y	Y	N
------	--------------------------------------------------------------	-------	--------	---	---	---	---	---

Venting

Outside Air Kit

OA-RD-6	Outside air elbow kit (used to offset outside air starting collar)	HTI 1	\$ 59	Y	21	14	14	Y
---------	--------------------------------------------------------------------	-------	-------	---	----	----	----	---

Venting Notes

Requires SL300 or 8" DuraPlus pipe with the DuraPlus base plate. See venting section

When using 8" DuraPlus use DV-6DP-IS attic insulation shield

Pioneer III

Includes:

- 90,900 Peak Btu/Hour Output
- Smart Burn Technology
- 7-day programmable wired wall thermostat
- Single cast iron door
- 400 CFM fan system
- Fan air kit grill
- Welded steel firebox
- CAK4A
- Outside air hood
- Attic insulation shield
- 4.1 cu/ft firebox
- Certified to 2020 EPA emissions standards



Required to Complete - Sold Separately: • Front • Advanced Technology Product training required before product ships

		Disc. Code	MSRP USD	004 IA	010 PA	014 CA	016 NC	EXP
PIONEER-III-ABK	Wood Fireplace with Arch door, classic black	HTI 3	\$ 5,849	Y	Y	Y	14	N
PIONEER-III-RBK	Wood Fireplace with Rectangular door, classic black	HTI 3	\$ 5,849	Y	Y	Y	14	N

Fronts - Non-Operable (Required to Complete)

Forged Arch Face

DF-PIII-FA	Forged arch front, classic black	HTI 3	\$ 1,369	Y	Y	Y	28	N
------------	----------------------------------	-------	----------	---	---	---	----	---

Mission Arch Face

DF-PIII-MA	Mission arch front, classic black	HTI 3	\$ 749	Y	Y	Y	21	N
------------	-----------------------------------	-------	--------	---	---	---	----	---

Mission Rectangular Face

DF-PIII-MR	Mission rectangular front, classic black	HTI 3	\$ 749	Y	Y	Y	14	N
------------	------------------------------------------	-------	--------	---	---	---	----	---



Forged Arch Face



Mission Arch Face



Mission Rectangular Face

Options & Accessories

Finishing Template

TMP-PIIIA	Reusable metal finishing template for the Pioneer III-ABK	HTI 3	\$ 279	8	21	14	14	N
TMP-PIIIR	Reusable metal finishing template for the Pioneer III-RBK	HTI 3	\$ 279	8	21	14	14	N

Heat Management

Heat Zone Kit

HEAT-ZONE-WD-C	Heat distribution kit (includes fan, grille cover, fireplace adaptor, and adjustment control) requires 6" vent for ducting	HTI 1	\$ 389	Y	Y	Y	Y	Y
----------------	----------------------------------------------------------------------------------------------------------------------------	-------	--------	---	---	---	---	---

Floor Protector (HP)

Micore Hearth Extension - Hearth Extension

HX4M	Hearth extension for 42" models (70"x 20"x 1/2") - pack of 5	HTI 1	\$	329	Y	Y	Y	Y	N
------	--------------------------------------------------------------	-------	----	-----	---	---	---	---	---

Service Parts

Service Parts

LINTELBAR-PIII	LINTEL BAR	HTI 1	\$	349	8	21	14	14	Y
----------------	------------	-------	----	-----	---	----	----	----	---

Venting Notes

Requires SL300 or 8" DuraPlus pipe with the DuraPlus base plate. See venting section

When using 8" DuraPlus use DV-6DP-IS attic insulation shield

Hearth & Home Technologies

Fireplace Outdoor - Gas - Single-Sided

Stocked Item/Lead Time

004=Mt. Pleasant RDC
010=Kutztown RDC
014=Sacramento RDC
016=Charlotte RDC

EXP=Factory Expedite Program

Prices in USD

Page printed 2/1/2024 3:05:35 PM CST

Future pricing effective for shipments on or after 03/31/2024

* Please Contact Who You Purchase This Through for MSRP Pricing

Non-stock and custom product cannot be cancelled.

Customer is responsible for freight for orders made outside of assigned RDC facility.

Courtyard 36

Includes:

- Clean face & flush hearth design
- Stainless steel pull screens
- Wall switch with outdoor control box
- 55,000 BTUs
- 36" X 30" viewing area
- UL/ULC Listed



Required to Complete - Sold Separately:

- Hearth Kit (GR-ODCOUG) & choice of log set (SD/HDLOGS-ODCOUG)
- Choice of refractory required for ODCOUG-36NR
- Units are built NG. Conversion kit required for LP.

		Disc. Code	MSRP USD	004 IA	010 PA	014 CA	016 NC	EXP
ODCOUG-36NR	36" Courtyard Outdoor Fireplace, refractory required	HTI 3	\$ 2,469	Y	Y	Y	Y	N
ODCOUG-36TS	36" Courtyard Outdoor Fireplace, Traditional Stacked Concrete Refractory	HTI 3	\$ 2,839	Y	Y	Y	Y	N

Hearth Kit (Required to Complete)

Hearth Kit

GR-ODCOUG	Stainless steel grate with lava rock	HTI 3	\$ 359	Y	Y	Y	Y	Y
-----------	--------------------------------------	-------	--------	---	---	---	---	---

Gas Logs - Log Set Option (Required to Complete)

Log Set - Traditional

SDLOGS-ODCOUG	Standard definition log set, requires GR-ODCOUG to complete	HTI 3	\$ 419	Y	Y	Y	Y	Y
HDLOGS-ODCOUG	High definition log set, requires GR-ODCOUG to complete	HTI 3	\$ 789	Y	Y	Y	Y	Y

Refractory (Required to Complete)

Courtyard Refractory for -NR Units

ODCOUG-36SSL	36" Courtyard Outdoor Fireplace, Stainless Steel Refractory	HTI 3	\$ 469	Y	Y	Y	Y	Y
ODCOUG-36GTR	36" Courtyard Outdoor Fireplace, Gray Traditional Refractory	HTI 3	\$ 479	Y	Y	Y	Y	Y
ODCOUG-36BTR	36" Courtyard Outdoor Fireplace, Brown Traditional Refractory	HTI 3	\$ 479	Y	14	Y	Y	Y
ODCOUG-36BHR	36" Courtyard Outdoor Fireplace, Brown Herringbone Refractory	HTI 3	\$ 549	Y	Y	Y	Y	Y
ODCOUG-36GHR	36" Courtyard Outdoor Fireplace, Gray Herringbone Refractory	HTI 3	\$ 549	Y	Y	Y	Y	Y

LP Conversion Kit

Courtyard Conversion Kits

ODCOUG-LPK	LP conversion kit for the Courtyard fireplace	HTI 3	\$ 99	Y	Y	Y	Y	Y
ODCOUG-NGK	NG conversion kit for the Courtyard fireplace	HTI 3	\$ 99	8	14	14	14	Y

Firescreens

Courtyard Screen

ODCOUG-36SCN	Framed mesh hang-on screen for Courtyard 36"	HTI 3	\$	589	Y	Y	Y	Y	Y
--------------	----------------------------------------------	-------	----	-----	---	---	---	---	---

Options & Accessories

Outdoor Gas Drain Pan

ODGSDPFLT-36	36" Outdoor Drain Pan for rubber roof installs	HTI 3	\$	103	8	14	14	14	Y
ODGSDP-36	36" Outdoor Drain Pan	HTI 3	\$	103	Y	14	14	Y	Y

Outdoor Vent Free Pan

ODCOUG-VFP	Vent Free pan for the Courtyard Outdoor Fireplace	HTI 3	\$	128	Y	Y	Y	Y	Y
------------	---------------------------------------------------	-------	----	-----	---	---	---	---	---

Control, remotes, wall switches

Wired Wall Timer

WWT	Wired wall timer (30, 60, 120 minutes)	HTI 3	\$	118	Y	Y	Y	Y	Y
-----	----------------------------------------	-------	----	-----	---	---	---	---	---

Venting Notes

No venting is required with this unit

Courtyard 42

Includes:

- Clean face & flush hearth design
- Wall switch with outdoor control box
- Stainless steel pull screens
- 55,000 BTUs
- 42" X 30" viewing area
- UL/ULC Listed



Required to Complete - Sold Separately:

- Hearth Kit (GR-ODCOUG) & choice of log set (SD/HDLOGS-ODCOUG)
- Choice of refractory required for ODCOUG-42NR
- Units are built NG. Conversion kit required for LP.

		Disc. Code	MSRP USD	004 IA	010 PA	014 CA	016 NC	EXP
ODCOUG-42NR	42" Courtyard Outdoor Fireplace, refractory required	HTI 3	\$ 2,779	Y	Y	Y	Y	N
ODCOUG-42TS	42" Courtyard Outdoor Fireplace, Traditional Stacked Concrete Refractory	HTI 3	\$ 3,149	Y	Y	Y	Y	N

Hearth Kit (Required to Complete)

Hearth Kit

GR-ODCOUG	Stainless steel grate with lava rock	HTI 3	\$ 359	Y	Y	Y	Y	Y
-----------	--------------------------------------	-------	--------	---	---	---	---	---

Gas Logs - Log Set Option (Required to Complete)

Log Set - Traditional

SDLOGS-ODCOUG	Standard definition log set, requires GR-ODCOUG to complete	HTI 3	\$ 419	Y	Y	Y	Y	Y
HDLOGS-ODCOUG	High definition log set, requires GR-ODCOUG to complete	HTI 3	\$ 789	Y	Y	Y	Y	Y

Refractory (Required to Complete)

Courtyard Refractory for -NR Units

ODCOUG-42SSL	42" Courtyard Outdoor Fireplace, Stainless Steel Refractory	HTI 3	\$ 479	8	14	14	14	Y
ODCOUG-42GTR	42" Courtyard Outdoor Fireplace, Gray Traditional Refractory	HTI 3	\$ 509	Y	Y	Y	Y	Y
ODCOUG-42BTR	42" Courtyard Outdoor Fireplace, Brown Traditional Refractory	HTI 3	\$ 509	Y	Y	Y	Y	Y
ODCOUG-42GHR	42" Courtyard Outdoor Fireplace, Gray Herringbone Refractory	HTI 3	\$ 579	Y	Y	Y	Y	Y
ODCOUG-42BHR	42" Courtyard Outdoor Fireplace, Brown Herringbone Refractory	HTI 3	\$ 579	Y	Y	Y	Y	Y

LP Conversion Kit

Courtyard Conversion Kits

ODCOUG-LPK	LP conversion kit for the Courtyard fireplace	HTI 3	\$ 99	Y	Y	Y	Y	Y
ODCOUG-NGK	NG conversion kit for the Courtyard fireplace	HTI 3	\$ 99	8	14	14	14	Y

Firescreens

Courtyard Screen

ODCOUG-42SCN	Framed mesh hang-on screen for Courtyard 42"	HTI 3	\$ 689	Y	Y	Y	Y	Y
--------------	----------------------------------------------	-------	--------	---	---	---	---	---

Options & Accessories

Outdoor Gas Drain Pan

ODGSDP-42	42" Outdoor Drain Pan	HTI 3	\$ 118	8	14	14	14	Y
ODGSDPFLT-42	42" Outdoor Drain Pan for rubber roof installs	HTI 3	\$ 118	8	14	14	14	Y

Outdoor Vent Free Pan

ODCOUG-VFP	Vent Free pan for the Courtyard Outdoor Fireplace	HTI 3	\$ 128	Y	Y	Y	Y	Y
------------	---------------------------------------------------	-------	--------	---	---	---	---	---

Control, remotes, wall switches

Wired Wall Timer

WWT	Wired wall timer (30, 60, 120 minutes)	HTI 3	\$	118	Y	Y	Y	Y	Y
-----	----------------------------------------	-------	----	-----	---	---	---	---	---

Venting Notes

No venting is required with this unit

Lanai 48

Includes:

- Multicolored LED lights
- Crystal glass media
- Glass wind guard
- Wall control with 15' of wire and junction box
- Gas flex connector
- 55,000 BTUs
- 48" x 17" viewing area
- UL/ULC listed



Required to Complete - Sold Separately: • Units are built NG. Conversion kit required for LP.

		Disc. Code	MSRP USD	004 IA	010 PA	014 CA	016 NC	EXP
ODLANAIG-48	48" Lanai outdoor linear fireplace with IntelliFire Ignition, Single-sided	HTI 3	\$ 4,269	Y	Y	Y	Y	N

Conversion Kit

Conversion Kit

LPK-ODLANAIG48	LP Conversion Kit - 48" Lanai	HTI 3	\$ 129	Y	Y	Y	Y	Y
----------------	-------------------------------	-------	--------	---	---	---	---	---

Firescreens

Lanai Screen

ODLANAIG-48SCN	Framed Screen Barrier - 48" Lanai	HTI 3	\$ 399	Y	Y	Y	Y	Y
----------------	-----------------------------------	-------	--------	---	---	---	---	---



Lanai Screen

Clean Face Kit

Lanai CF Kit

ODLANAIG-48CFT	Clean Face Trim Kit - 48" Lanai	HTI 3	\$ 269	Y	14	14	14	Y
----------------	---------------------------------	-------	--------	---	----	----	----	---

Gas Logs - Log Set Option

Log Accessories

CDLS	Driftwood Log Set	HTI 1	\$ 569	Y	Y	14	Y	Y
------	-------------------	-------	--------	---	---	----	---	---

Media

Crushed Glass Media

MEDIA-CLEAR-48	Glass media, crystal (translucent white)	HTI 1	\$ 249	Y	Y	Y	Y	Y
MEDIA-RED-48	Glass media, scarlet (red)	HTI 1	\$ 359	14	21	14	14	Y
MEDIA-AMBER-48	Glass media, amber	HTI 1	\$ 359	Y	Y	Y	Y	Y
MEDIA-COBALT-48	Glass media, cobalt (blue)	HTI 1	\$ 359	Y	21	Y	14	Y
MEDIA-EBONY-48	Glass media, ebony (black)	HTI 1	\$ 359	Y	Y	Y	Y	Y

MEDIA

STONEKIT	Stone Kit	HTI 1	\$	146	Y	Y	Y	Y	Y
----------	-----------	-------	----	-----	---	---	---	---	---

Options & Accessories

Options & Accessories

ODLANAIG-48DP	Drain Pan - 48" Lanai	HTI 3	\$	219	Y	14	14	14	Y
---------------	-----------------------	-------	----	-----	---	----	----	----	---

Venting Notes

No venting is required with this unit.

Lanai 60

Includes:

- Multicolored LED lights
- Crystal glass media
- Glass wind guard
- Wall control with 14' of wire and junction box
- Gas flex connector
- 65,000 BTUs
- 60" x 17" viewing area
- UL/ULC listed



Required to Complete - Sold Separately: • Units are built NG. Conversion kit required for LP.

		Disc. Code	MSRP USD	004 IA	010 PA	014 CA	016 NC	EXP
ODLANAIG-60	60" Lanai outdoor linear fireplace with IntelliFire Ignition, Single-sided	HTI 3	\$ 4,599	Y	Y	Y	Y	N

Conversion Kit

Conversion Kit

LPK-ODLANAIG60	LP Conversion Kit - 60" Lanai	HTI 3	\$ 149	Y	Y	Y	Y	Y
----------------	-------------------------------	-------	--------	---	---	---	---	---

Firescreens

Lanai Screen

ODLANAIG-60SCN	Framed Screen Barrier - 60" Lanai	HTI 3	\$ 469	Y	Y	14	21	Y
----------------	-----------------------------------	-------	--------	---	---	----	----	---



Lanai Screen

Clean Face Kit

Lanai CF Kit

ODLANAIG-60CFT	Clean Face Trim Kit - 60" Lanai	HTI 3	\$ 289	Y	21	Y	14	Y
----------------	---------------------------------	-------	--------	---	----	---	----	---

Gas Logs - Log Set Option

Log Accessories

CDLS	Driftwood Log Set	HTI 1	\$ 569	Y	Y	14	Y	Y
------	-------------------	-------	--------	---	---	----	---	---

Media

Crushed Glass Media

MEDIA-CLEAR-48	Glass media, crystal (translucent white)	HTI 1	\$ 249	Y	Y	Y	Y	Y
MEDIA-AMBER-48	Glass media, amber	HTI 1	\$ 359	Y	Y	Y	Y	Y
MEDIA-COBALT-48	Glass media, cobalt (blue)	HTI 1	\$ 359	Y	21	Y	14	Y
MEDIA-EBONY-48	Glass media, ebony (black)	HTI 1	\$ 359	Y	Y	Y	Y	Y
MEDIA-RED-48	Glass media, scarlet (red)	HTI 1	\$ 359	14	21	14	14	Y

MEDIA

STONEKIT	Stone Kit	HTI 1	\$	146	Y	Y	Y	Y	Y
----------	-----------	-------	----	-----	---	---	---	---	---

Options & Accessories

Options & Accessories

ODLANAIG-60DP	Drain Pan - 60" Lanai	HTI 3	\$	239	Y	21	14	14	Y
---------------	-----------------------	-------	----	-----	---	----	----	----	---

Venting Notes

No venting is required with this unit.

Vesper 36

Includes:

- Stainless steel construction
- Optional mesh cabinet style doors
- 38,000 BTUs
- 36" x 27" viewing area
- UL/ULC Listed



Required to Complete - Sold Separately: • Add the Lumonessen outdoor burner LUM-OD-PM (LP) or LUM-OD-NM (NG) • Select a log set: Mezmer logs, Mezmer split logs, or Mountain Oak logs

		Disc. Code	MSRP USD	004 IA	010 PA	014 CA	016 NC	EXP
VOFB36-T	36" Vesper Outdoor Firebox - Traditional Concrete Refractory	HTI 3	\$ 1,239	Y	14	14	Y	N
VOFB36-H	36" Vesper Outdoor Firebox - Herringbone Concrete Refractory	HTI 3	\$ 1,269	Y	14	14	Y	N

Gas Logs - Log Set Option (Required to Complete)

Gas Logs - Burner Option (OD)

LUM-OD-NM	Lumonessen Outdoor Burner: Manual Ignition, NG: 19,000 MIN - 38,000 MAX BTUs	HTI 3	\$ 799	Y	35	Y	Y	Y
LUM-OD-PM	Lumonessen Outdoor Burner: Manual Ignition, LP: 31,000 MIN - 38,000 MAX BTUs	HTI 3	\$ 799	Y	35	35	Y	Y

Mezmer

MZMR-24	24" Mezmer Log Set	HTI 1	\$ 219	Y	Y	Y	Y	Y
MZMR-30	30" Mezmer Log Set	HTI 1	\$ 249	Y	14	14	Y	Y

Mezmer Split

MZMRSP-24	24" Mezmer Split Log Set	HTI 1	\$ 219	Y	Y	14	Y	Y
MZMRSP-30	30" Mezmer Split Log Set	HTI 1	\$ 249	Y	14	14	Y	Y

Mountain Oak

MTNOK-24	24" Mountain Oak Log Set	HTI 1	\$ 219	Y	Y	Y	Y	Y
MTNOK-30	30" Mountain Oak Log Set	HTI 1	\$ 249	Y	21	21	Y	Y



Mezmer



Mezmer Split



Mountain Oak

Mesh Doors - Operable

Mesh Door

VOFBSD-36	36" Vesper Stainless Steel Mesh Cabinet Style Doors	HTI 3	\$ 1,069	Y	14	14	Y	Y
-----------	-----------------------------------------------------	-------	----------	---	----	----	---	---



Mesh Door

Options & Accessories

Outdoor Gas Drain Pan

ODGSDPFLT-36	36" Outdoor Drain Pan for rubber roof installs	HTI 3	\$	103	8	14	14	14	Y
ODGSDP-36	36" Outdoor Drain Pan	HTI 3	\$	103	Y	14	14	Y	Y

Venting Notes

Venting is not required with this unit

Vesper 42

Includes:

- Stainless steel construction
- Optional mesh cabinet style doors
- 38,000 BTUs
- 42" x 27" viewing area
- UL/ULC Listed



Required to Complete - Sold Separately: • Add the Lumonessen outdoor burner LUM-OD-PM (LP) or LUM-OD-NM (NG) • Select a log set: Mezmer logs, Mezmer split logs, or Mountain Oak logs

		Disc. Code	MSRP USD	004 IA	010 PA	014 CA	016 NC	EXP
VOFB42-T	42" Vesper Outdoor Firebox - Traditional Refractory	HTI 3	\$ 1,779	Y	14	Y	Y	N
VOFB42-H	42" Vesper Outdoor Firebox - Herringbone Refractory	HTI 3	\$ 1,789	Y	14	14	14	N

Gas Logs - Log Set Option (Required to Complete)

Gas Logs - Burner Option (OD)

LUM-OD-PM	Lumonessen Outdoor Burner: Manual Ignition, LP: 31,000 MIN - 38,000 MAX BTUs	HTI 3	\$ 799	Y	35	35	Y	Y
LUM-OD-NM	Lumonessen Outdoor Burner: Manual Ignition, NG: 19,000 MIN - 38,000 MAX BTUs	HTI 3	\$ 799	Y	35	Y	Y	Y

Mezmer

MZMR-30	30" Mezmer Log Set	HTI 1	\$ 249	Y	14	14	Y	Y
---------	--------------------	-------	--------	---	----	----	---	---

Mezmer Split

MZMRSP-30	30" Mezmer Split Log Set	HTI 1	\$ 249	Y	14	14	Y	Y
-----------	--------------------------	-------	--------	---	----	----	---	---

Mountain Oak

MTNOK-30	30" Mountain Oak Log Set	HTI 1	\$ 249	Y	21	21	Y	Y
----------	--------------------------	-------	--------	---	----	----	---	---



Mezmer



Mezmer Split



Mountain Oak

Mesh Doors - Operable

Mesh Door

VOFBSD-42	42" Vesper Stainless Steel Mesh Cabinet Style Doors	HTI 3	\$ 1,189	Y	14	14	Y	Y
-----------	-----------------------------------------------------	-------	----------	---	----	----	---	---



Mesh Door

Options & Accessories

Outdoor Gas Drain Pan

ODGSDP-42	42" Outdoor Drain Pan	HTI 3	\$	118	8	14	14	14	Y
ODGSDPFLT-42	42" Outdoor Drain Pan for rubber roof installs	HTI 3	\$	118	8	14	14	14	Y

Venting Notes

No venting is required with this unit

Hearth & Home Technologies

Fireplace Outdoor - Wood - Single-Sided

Stocked Item/Lead Time

004=Mt. Pleasant RDC
010=Kutztown RDC
014=Sacramento RDC
016=Charlotte RDC

EXP=Factory Expedite Program

Prices in USD

Page printed 2/1/2024 3:05:35 PM CST

Future pricing effective for shipments on or after 03/31/2024

* Please Contact Who You Purchase This Through for MSRP Pricing

Non-stock and custom product cannot be cancelled.

Customer is responsible for freight for orders made outside of assigned RDC facility.

Castlewood 42

Includes:

- Expansive 38" high firebox opening
- Stainless steel mesh curtain screens
- Black grate
- Transition collar
- Dual gas knockouts
- Outside air hoods
- 41-7/8" x 38" viewing area
- UL & ULC listed



Required to Complete - Sold Separately: • Brick interior panels for an authentic masonry look

		Disc.	MSRP	004	010	014	016	EXP
		Code	USD	IA	PA	CA	NC	
ODCASTLEWD-42-B	42" Castlewood Outdoor Wood Firebox	HTI 3	\$ 3,349	Y	Y	Y	Y	N

Brick Panels (Required to Complete)

Castlewood 42-B Refractory

WDRV-42T	42" Wood Traditional Stacked Refractory-Antler Velvet	HTI 3	\$ 1,059	Y	Y	Y	Y	N
WDRV-42H	42" Wood Herringbone Refractory-Antler Velvet	HTI 3	\$ 1,479	Y	Y	Y	Y	N

Glass Doors - Operable

Outdoor Glass Bi-Fold Door

ODGF42BZ-B	Premium outdoor glass bi-fold door with stainless steel construction, bronze finish	HTI 3	\$ 2,489	28	28	28	28	Y
------------	-------------------------------------------------------------------------------------	-------	----------	----	----	----	----	---



Outdoor Glass Bi-Fold Door

Gas Logs - Log Set Option

Fireside Grand Oak Outdoor Gas Log Sets

OGO324-MTCH-HK	24" Match Light Outdoor Grand Oaks Burner/Hearth Kit - 3 Tier (NG only)	HTI 3	\$ 1,499	21	14	28	21	Y
OGO324-IPING-HK	24" IPI Outdoor Grand Oaks NG Burner/Hearth Kit - 3 Tier	HTI 3	\$ 1,689	Y	21	14	21	Y
OGO324-IPILP-HK	24" IPI Outdoor Grand Oaks LP Burner/Hearth Kit - 3 Tier	HTI 3	\$ 1,689	21	21	21	21	Y

Grand Oak Logs 324

GO324	24" Grand Oak Log Set - 11pcs, 3 Tier	HTI 3	\$ 599	Y	14	14	Y	N
-------	---------------------------------------	-------	--------	---	----	----	---	---



Fireside Grand Oak Outdoor Gas Log Sets

Mortar

Refractory Mortar

MMMORTR	10 lbs. Mortar (TRAD: 1 required, HERR: 2 required)	HTI 1	\$ 94	Y	Y	Y	Y	N
---------	-----------------------------------------------------	-------	-------	---	---	---	---	---

Options & Accessories

Outdoor Gas Drain Pan

ODCASTLEWD-42DP	Drain Pan for 42" Castlewood	HTI 3	\$ 209	8	14	14	14	Y
-----------------	------------------------------	-------	--------	---	----	----	----	---

Venting

SL1100 Wood Pipe - Single Pack - Chimney Air Kits/Flex Duct Dimensions: 11" Inner / 13" Outer

CAK8A	Chimney air kit (For use with BIR42 and RUTHERFORD-42, ODCASTLEWD-42)	HTI 1	\$ 145	Y	Y	14	14	Y
-------	------------------------------------------------------------------------	-------	--------	---	---	----	----	---

Venting Notes

- Requires SL1100 series pipe. See Venting section.
- Cooling hood or all non-combustible materials are required.
- Canada: Requires SL400 series pipe, SLA10 and CAK8A. See Venting section.

Cottagewood 36

Includes:

- Mineral Gray Traditional or Herringbone refractory liners
- Dual gas knockouts
- Convenient damper control
- Stainless steel facings
- Stainless steel safety screens
- Outside air kit
- Black grate
- UL/ULC listed
- Viewing area: 36" x 28 1/2"



Required to Complete - Sold Separately: • Flex Duct

		Disc. Code	MSRP USD	004 IA	010 PA	014 CA	016 NC	EXP
ODCTGWD-36	Cottagewood 36" Outdoor Wood-Burning Fireplace with Gray Traditional refractory	HTI 3	\$ 2,969	Y	14	14	14	N
ODCTGWD-36H	Cottagewood 36" Outdoor Wood-Burning Fireplace with Gray Herringbone refractory	HTI 3	\$ 3,009	Y	14	14	14	N

Venting (Required to Complete)

Insulated Flex Duct - Chimney Air Kits/Flex Duct

ID4	4" (100mm) insulated flex duct for outside air - includes two 42" (1065mm) sections	HTI 1	\$ 82	Y	Y	14	Y	Y
-----	-------------------------------------------------------------------------------------	-------	-------	---	---	----	---	---

Uninsulated Flex Duct - Chimney Air Kits/Flex Duct

UD4	4" (100mm) uninsulated flex duct for outside air - includes two 42" (1065mm) sections	HTI 1	\$ 53	Y	Y	Y	Y	Y
-----	---------------------------------------------------------------------------------------	-------	-------	---	---	---	---	---

4" Insulated Flex Duct

FLEXDUCT4AI	4" (102mm) insulated flex duct for outside air - 25'	HTI 1	\$ 75	Y	14	14	21	N
-------------	------------------------------------------------------	-------	-------	---	----	----	----	---

SL400 Series Pipe - Term Kits & Acc - Sng Pk - Chimney Air Kits/Flex Duct

CAK5A	Chimney air kit for SL1100 and SL400 series pipe (required in Canada)	HTI 1	\$ 135	Y	Y	14	14	Y
-------	-----------------------------------------------------------------------	-------	--------	---	---	----	----	---

Doors - Operable

Cottagewood Glass Doors

DM6036-S	36" stainless steel bi-fold doors for the 36" Cottagewood	HTI 3	\$ 499	8	14	14	14	Y
----------	-----------------------------------------------------------	-------	--------	---	----	----	----	---

Gas Logs - Log Set Option

Fireside Grand Oak Outdoor Gas Log Sets

OGO324-MTCH-HK	24" Match Light Outdoor Grand Oaks Burner/Hearth Kit - 3 Tier (NG only)	HTI 3	\$ 1,499	21	14	28	21	Y
OGO324-IPILP-HK	24" IPI Outdoor Grand Oaks LP Burner/Hearth Kit - 3 Tier	HTI 3	\$ 1,689	21	21	21	21	Y
OGO324-IPING-HK	24" IPI Outdoor Grand Oaks NG Burner/Hearth Kit - 3 Tier	HTI 3	\$ 1,689	Y	21	14	21	Y

Fireside Realwood Gas Log Sets

FRW124	24" Fireside Realwood refractory cement log set (order hearth kit separately)	HTI 3	\$ 229	Y	14	Y	Y	N
--------	-------------------------------------------------------------------------------	-------	--------	---	----	---	---	---

Fireside Realwood Outdoor Gas Log Sets

OD-24NG	24" matchlight hearth kit for outdoor fireplaces - 69,000 Btu/Hour Input (NG only)	HTI 3	\$ 1,009	Y	21	21	21	N
ODSP-24LP	24" safety pilot hearth kit for outdoor fireplaces - 61,000 Btu/Hour input LP (Note: Controls are located on the right and may offset the unit in the fireplace. Choose hearth size accordingly. See installation manual for hearth dimensions.)	HTI 3	\$ 1,079	21	21	21	21	N

Grand Oak Logs 324

GO324	24" Grand Oak Log Set - 11pcs, 3 Tier	HTI 3	\$ 599	Y	14	14	Y	N
-------	---------------------------------------	-------	--------	---	----	----	---	---



Fireside Grand Oak Outdoor Gas Log Sets



Fireside Realwood Gas Log Sets



Fireside Realwood Outdoor Gas Log Sets

Miscellaneous

Cottagewood Drain Pans

ODCTGWD-DP36	Drain pan for the 36" Cottagewood	HTI 3	\$ 169	8	14	14	14	Y
--------------	-----------------------------------	-------	--------	---	----	----	----	---

Freestanding Kits

ODCTGWD-FSK36	Extended smoke shelf for use when unit is installed as a freestanding fireplace and the venting is reduced below the required minimum. See install manual for requirements.	HTI 3	\$ 179	8	14	14	14	Y
---------------	-----------------------------------------------------------------------------------------------------------------------------------------------------------------------------	-------	--------	---	----	----	----	---

Venting Notes

Requires SL1100 series chimney. See Venting section.
Extended smoke shield in the ODCTGWD-FSK (36/42) is for freestanding fireplace installs and reduces min vent height to 9.5'. See install manual for all requirements.
Canada uses SL400 series chimney and requires SLA-10 and CAK5A

Cottagewood 42

Includes:

- Mineral Gray Traditional or Herringbone refractory liners
- Dual gas knockouts
- Convenient damper control
- Stainless steel facings
- Stainless steel safety screens
- Outside air kit
- Black grate
- UL/ULC listed
- Viewing area: 42" x 28 1/2"



Required to Complete - Sold Separately: • Flex Duct

		Disc. Code	MSRP USD	004 IA	010 PA	014 CA	016 NC	EXP
ODCTGWD-42	Cottagewood 42" Outdoor Wood-Burning Fireplace with Gray Traditional refractory	HTI 3	\$ 3,059	Y	Y	14	Y	N
ODCTGWD-42H	Cottagewood 42" Outdoor Wood-Burning Fireplace with Gray Herringbone refractory	HTI 3	\$ 3,109	Y	21	14	Y	N

Venting (Required to Complete)

Insulated Flex Duct - Chimney Air Kits/Flex Duct

ID4	4" (100mm) insulated flex duct for outside air - includes two 42" (1065mm) sections	HTI 1	\$ 82	Y	Y	14	Y	Y
-----	-------------------------------------------------------------------------------------	-------	-------	---	---	----	---	---

Uninsulated Flex Duct - Chimney Air Kits/Flex Duct

UD4	4" (100mm) uninsulated flex duct for outside air - includes two 42" (1065mm) sections	HTI 1	\$ 53	Y	Y	Y	Y	Y
-----	---------------------------------------------------------------------------------------	-------	-------	---	---	---	---	---

4" Insulated Flex Duct

FLEXDUCT4AI	4" (102mm) insulated flex duct for outside air - 25'	HTI 1	\$ 75	Y	14	14	21	N
-------------	------------------------------------------------------	-------	-------	---	----	----	----	---

SL400 Series Pipe - Term Kits & Acc - Sng Pk - Chimney Air Kits/Flex Duct

CAK5A	Chimney air kit for SL1100 and SL400 series pipe (required in Canada)	HTI 1	\$ 135	Y	Y	14	14	Y
-------	-----------------------------------------------------------------------	-------	--------	---	---	----	----	---

Doors - Operable

Cottagewood Glass Doors

DM8042-S	42" stainless steel bi-fold doors for the 42" Cottagewood	HTI 3	\$ 629	Y	14	14	14	Y
----------	-----------------------------------------------------------	-------	--------	---	----	----	----	---

Gas Logs - Log Set Option

Fireside Grand Oak Outdoor Gas Log Sets

OGO324-MTCH-HK	24" Match Light Outdoor Grand Oaks Burner/Hearth Kit - 3 Tier (NG only)	HTI 3	\$ 1,499	21	14	28	21	Y
OGO324-IPILP-HK	24" IPI Outdoor Grand Oaks LP Burner/Hearth Kit - 3 Tier	HTI 3	\$ 1,689	21	21	21	21	Y
OGO324-IPING-HK	24" IPI Outdoor Grand Oaks NG Burner/Hearth Kit - 3 Tier	HTI 3	\$ 1,689	Y	21	14	21	Y

Fireside Realwood Outdoor Gas Log Sets

OD-24NG	24" matchlight hearth kit for outdoor fireplaces - 69,000 Btu/Hour Input (NG only)	HTI 3	\$ 1,009	Y	21	21	21	N
ODSP-24LP	24" safety pilot hearth kit for outdoor fireplaces - 61,000 Btu/Hour input LP (Note: Controls are located on the right and may offset the unit in the fireplace. Choose hearth size accordingly. See installation manual for hearth dimensions.)	HTI 3	\$ 1,079	21	21	21	21	N

Grand Oak Logs 324

GO324	24" Grand Oak Log Set - 11pcs, 3 Tier	HTI 3	\$ 599	Y	14	14	Y	N
-------	---------------------------------------	-------	--------	---	----	----	---	---



Fireside Grand Oak Outdoor Gas Log Sets



Fireside Realwood Outdoor Gas Log Sets

Miscellaneous

Cottagewood Drain Pans

ODCTGWD-DP42	Drain pan for the 42" Cottagewood	HTI 3	\$	189	8	14	14	14	Y
--------------	-----------------------------------	-------	----	-----	---	----	----	----	---

Freestanding Kits

ODCTGWD-FSK42	Extended smoke shelf for use when unit is installed as a freestanding fireplace and the venting is reduced below the required minimum. See install manual for requirements.	HTI 3	\$	199	8	14	14	14	Y
---------------	-----------------------------------------------------------------------------------------------------------------------------------------------------------------------------	-------	----	-----	---	----	----	----	---

Venting Notes

Requires SL1100 series chimney. See Venting section.

When utilizing extended smoke shield in the ODCTGWD-FSK (36/42), the unit is installed as a freestanding fireplace and the venting can be reduced to 9.5' min. See install manual for requirements.

Canada uses SL400 series chimney and requires SLA-10 and CAK5A

Villawood 36

Includes:

- Traditional or herringbone brick interior
- Grate
- Stainless steel mesh curtain screens
- Dual gas knockouts
- Outside air standard
- UL & ULC listed
- 36" x 20-7/8" viewing area



No additional items required to complete.

		Disc. Code	MSRP USD	004 IA	010 PA	014 CA	016 NC	EXP
ODVILLA-36T-B	36" Outdoor Villa Wood Firebox - Traditional Refractory	HTI 3	\$ 1,479	Y	Y	Y	Y	N
ODVILLA-36H-B	36" Outdoor Villa Wood Firebox - Herringbone Refractory	HTI 3	\$ 1,529	Y	14	14	14	N

Doors - Operable

Villawood Glass Door 36

ODVGF-36	36" Bi-fold glass doors	HTI 3	\$ 569	Y	21	14	14	Y
----------	-------------------------	-------	--------	---	----	----	----	---



Villawood Glass Door 36

Gas Logs - Log Set Option

Fireside Realwood Gas Log Sets

FRW118	18" Fireside Realwood refractory cement log set (order hearth kit separately)	HTI 3	\$ 189	Y	21	Y	21	N
--------	-------------------------------------------------------------------------------	-------	--------	---	----	---	----	---

Fireside Realwood Outdoor Gas Log Sets

OD-18NG	18" matchlight hearth kit for outdoor fireplaces - 62,000 Btu/Hour Input (NG only)	HTI 3	\$ 839	21	21	21	21	N
ODSP-18LP	18" safety pilot hearth kit for outdoor fireplaces - 55,000 Btu/Hour Input LP (Note: Controls are located on the right and may offset the unit in the fireplace. Choose hearth size accordingly. See installation manual for hearth dimensions.)	HTI 3	\$ 969	21	21	28	21	N



Fireside Realwood Gas Log Sets



Fireside Realwood Outdoor Gas Log Sets

Options & Accessories

Options & Accessories

ODVILLA-36DP	Drain Pan for 36" ODVILLA	HTI 3	\$	159	8	14	14	14	Y
--------------	---------------------------	-------	----	-----	---	----	----	----	---

Venting Notes

Requires SL300 series pipe. See Venting section.

Villawood 42

Includes:

- Traditional or herringbone brick interior
- Grate
- Stainless steel mesh curtain screens
- Dual gas knockouts
- Outside air standard
- UL & ULC listed
- 42" x 20-7/8" viewing area



No additional items required to complete.

		Disc. Code	MSRP USD	004 IA	010 PA	014 CA	016 NC	EXP
ODVILLA-42T-B	42" Outdoor Villa Wood Firebox - Traditional Refractory	HTI 3	\$ 1,689	Y	Y	Y	Y	N
ODVILLA-42H-B	42" Outdoor Villa Wood Firebox - Herringbone Refractory	HTI 3	\$ 1,739	Y	14	14	Y	N

Doors - Operable

Villawood Glass Door 42

ODVGF-42	42" Bi-fold glass doors	HTI 3	\$ 709	Y	21	14	14	Y
----------	-------------------------	-------	--------	---	----	----	----	---



Villawood Glass Door 42

Gas Logs - Log Set Option

Fireside Realwood Gas Log Sets

FRW124	24" Fireside Realwood refractory cement log set (order hearth kit separately)	HTI 3	\$ 229	Y	14	Y	Y	N
--------	-------------------------------------------------------------------------------	-------	--------	---	----	---	---	---

Fireside Realwood Outdoor Gas Log Sets

OD-24NG	24" matchlight hearth kit for outdoor fireplaces - 69,000 Btu/Hour Input (NG only)	HTI 3	\$ 1,009	Y	21	21	21	N
ODSP-24LP	24" safety pilot hearth kit for outdoor fireplaces - 61,000 Btu/Hour input LP (Note: Controls are located on the right and may offset the unit in the fireplace. Choose hearth size accordingly. See installation manual for hearth dimensions.)	HTI 3	\$ 1,079	21	21	21	21	N



Fireside Realwood Gas Log Sets



Fireside Realwood Outdoor Gas Log Sets

Options & Accessories

Options & Accessories

ODVILLA-42DP	Drain Pan for 36" ODVILLA	HTI 3	\$	169	8	14	14	14	Y
--------------	---------------------------	-------	----	-----	---	----	----	----	---

Venting Notes

Requires SL300 series pipe. See Venting section.

Hearth & Home Technologies

Fireplace Outdoor - Gas - Multi-Sided

Stocked Item/Lead Time

004=Mt. Pleasant RDC
010=Kutztown RDC
014=Sacramento RDC
016=Charlotte RDC

EXP=Factory Expedite Program

Prices in USD

Page printed 2/1/2024 3:05:35 PM CST

Future pricing effective for shipments on or after 03/31/2024

* Please Contact Who You Purchase This Through for MSRP Pricing

Non-stock and custom product cannot be cancelled.

Customer is responsible for freight for orders made outside of assigned RDC facility.

Fortress 36 Indoor/Outdoor See-Through Gas Fireplace

Includes:

- Anti-reflective glass
- Touch screen remote control (RC400)
- Halogen accent lights
- Factory installed outdoor kit
- Both Indoor and Outdoor Screen
- 56,000 BTUs
- 36" x 30" viewing area
- CSA design certified
- Not available for sale in Rhode Island



Required to Complete - Sold Separately:

- Traditional or herringbone brick interior.
- Units are built NG. Conversion kit required for LP.

		Disc. Code	MSRP USD	004 IA	010 PA	014 CA	016 NC	EXP
ODFORTG-36	Fortress indoor/outdoor gas fireplace with IntelliFire Touch ignition system, see-through	HTI 3	\$ 9,779	Y	Y	Y	Y	N

Brick Panels (Required to Complete)

Fortress Brick Panels

ODFORTG36-IT	Fortress traditional brick refractory	HTI 3	\$ 449	Y	Y	Y	Y	N
ODFORTG36-IH	Fortress herringbone brick refractory	HTI 3	\$ 499	Y	Y	14	Y	N

Conversion Kit

Conversion Kit

LPK-ODFORTG-36	LP conversion kit for Fortress	HTI 3	\$ 99	Y	Y	Y	Y	Y
----------------	--------------------------------	-------	-------	---	---	---	---	---

Control, remotes, wall switches

IntelliFire app

IFT-WFM	IntelliFire Wi-Fi Module that works with the IntelliFire iOS and Android app. Use to control all the features of your fireplace via a smart device. An RC400, RC450 or RC150 is required for thermostat control	HTI 1	\$ 219	Y	Y	Y	Y	Y
---------	-----------------------------------------------------------------------------------------------------------------------------------------------------------------------------------------------------------------	-------	--------	---	---	---	---	---

Remote/Wall Switch/Wall Thermostat

IFT-RC150	IntelliFire Touch white wireless wall switch (on/off, cold climate, battery strength indicator)	HTI 1	\$ 116	Y	14	14	Y	Y
-----------	-------------------------------------------------------------------------------------------------	-------	--------	---	----	----	---	---

Touch Screen Remote

IFT-RC400	IntelliFire Touch black remote control, docking station and auxiliary control module (on/off, flame height, thermostat mode, fan control, child lock, cold climate, timer mode, hot indicator, lights, on-screen maintenance and troubleshooting notifications)	HTI 1	\$ 379	Y	Y	Y	Y	Y
-----------	-----------------------------------------------------------------------------------------------------------------------------------------------------------------------------------------------------------------------------------------------------------------	-------	--------	---	---	---	---	---

Wall Switch

IFT-RC150-HNG	IntelliFire Touch white wireless wall switch (on/off, cold climate, battery strength indicator)	HNG 1	\$	116	Y	Y	Y	Y	Y
IFT-RC150-HTL	IntelliFire Touch white wireless wall switch (on/off, cold climate, battery strength indicator)	HTL 1	\$	116	Y	14	14	Y	Y



IntelliFire app

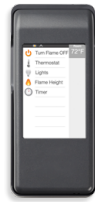

Touch Screen Remote



Wall Switch

Venting Notes

Requires 8" DVP pipe. Must have a 24" minimum vertical vent before attaching a 90° elbow to unit. See venting section.

Approved for use with PVLP-SLP and PVI-SLP-B with power vent wire harness (order separately). See venting section of manual.

Lanai 48 See-Through

Includes:

- Multi-colored LED lights
- Crystal glass media
- Glass wind guards
- Wall control with LED lights
- Gas flex connector
- 15' wire harness for wall control
- 48" x 17" viewing area
- 55,000 BTUs
- UL/ULC listed



Required to Complete - Sold Separately: • Units are built NG. Conversion kit required for LP.

		Disc. Code	MSRP USD	004 IA	010 PA	014 CA	016 NC	EXP
ODLANAIGST-48	48" Lanai outdoor linear fireplace with IntelliFire Ignition, See-through	HTI 3	\$ 4,809	Y	14	14	14	N

Conversion Kit

Conversion Kit

LPK-ODLANAIG48	LP Conversion Kit - 48" Lanai	HTI 3	\$ 129	Y	Y	Y	Y	Y
----------------	-------------------------------	-------	--------	---	---	---	---	---

Firescreens

Lanai Screen

ODLANAIG-48SCN	Framed Screen Barrier - 48" Lanai	HTI 3	\$ 399	Y	Y	Y	Y	Y
----------------	-----------------------------------	-------	--------	---	---	---	---	---



Lanai Screen

Clean Face Kit

Lanai CF Kit

ODLANAIG-48CFT	Clean Face Trim Kit - 48" Lanai	HTI 3	\$ 269	Y	14	14	14	Y
----------------	---------------------------------	-------	--------	---	----	----	----	---

Gas Logs - Log Set Option

Log Accessories

CDLS	Driftwood Log Set	HTI 1	\$ 569	Y	Y	14	Y	Y
------	-------------------	-------	--------	---	---	----	---	---

Media

Crushed Glass Media

MEDIA-CLEAR-48	Glass media, crystal (translucent white)	HTI 1	\$ 249	Y	Y	Y	Y	Y
MEDIA-AMBER-48	Glass media, amber	HTI 1	\$ 359	Y	Y	Y	Y	Y
MEDIA-COBALT-48	Glass media, cobalt (blue)	HTI 1	\$ 359	Y	21	Y	14	Y
MEDIA-EBONY-48	Glass media, ebony (black)	HTI 1	\$ 359	Y	Y	Y	Y	Y
MEDIA-RED-48	Glass media, scarlet (red)	HTI 1	\$ 359	14	21	14	14	Y

MEDIA

STONEKIT	Stone Kit	HTI 1	\$	146	Y	Y	Y	Y	Y
----------	-----------	-------	----	-----	---	---	---	---	---

Options & Accessories

Options & Accessories

ODLANAIG-48DP	Drain Pan - 48" Lanai	HTI 3	\$	219	Y	14	14	14	Y
---------------	-----------------------	-------	----	-----	---	----	----	----	---

Venting Notes

No venting is required for this unit

Twilight Indoor/Outdoor See-Through Gas Fireplace

Includes:

- 38,000 Btu/Hour Input (NG)
- 36,000 Btu/Hour Input (LP)
- Gas flex connector
- Traditional refractory
- Junction box
- 7 ceramic fiber logs
- Manual gas shut-off valve
- Glowing embers
- Battery backup
- Exterior front
- IntelliFire Touch ignition system



Required to Complete - Sold Separately:

- 1 interior front
- Units are built NG. Conversion kit required for LP.
- Advanced Install Product training required before product ships

		Disc. Code	MSRP USD	004 IA	010 PA	014 CA	016 NC	EXP
TWILIGHT-IFT	Twilight 36" Indoor/Outdoor See-Through Gas Fireplace with IntelliFire (NG)	HTI 3	\$ 7,089	Y	Y	Y	Y	N

Fronts - Non-Operable (Required to Complete)

Twilight Firescreen

FS-TWI-BK	Firescreen front - Black	HTI 3	\$ 449	Y	Y	Y	Y	Y
-----------	--------------------------	-------	--------	---	---	---	---	---

Twilight Modern Fronts

TWI-MOD-BK	Contemporary front with built in, overlapping surround - Black	HTI 3	\$ 729	14	14	14	14	N
------------	----------------------------------------------------------------	-------	--------	----	----	----	----	---



Twilight Firescreen



Twilight Modern Fronts

Conversion Kit

Conversion Kit

NGK-MC-C	NG Conversion Kit	HTI 1	\$ 99	14	14	14	14	Y
LPK-TWI-IFT	LP Conversion Kit	HTI 3	\$ 99	Y	Y	Y	Y	Y

Fans

Fan

GFK-160T	Blower Assembly - Cannot install fan if ordering a modern front	HTI 1	\$ 339	Y	Y	Y	Y	Y
----------	-----------------------------------------------------------------	-------	--------	---	---	---	---	---

Control, remotes, wall switches

Battery Back Up

BATTERY-WSK	Battery backup wall switch kit for units with IFT control systems. Includes: On/Off Wall Switch, USB-C Port, Battery Backup, Cover Plate, 12' Wire Harness	HTI 1	\$ 179	Y	14	14	14	Y
-------------	------------------------------------------------------------------------------------------------------------------------------------------------------------	-------	--------	---	----	----	----	---

IntelliFire app						
IFT-WFM	IntelliFire Wi-Fi Module that works with the IntelliFire iOS and Android app. Use to control all the features of your fireplace via a smart device. An RC400, RC450 or RC150 is required for thermostat control	HTI 1	\$	219	Y	Y
IntelliFire Touch Controls - Aux Module						
IFT-ACM	IntelliFire Touch AUX Module. Must order if adding Fan, Lights or Power Vent and want to use the IFT-WFM. Do not need to order if using IFT-RC400 (includes IFT-ACM).	HTI 1	\$	96	14	Y
Remote/Wall Switch/Wall Thermostat						
IFT-RC150	IntelliFire Touch white wireless wall switch (on/off, cold climate, battery strength indicator)	HTI 1	\$	116	Y	14
Touch Screen Remote						
IFT-RC400	IntelliFire Touch black remote control, docking station and auxiliary control module (on/off, flame height, thermostat mode, fan control, child lock, cold climate, timer mode, hot indicator, lights, on-screen maintenance and troubleshooting notifications)	HTI 1	\$	379	Y	Y
Wall Switch						
IFT-RC150-HNG	IntelliFire Touch white wireless wall switch (on/off, cold climate, battery strength indicator)	HNG 1	\$	116	Y	Y
IFT-RC150-HTL	IntelliFire Touch white wireless wall switch (on/off, cold climate, battery strength indicator)	HTL 1	\$	116	Y	14



Battery Back Up



IntelliFire app

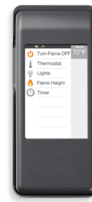

Touch Screen Remote



Wall Switch

Venting Notes
 No venting is required with this unit.

Twilight Modern Indoor/Outdoor See-Through Gas Fireplace

Includes:

- 38,000 Btu/Hour Input (NG)
- 36,000 Btu/Hour Input (LP)
- Black glass media
- Reflective black glass refractory
- Gas flex connector
- Manual gas shut-off valve
- Junction box
- Battery backup
- Exterior front
- IntelliFire Touch ignition system



Required to Complete - Sold Separately:

- 1 non-operable front required for interior
- Units are built NG. Conversion kit required for LP.
- Advanced Install Product training required before product ships

		Disc. Code	MSRP USD	004 IA	010 PA	014 CA	016 NC	EXP
TWILIGHT-MD-IFT	Twilight Modern 36" Indoor/Outdoor See-Through Gas Fireplace contemporary with Intellifire (NG)	HTI 3	\$ 7,559	Y	14	Y	14	N

Fronts - Non-Operable (Required to Complete)

Twilight Firescreen

FS-TWI-BK	Firescreen front - Black	HTI 3	\$ 449	Y	Y	Y	Y	Y
-----------	--------------------------	-------	--------	---	---	---	---	---

Twilight Modern Fronts

TWI-MOD-BK	Contemporary front with built in, overlapping surround - Black	HTI 3	\$ 729	14	14	14	14	N
------------	----------------------------------------------------------------	-------	--------	----	----	----	----	---



Twilight Firescreen



Twilight Modern Fronts

Conversion Kit

Conversion Kit

NGK-MC-C	NG Conversion Kit	HTI 1	\$ 99	14	14	14	14	Y
LPK-TWI-IFT	LP Conversion Kit	HTI 3	\$ 99	Y	Y	Y	Y	Y

Media

Crushed Glass Media

MEDIA-BLACK-20	Glass media, Ebony (black)	HTI 1	\$ 249	14	21	14	14	N
MEDIA-AMBER-20	Glass media, Amber	HTI 1	\$ 259	14	21	14	14	Y
MEDIA-CRYSTAL21	Glass media, Crystal (translucent white) - 21 lbs	HTI 3	\$ 279	14	21	14	14	N

Fans

Fan

GFK-160T	Blower Assembly - Cannot install fan if ordering a modern front	HTI 1	\$ 339	Y	Y	Y	Y	Y
----------	-----------------------------------------------------------------	-------	--------	---	---	---	---	---

Control, remotes, wall switches								
Battery Back Up								
BATTERY-WSK	Battery backup wall switch kit for units with IFT control systems. Includes: On/Off Wall Switch, USB-C Port, Battery Backup, Cover Plate, 12' Wire Harness	HTI 1	\$ 179	Y	14	14	14	Y
IntelliFire app								
IFT-WFM	IntelliFire Wi-Fi Module that works with the IntelliFire iOS and Android app. Use to control all the features of your fireplace via a smart device. An RC400, RC450 or RC150 is required for thermostat control	HTI 1	\$ 219	Y	Y	Y	Y	Y
IntelliFire Touch Controls - Aux Module								
IFT-ACM	IntelliFire Touch AUX Module. Must order if adding Fan, Lights or Power Vent and want to use the IFT-WFM. Do not need to order if using IFT-RC400 (includes IFT-ACM).	HTI 1	\$ 96	14	Y	14	14	Y
Remote/Wall Switch/Wall Thermostat								
IFT-RC150	IntelliFire Touch white wireless wall switch (on/off, cold climate, battery strength indicator)	HTI 1	\$ 116	Y	14	14	Y	Y
Touch Screen Remote								
IFT-RC400	IntelliFire Touch black remote control, docking station and auxiliary control module (on/off, flame height, thermostat mode, fan control, child lock, cold climate, timer mode, hot indicator, lights, on-screen maintenance and troubleshooting notifications)	HTI 1	\$ 379	Y	Y	Y	Y	Y
Wall Switch								
IFT-RC150-HNG	IntelliFire Touch white wireless wall switch (on/off, cold climate, battery strength indicator)	HNG 1	\$ 116	Y	Y	Y	Y	Y
IFT-RC150-HTL	IntelliFire Touch white wireless wall switch (on/off, cold climate, battery strength indicator)	HTL 1	\$ 116	Y	14	14	Y	Y



Battery Back Up



IntelliFire app

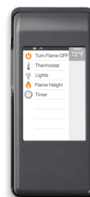

Touch Screen Remote



Wall Switch

Venting Notes
 No venting is required with this unit.

<h1 style="margin: 0;">Hearth & Home Technologies</h1>	<h2 style="margin: 0;">Mantels - Flush Wood</h2>	<p>Stocked Item/Lead Time</p> <p>004=Mt. Pleasant RDC 010=Kutztown RDC 014=Sacramento RDC 016=Charlotte RDC</p> <p>EXP=Factory Expedite Program</p>
------------------------------------------------------------	--------------------------------------------------	-----------------------------------------------------------------------------------------------------------------------------------------------------------------

Prices in USD

Page printed 2/1/2024 3:05:35 PM CST
* Please Contact Who You Purchase This Through for MSRP Pricing

Non-stock and custom product cannot be cancelled.
Customer is responsible for freight for orders made outside of assigned RDC facility.

Stained and Custom Flush Mantels, Cabinets and Shelves

For any stain order, an upcharge of \$300-320 (\$300 for 48", \$310 for 59", \$320 for 72") for each shelf and \$420-\$440 (\$420 for A size, \$430 for B size and \$440 for C size) mantel is added to the MSRP. When ordering, the SKU to order requires a dash and appropriate color letter to the standard SKU number: Example: FMCYMP48-P, Crosby shelf in Provincial Brown. See below for proper SKU. Non-stock lead times apply.

-P = Provincial -NG = New Gray -WW = Whitewash -E = Ebony

Custom sizing available on request (for maple only). Please complete custom mantel order form and submit to your Customer Service representative.

To find this form in the new myHHT portal:

1. In the search bar at the top of the page, type "Custom Mantel Stain Order Form" and press enter.
2. Click the download icon on the left side of the search result and the file will begin downloading to your computer.

Acadia A									
					Disc. Code	MSRP USD	004 IA	010 PA	014 CA
	AFAAMPA	Acadia Flush Mantel, Primed MDF	HTI 1	\$ 729	21	Y	21	Y	N
	AFAAAUA	Acadia Flush Mantel, Unfinished Maple	HTI 1	\$ 1,169	28	21	28	28	N

Acadia B									
					Disc. Code	MSRP USD	004 IA	010 PA	014 CA
	AFAAMPB	Acadia Flush Mantel, Primed MDF	HTI 1	\$ 779	Y	Y	14	Y	N
	AFAAAUB	Acadia Flush Mantel, Unfinished Maple	HTI 1	\$ 1,199	28	21	28	28	N

Acadia C



		Disc. Code	MSRP USD	004 IA	010 PA	014 CA	016 NC	EXP
AFAAMPC	Acadia Flush Mantel, Primed MDF	HTI 1	\$ 809	21	Y	21	Y	N
AFAAAUC	Acadia Flush Mantel, Unfinished Maple	HTI 1	\$ 1,239	28	Y	28	28	N

Battlefield B



		Disc. Code	MSRP USD	004 IA	010 PA	014 CA	016 NC	EXP
AFBDMPB	Battlefield Flush Mantel, Primed MDF	HTI 1	\$ 1,479	21	Y	21	21	N
AFBDKAB	Battlefield Flush Mantel, Unfinished Distressed Knotty Alder	HTI 1	\$ 2,219	28	21	28	28	N

Battlefield C



		Disc. Code	MSRP USD	004 IA	010 PA	014 CA	016 NC	EXP
AFBDMPC	Battlefield Mantel, Primed MDF	HTI 1	\$ 1,509	21	Y	21	21	N
AFBDKAC	Battlefield Flush Mantel, Unfinished Distressed Knotty Alder	HTI 1	\$ 2,249	28	21	28	28	N

Corbels



		Disc. Code	MSRP USD	004 IA	010 PA	014 CA	016 NC	EXP
AFCORBMP	Corbels (2), Primed MDF	HTI 1	\$ 103	42	Y	42	42	Y

Kenwood A



		Disc. Code	MSRP USD	004 IA	010 PA	014 CA	016 NC	EXP
AFKDMPA	Kenwood Flush Mantel Primed MDF	HTI 1	\$ 729	21	Y	21	Y	N
AFKDAUA	Kenwood Flush Mantel Maple Unfinished	HTI 1	\$ 1,169	28	21	28	28	N

Kenwood B



		Disc. Code	MSRP USD	004 IA	010 PA	014 CA	016 NC	EXP
AFKDMPB	Kenwood Flush Mantel Primed MDF	HTI 1	\$ 779	Y	Y	Y	Y	N
AFKDAUB	Kenwood Flush Mantel Maple Unfinished	HTI 1	\$ 1,199	Y	Y	35	21	N

Kenwood B60



		Disc. Code	MSRP USD	004 IA	010 PA	014 CA	016 NC	EXP
AFKDMPB60	Kenwood Flush Mantel, Primed MDF; 60" outside width	HTI 1	\$ 779	Y	Y	21	Y	N

Kenwood C



		Disc. Code	MSRP USD	004 IA	010 PA	014 CA	016 NC	EXP
AFKDMPC	Kenwood Flush Mantel Primed MDF	HTI 1	\$ 809	Y	Y	14	Y	N
AFKDAUC	Kenwood Flush Mantel Maple Unfinished	HTI 1	\$ 1,239	28	21	28	28	N

Laurel B



		Disc. Code	MSRP USD	004 IA	010 PA	014 CA	016 NC	EXP
AFLLMPAUB	LAUREL MANTEL MDF/MAPLE	HTI 1	\$ 1,909	21	Y	35	21	N
AFLLMPAUB-P	Laurel Mantel, Primed MDF & Maple top with Provincial Stain	HTI 1	\$ 2,219	21	Y	35	21	N
AFLLMPAUB-WW	Laurel Mantel, Primed MDF & Maple top with Whitewash Stain	HTI 1	\$ 2,219	28	21	28	28	N
AFLLMPAUB-E	Laurel Mantel, Primed MDF & Maple top with Ebony Stain	HTI 1	\$ 2,219	28	21	28	28	N
AFLLMPAUB-NG	Laurel Mantel, Primed MDF & Maple top with New Gray Stain	HTI 1	\$ 2,219	28	21	28	28	N

Laurel C



		Disc. Code	MSRP USD	004 IA	010 PA	014 CA	016 NC	EXP
AFLLMPAUC	LAUREL MANTEL MDF/MAPLE	HTI 1	\$ 1,939	28	21	28	28	N
AFLLMPAUC-WW	Laurel Mantel, Primed MDF & Maple top with Whitewash Stain	HTI 1	\$ 2,239	28	21	28	28	N
AFLLMPAUC-E	Laurel Mantel, Primed MDF & Maple top with Ebony Stain	HTI 1	\$ 2,239	28	21	28	28	N
AFLLMPAUC-NG	Laurel Mantel, Primed MDF & Maple top with New Gray Stain	HTI 1	\$ 2,239	28	21	28	28	N
AFLLMPAUC-P	Laurel Mantel, Primed MDF & Maple top with Provincial Stain	HTI 1	\$ 2,239	28	21	28	28	N

Malone B



		Disc. Code	MSRP USD	004 IA	010 PA	014 CA	016 NC	EXP
AFMEMPB	Malone Mantel, Primed MDF	HTI 1	\$ 1,479	21	Y	21	Y	N

Malone C



		Disc. Code	MSRP USD	004 IA	010 PA	014 CA	016 NC	EXP
AFMEMPC	Malone Mantel, Primed MDF	HTI 1	\$ 1,509	21	Y	21	Y	N

Merritt A



		Disc. Code	MSRP USD	004 IA	010 PA	014 CA	016 NC	EXP
AFMTMPA	Merritt Mantel, Primed MDF	HTI 1	\$ 729	21	Y	21	Y	N

Merritt B



		Disc. Code	MSRP USD	004 IA	010 PA	014 CA	016 NC	EXP
AFMTMPB	Merritt Mantel, Primed MDF	HTI 1	\$ 779	21	Y	21	Y	N

Merritt C



	Disc. Code	MSRP USD	004	010	014	016	EXP
			IA	PA	CA	NC	
AFMTMPC	HTI 1	\$ 809	21	Y	21	21	N

Richland A



	Disc. Code	MSRP USD	004	010	014	016	EXP
			IA	PA	CA	NC	
AFRDMPA	HTI 1	\$ 559	21	Y	21	Y	N

Richland B



	Disc. Code	MSRP USD	004	010	014	016	EXP
			IA	PA	CA	NC	
AFRDMPB	HTI 1	\$ 619	Y	Y	21	Y	N

Richland C



	Disc. Code	MSRP USD	004	010	014	016	EXP
			IA	PA	CA	NC	
AFRDMPA	HTI 1	\$ 649	21	Y	21	Y	N

Richland RS



	Disc. Code	MSRP USD	004	010	014	016	EXP
			IA	PA	CA	NC	
AFRDMPARS	HTI 1	\$ 539	21	Y	21	Y	N

Roxborough A



	Disc. Code	MSRP USD	004	010	014	016	EXP
			IA	PA	CA	NC	
AFRHMPA	HTI 1	\$ 729	Y	Y	21	Y	N

Roxborough B



	Disc. Code	MSRP USD	004	010	014	016	EXP
			IA	PA	CA	NC	
AFRHMPB	HTI 1	\$ 779	Y	Y	21	Y	N

Roxborough C



	Disc. Code	MSRP USD	004	010	014	016	EXP
			IA	PA	CA	NC	
AFRHMPC	HTI 1	\$ 809	21	Y	21	Y	N

Walker B



	Disc. Code	MSRP USD	004	010	014	016	EXP
			IA	PA	CA	NC	
AFWKMPB	HTI 1	\$ 1,479	21	Y	21	Y	N

Walker C



	Disc. Code	MSRP USD	004	010	014	016	EXP
			IA	PA	CA	NC	
AFWKMPC	HTI 1	\$ 1,509	21	Y	21	21	N

Wescott A



	Disc. Code	MSRP USD	004	010	014	016	EXP
			IA	PA	CA	NC	
AFWTMPA	HTI 1	\$ 559	Y	Y	14	Y	N

Wescott B



	Disc. Code	MSRP USD	004	010	014	016	EXP
			IA	PA	CA	NC	
AFWTMPB	HTI 1	\$ 619	Y	Y	21	Y	N

Wescott C



	Disc. Code	MSRP USD	004	010	014	016	EXP
			IA	PA	CA	NC	
AFWTMPC	HTI 1	\$ 649	21	Y	21	Y	N

Zimmer A



	Disc. Code	MSRP USD	004	010	014	016	EXP
			IA	PA	CA	NC	
AFZRMPA	HTI 1	\$ 729	21	Y	21	21	N

Zimmer B



	Disc. Code	MSRP USD	004	010	014	016	EXP
			IA	PA	CA	NC	
AFZRMPB	HTI 1	\$ 779	21	Y	21	Y	N

Zimmer C

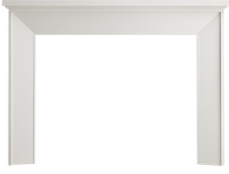

		Disc. Code	MSRP USD	004 IA	010 PA	014 CA	016 NC	EXP
AFZRMPC	Zimmer Mantel, Primed MDF	HTI 1	\$ 809	21	Y	21	21	N

<h1>Hearth & Home Technologies</h1>	<h2>Optional Wood Mantel Base</h2>	<p>Stocked Item/Lead Time</p> <p>004=Mt. Pleasant RDC 010=Kutztown RDC 014=Sacramento RDC 016=Charlotte RDC</p> <p>EXP=Factory Expedite Program</p>
-----------------------------------------	------------------------------------	-----------------------------------------------------------------------------------------------------------------------------------------------------------------

Prices in USD

Page printed 2/1/2024 3:05:35 PM CST
* Please Contact Who You Purchase This Through for MSRP Pricing

Non-stock and custom product cannot be cancelled.
Customer is responsible for freight for orders made outside of assigned RDC facility.

Kenwood A Flush Mantel Base

		Disc. Code	MSRP USD	004 IA	010 PA	014 CA	016 NC	EXP
	HTKDMPA	Kenwood - Optional Base Primed MDF	HTI 1 \$ 399	21	Y	21	Y	N
	HTKDAUA	Kenwood - Optional Base Maple Unfinished	HTI 1 \$ 779	28	21	28	28	N

Kenwood B Flush Mantel Optional Base

		Disc. Code	MSRP USD	004 IA	010 PA	014 CA	016 NC	EXP
	HTKDMPB	Kenwood - Optional Base Primed MDF	HTI 1 \$ 429	21	Y	28	Y	N
	HTKDAUB	Kenwood - Optional Base Maple Unfinished	HTI 1 \$ 799	28	21	28	28	N

Kenwood C Flush Mantel Optional Base

		Disc. Code	MSRP USD	004 IA	010 PA	014 CA	016 NC	EXP
	HTKDMPC	Kenwood - Optional Base Primed MDF	HTI 1 \$ 459	28	28	35	35	N
	HTKDAUC	Kenwood - Optional Base Maple Unfinished	HTI 1 \$ 829	28	21	28	28	N

<h1>Hearth & Home Technologies</h1>	<h2>Samples - Wood Mantel Shoulder</h2>	Stocked Item/Lead Time 004=Mt. Pleasant RDC 010=Kutztown RDC 014=Sacramento RDC 016=Charlotte RDC EXP=Factory Expedite Program
-----------------------------------------	-----------------------------------------	-------------------------------------------------------------------------------------------------------------------------------------------------------

Page printed 2/1/2024 3:05:35 PM CST
 * Please Contact Who You Purchase This Through for MSRP Pricing

Prices in USD

Non-stock and custom product cannot be cancelled.
 Customer is responsible for freight for orders made outside of assigned RDC facility.

Acadia Mantel Sample



	Disc. Code	MSRP USD	HTI	null	\$	107	004	010	014	016	EXP
							IA	PA	CA	NC	
AFAAMPY		ACADIA MANTEL SAMPLE	HTI	null	\$	107	21	Y	21	21	N

Battlefield Mantel Sample



	Disc. Code	MSRP USD	HTI	null	\$	107	004	010	014	016	EXP
							IA	PA	CA	NC	
AFBDMPY		BATTLEFIELD MANTEL SAMPLE	HTI	null	\$	107	28	Y	28	28	N

Kenwood Wood Mantel Sample - Primed MDF



	Disc. Code	MSRP USD	HTI	null	\$	107	004	010	014	016	EXP
							IA	PA	CA	NC	
AFKDMPY		Kenwood mantel shoulder sample - Primed MDF	HTI	null	\$	107	42	Y	42	42	Y

Laurel Mantel Sample



	Disc. Code	MSRP USD	HTI	1	\$	239	004	010	014	016	EXP
							IA	PA	CA	NC	
AFLLMPAUY-NG		Laurel Mantel Sample, Primed MDF & Maple top with New Gray Stain	HTI	1	\$	239	28	21	28	28	N
AFLLMPAUY-E		Laurel Mantel Sample, Primed MDF & Maple top with Ebony Stain	HTI	1	\$	239	28	21	28	28	N
AFLLMPAUY-WW		Laurel Mantel Sample, Primed MDF & Maple top with Whitewash Stain	HTI	1	\$	239	28	21	28	28	N
AFLLMPAUY-P		Laurel Mantel Sample, Primed MDF & Maple top with Provincial Stain	HTI	1	\$	239	28	21	28	28	N

Malone Mantel Sample



	Disc. Code	MSRP USD	004	010	014	016	EXP		
			IA	PA	CA	NC			
AFMEMPY		Malone Mantel Sample, Primed MDF	HTI 1	\$	107	21	Y	21	Y

Merritt Mantel Sample

	Disc. Code	MSRP USD	004	010	014	016	EXP		
			IA	PA	CA	NC			
AFMTMPY		Merritt Mantel Sample, Primed MDF	HTI 1	\$	107	21	Y	21	Y

Richland Mantel Sample



	Disc. Code	MSRP USD	004	010	014	016	EXP			
			IA	PA	CA	NC				
AFRDMPY		RICHLAND MANTEL SAMPLE	HTI null	\$	107	21	Y	14	21	N

Roxborough Mantel Sample



	Disc. Code	MSRP USD	004	010	014	016	EXP			
			IA	PA	CA	NC				
AFRHMPY		ROXBOROUGH MANTEL SAMPLE	HTI null	\$	107	28	Y	28	28	N

Walker Mantel Sample



	Disc. Code	MSRP USD	004	010	014	016	EXP			
			IA	PA	CA	NC				
AFWKMPY		Walker Mantel Sample, Primed MDF	HTI 1	\$	107	21	14	21	21	Y

Wescott Mantel Sample



	Disc. Code	MSRP USD	004	010	014	016	EXP			
			IA	PA	CA	NC				
AFWTMPY		WESCOTT MANTEL SAMPLE	HTI null	\$	107	21	Y	14	21	N

Zimmer Mantel Sample



		Disc. Code	MSRP USD	004 IA	010 PA	014 CA	016 NC	EXP
AFZRMPY	Zimmer Mantel Sample, Primed MDF	HTI 1	\$ 107	21	Y	21	21	Y

<h1>Hearth & Home Technologies</h1>	<h2>Samples - Non-Combustible Shelf Shoulder</h2>	<p>Stocked Item/Lead Time</p> <p>004=Mt. Pleasant RDC 010=Kutztown RDC 014=Sacramento RDC 016=Charlotte RDC</p> <p>EXP=Factory Expedite Program</p>
-----------------------------------------	---------------------------------------------------	-----------------------------------------------------------------------------------------------------------------------------------------------------------------

Page printed 2/1/2024 3:05:35 PM CST
* Please Contact Who You Purchase This Through for MSRP Pricing

Prices in USD

Non-stock and custom product cannot be cancelled.
Customer is responsible for freight for orders made outside of assigned RDC facility.

Non-Combustible Cove Gray 18"



	Disc. Code	MSRP USD	004	010	014	016	EXP
			IA	PA	CA	NC	
FMSGNCY	HTI 1	\$ 289	14	Y	21	21	Y

Non-Combustible Midnight Mist 18"



	Disc. Code	MSRP USD	004	010	014	016	EXP
			IA	PA	CA	NC	
FMMMNCY	HTI 1	\$ 289	14	Y	21	14	Y

Non-Combustible Tavern Brown 18"



	Disc. Code	MSRP USD	004	010	014	016	EXP
			IA	PA	CA	NC	
FMTBNCY	HTI 1	\$ 289	14	Y	21	14	Y

Non-Combustible Washed Cedar 18"



	Disc. Code	MSRP USD	004	010	014	016	EXP
			IA	PA	CA	NC	
FMWCNCY	HTI 1	\$ 289	14	Y	21	14	Y

Non-Combustible Weathered Barnwood 18"



	Disc. Code	MSRP USD	004	010	014	016	EXP
			IA	PA	CA	NC	
FMWBNCY	HTI 1	\$ 289	14	Y	21	14	Y

Non-Combustible White 18"



	Disc. Code	MSRP USD	004	010	014	016	EXP
			IA	PA	CA	NC	
FMWHNCY	HTI 1	\$ 289	14	Y	21	14	Y

<h1>Hearth & Home Technologies</h1>	<h2>Mantels - Shelf Wood</h2>	Stocked Item/Lead Time 004=Mt. Pleasant RDC 010=Kutztown RDC 014=Sacramento RDC 016=Charlotte RDC EXP=Factory Expedite Program
-----------------------------------------	-------------------------------	-------------------------------------------------------------------------------------------------------------------------------------------------------

Prices in USD

Page printed 2/1/2024 3:05:35 PM CST
 * Please Contact Who You Purchase This Through for MSRP Pricing

Non-stock and custom product cannot be cancelled.
 Customer is responsible for freight for orders made outside of assigned RDC facility.

Stained and Custom Flush Mantels, Cabinets and Shelves



For any stain order, an upcharge of \$300-320 (\$300 for 48", \$310 for 59", \$320 for 72") for each shelf and \$420-\$440 (\$420 for A size, \$430 for B size and \$440 for C size) mantel is added to the MSRP. When ordering, the SKU to order requires a dash and appropriate color letter to the standard SKU number: Example: FMCYMP48-P, Crosby shelf in Provincial Brown. See below for proper SKU. Non-stock lead times apply.

-P = Provincial -NG = New Gray -WW = Whitewash -E = Ebony

Custom sizing available on request (for maple only). Please complete custom mantel order form and submit to your Customer Service representative.

To find this form in the new myHHT portal:

1. In the search bar at the top of the page, type "Custom Mantel Stain Order Form" and press enter.
2. Click the download icon on the left side of the search result and the file will begin downloading to your computer.

Baxter 48"		Disc.	MSRP	004	010	014	016	EXP
		Code	USD	IA	PA	CA	NC	
	FMBRMP48	48" Baxter Shelf, Primed MDF	HTI 1 \$ 519	21	Y	21	21	N
	FMBRAU48	48" Baxter Shelf, Unfinished Maple	HTI 1 \$ 919	28	21	28	28	N
Baxter 59"		Disc.	MSRP	004	010	014	016	EXP
		Code	USD	IA	PA	CA	NC	
	FMBRMP59	59" Baxter Shelf, Primed MDF	HTI 1 \$ 549	21	Y	21	21	N
	FMBRAU59	59" Baxter Shelf, Unfinished Maple	HTI 1 \$ 959	21	Y	35	21	N

Baxter 72"



		Disc. Code	MSRP USD	004 IA	010 PA	014 CA	016 NC	EXP
FMBRMP72	72" Baxter Shelf, Primed MDF	HTI 1	\$ 629	21	Y	21	21	N
FMBRAU72	72" Baxter Shelf, Unfinished Maple	HTI 1	\$ 999	21	Y	35	21	N

Crosby 48"



		Disc. Code	MSRP USD	004 IA	010 PA	014 CA	016 NC	EXP
FMCYMP48	48* CROSBY SHELF MDF	HTI 1	\$ 519	21	Y	21	21	N
FMCYAU48	Crosby 48, Unfinished Maple	HTI 1	\$ 919	28	21	28	28	N

Crosby 59"



		Disc. Code	MSRP USD	004 IA	010 PA	014 CA	016 NC	EXP
FMCYMP59	59" Crosby Shelf, Primed MDF	HTI 1	\$ 549	21	Y	21	21	N
FMCYAU59	59" Crosby Shelf, Unfinished Maple	HTI 1	\$ 959	21	Y	35	35	N

Crosby 72"



		Disc. Code	MSRP USD	004 IA	010 PA	014 CA	016 NC	EXP
FMCYMP72	72" Crosby Shelf, Primed MDF	HTI 1	\$ 629	21	Y	21	21	N
FMCYAU72	72" Crosby Shelf, Unfinished Maple	HTI 1	\$ 999	21	Y	35	21	N

Fillmore 48"



		Disc. Code	MSRP USD	004 IA	010 PA	014 CA	016 NC	EXP
FMFEMP48	48" Fillmore Primed MDF	HTI 1	\$ 369	Y	Y	14	28	N
FMFEAU48	48" Fillmore Unfinished Maple	HTI 1	\$ 559	28	21	28	28	N

Fillmore 59"

	Disc. Code	MSRP USD	004	010	014	016	EXP
			IA	PA	CA	NC	
 FMFEMP59	HTI 1	\$ 409	21	Y	21	Y	N
FMFEAU59	HTI 1	\$ 629	14	Y	14	21	N

Fillmore 72"

	Disc. Code	MSRP USD	004	010	014	016	EXP
			IA	PA	CA	NC	
 FMFEMP72	HTI 1	\$ 449	21	Y	21	21	N
FMFEAU72	HTI 1	\$ 659	28	21	28	28	N

Ozark 48"

	Disc. Code	MSRP USD	004	010	014	016	EXP
			IA	PA	CA	NC	
 FMOKMP48	HTI 1	\$ 699	21	Y	21	21	N
FMOKAU48	HTI 1	\$ 1,089	21	Y	35	Y	N
FMOKKA48	HTI 1	\$ 1,189	28	21	28	28	N

Ozark 59"

	Disc. Code	MSRP USD	004	010	014	016	EXP
			IA	PA	CA	NC	
 FMOKMP59	HTI 1	\$ 749	Y	Y	28	Y	N
FMOKAU59	HTI 1	\$ 1,159	Y	Y	14	Y	N
FMOKKA59	HTI 1	\$ 1,229	21	Y	35	Y	N

Ozark 72"

	Disc. Code	MSRP USD	004	010	014	016	EXP
			IA	PA	CA	NC	
 FMOKMP72	HTI 1	\$ 799	21	Y	14	Y	N
FMOKAU72	HTI 1	\$ 1,189	Y	Y	21	Y	N
FMOKKA72	HTI 1	\$ 1,259	21	Y	35	Y	N

<h1>Hearth & Home Technologies</h1>	<h2>Shelf Non-Combustible</h2>	<p>Stocked Item/Lead Time</p> <p>004=Mt. Pleasant RDC 010=Kutztown RDC 014=Sacramento RDC 016=Charlotte RDC</p> <p>EXP=Factory Expedite Program</p>
-----------------------------------------	--------------------------------	-----------------------------------------------------------------------------------------------------------------------------------------------------------------

Page printed 2/1/2024 3:05:35 PM CST
* Please Contact Who You Purchase This Through for MSRP Pricing

Prices in USD
Non-stock and custom product cannot be cancelled.
Customer is responsible for freight for orders made outside of assigned RDC facility.

Non-Combustible Cove Gray 60"

		Disc. Code	MSRP USD	004 IA	010 PA	014 CA	016 NC	EXP N
	FMSGNC-60 60" Non-Combustible Cove Gray HTI 1 \$ 1,209	14	Y	21	14	N		

Non-Combustible Cove Gray 72"

		Disc. Code	MSRP USD	004 IA	010 PA	014 CA	016 NC	EXP N
	FMSGNC-72 72" Non-combustible Cove Gray HTI 1 \$ 1,359	14	Y	21	14	N		

Non-Combustible Midnight Mist 60"

		Disc. Code	MSRP USD	004 IA	010 PA	014 CA	016 NC	EXP N
	FMMMNC-60 60" Non-combustible Midnight Mist HTI 1 \$ 1,359	14	Y	21	14	N		

Non-Combustible Midnight Mist 72"

		Disc. Code	MSRP USD	004 IA	010 PA	014 CA	016 NC	EXP N
	FMMMNC-72 72" Non-combustible Midnight Mist HTI 1 \$ 1,509	14	Y	21	14	N		

Non-Combustible Tavern Brown 60"



		Disc. Code	MSRP USD	004 IA	010 PA	014 CA	016 NC	EXP
FMTBNC-60	60" Non-Combustible Tavern Brown	HTI 1	\$ 1,309	14	Y	21	14	N

Non-Combustible Tavern Brown 72"



		Disc. Code	MSRP USD	004 IA	010 PA	014 CA	016 NC	EXP
FMTBNC-72	72" Non-Combustible Tavern Brown	HTI 1	\$ 1,459	14	Y	21	21	N

Non-Combustible Washed Cedar 60"



		Disc. Code	MSRP USD	004 IA	010 PA	014 CA	016 NC	EXP
FMWCNC-60	60" Non-Combustible Washed Cedar	HTI 1	\$ 1,259	14	Y	21	14	N

Non-Combustible Washed Cedar 72"



		Disc. Code	MSRP USD	004 IA	010 PA	014 CA	016 NC	EXP
FMWCNC-72	72" Non-Combustible Washed Cedar	HTI 1	\$ 1,409	14	Y	21	14	N

Non-Combustible Weathered Barnwood 60"



		Disc. Code	MSRP USD	004 IA	010 PA	014 CA	016 NC	EXP
FMWBNC-60	60" Non-Combustible Barnwood	HTI 1	\$ 1,459	14	Y	21	14	N

Non-Combustible Weathered Barnwood 72"



		Disc. Code	MSRP USD	004 IA	010 PA	014 CA	016 NC	EXP
FMWBNC-72	72" Non-Combustible Barnwood	HTI 1	\$ 1,679	14	Y	14	14	N

Non-Combustible White 60"



		Disc. Code	MSRP USD	004 IA	010 PA	014 CA	016 NC	EXP
FMWHNC-60	60" Non-Combustible White	HTI 1	\$ 1,209	21	Y	21	21	N

Non-Combustible White 72"



		Disc. Code	MSRP USD	004 IA	010 PA	014 CA	016 NC	EXP
FMWHNC-72	72" Non-Combustible White	HTI 1	\$ 1,359	14	Y	21	14	N

<h1>Hearth & Home Technologies</h1>	<h2>Samples - Wood Shelf Mantel</h2>	Stocked Item/Lead Time 004=Mt. Pleasant RDC 010=Kutztown RDC 014=Sacramento RDC 016=Charlotte RDC EXP=Factory Expedite Program
		Prices in USD Non-stock and custom product cannot be cancelled. Customer is responsible for freight for orders made outside of assigned RDC facility.

Page printed 2/1/2024 3:05:35 PM CST
 * Please Contact Who You Purchase This Through for MSRP Pricing

Baxter Shelf Sample

		Disc.	MSRP						
		Code	USD						
					004	010	014	016	EXP
FMBRMPY	Baxter Shelf Sample, Primed MDF	HTI 1	\$ 107	21	Y	21	21	Y	
FMBRAUY	Baxter Shelf Sample, Unfinished Maple	HTI 1	\$ 137	28	21	28	28	N	

Crosby Shelf Sample

		Disc.	MSRP						
		Code	USD						
				004	010	014	016	EXP	
FMCYMPY	Crosby Shelf Sample, Primed MDF	HTI 1	\$ 107	21	Y	21	21	Y	
FMCYAUY	Crosby Shelf Sample, Unfinished Maple	HTI 1	\$ 137	28	21	28	28	N	

Fillmore Shelf Sample

		Disc.	MSRP						
		Code	USD						
					004	010	014	016	EXP
FMFEMPY	FILLMORE SHELF SAMPLE	HTI null	\$ 107	21	Y	21	21	N	

Ozark Shelf Sample

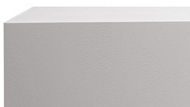
		Disc.	MSRP						
		Code	USD						
					004	010	014	016	EXP
FMOKMPY	OZARK SHELF SAMPLE	HTI null	\$ 107	21	Y	21	21	N	

Hearth & Home Technologies

Marble, Granite & Slate

Stocked Item/Lead Time

004=Mt. Pleasant RDC
010=Kutztown RDC
014=Sacramento RDC
016=Charlotte RDC

EXP=Factory Expedite Program

Page printed 2/1/2024 3:05:35 PM CST

* Please Contact Who You Purchase This Through for MSRP Pricing

Prices in USD

Non-stock and custom product cannot be cancelled.

Customer is responsible for freight for orders made outside of assigned RDC facility.

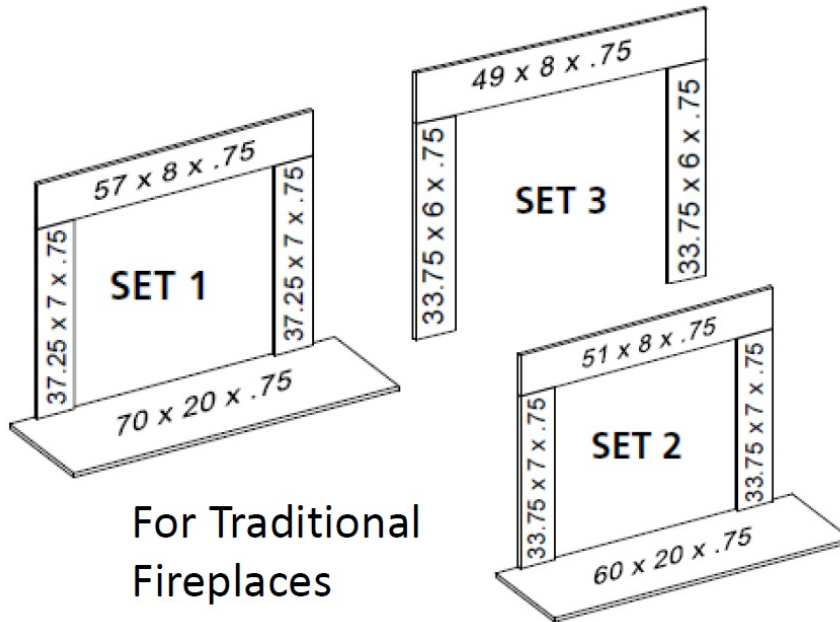

For Traditional Fireplaces

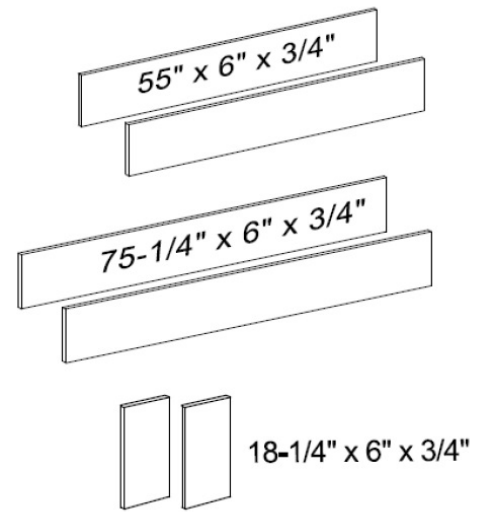

For Linear Fireplaces

Absolute Black Granite Set 1

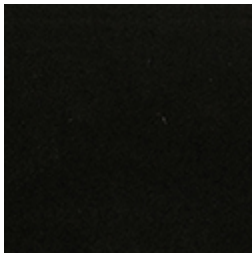

		Disc. Code	MSRP USD	004 IA	010 PA	014 CA	016 NC	EXP
MBBGMS1	Absolute Black granite, Set 1 (must order in multiples of 6)	HTI 1	\$ 939	Y	Y	14	Y	N
MBBGMS1PK1	Absolute Black granite, Set 1, single pack	HTI 1	\$ 1,369	21	7	21	21	N

Absolute Black Granite Set 2

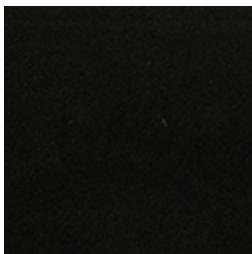

		Disc. Code	MSRP USD	004 IA	010 PA	014 CA	016 NC	EXP
MBBGMS2	Absolute Black granite, Set 2 (must order in multiples of 6)	HTI 1	\$ 879	Y	Y	14	Y	N
MBBGMS2PK1	Absolute Black granite, Set 2, single pack	HTI 1	\$ 1,299	21	7	14	21	N

Absolute Black Set 3



		Disc. Code	MSRP USD	004 IA	010 PA	014 CA	016 NC	EXP
MBBGMS3	BLACK GRANITE SET 3 MPK-6	HTI 1	\$ 579	21	Y	21	Y	N
MBBGMS3PK1	BLACK GRANITE SET 3 SPK	HTI 1	\$ 1,009	21	7	21	21	N

Beige Marble Set 1



		Disc. Code	MSRP USD	004 IA	010 PA	014 CA	016 NC	EXP
MBBEEMS1	BEIGE SET 1 MPK-6	HTI 1	\$ 1,059	21	Y	21	Y	N
MBBEEMS1PK1	BEIGE SET SPK	HTI 1	\$ 1,469	21	7	21	21	N

Beige Marble Set 2



		Disc. Code	MSRP USD	004 IA	010 PA	014 CA	016 NC	EXP
MBBEEMS2	BEIGE SET 2 MPK-6	HTI 1	\$ 999	21	Y	21	Y	N
MBBEEMS2PK1	BEIGE SET 2 SPK	HTI 1	\$ 1,409	21	14	21	21	N

Beige set 3



		Disc. Code	MSRP USD	004 IA	010 PA	014 CA	016 NC	EXP
MBBEEMS3	Beige Set 3, (must be ordered in multiples of 6)	HTI 1	\$ 669	21	Y	21	21	N
MBBEEMS3PK1	Beige Set 3, single pack	HTI 1	\$ 1,079	21	7	21	21	N

Bianco White set 1

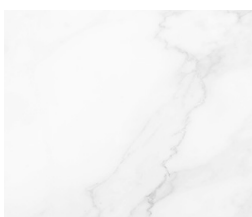

		Disc. Code	MSRP USD	004 IA	010 PA	014 CA	016 NC	EXP
MBBVMS1	Bianco White Marble, Set 1 (Must order in multiples of 6)	HTI 1	\$ 939	Y	Y	21	Y	N
MBBVMS1PK1	Bianco White Marble, Set 1, single pack	HTI 1	\$ 1,369	21	14	21	21	N

Bianco White set 2



		Disc. Code	MSRP USD	004 IA	010 PA	014 CA	016 NC	EXP
MBBVMS2	Bianco White Marble, Set 2 (Must order in multiples of 6)	HTI 1	\$ 879	21	Y	28	Y	N
MBBVMS2PK1	Bianco White Marble, Set 2, single pack	HTI 1	\$ 1,299	21	21	28	21	N

Bianco White set 3



		Disc. Code	MSRP USD	004 IA	010 PA	014 CA	016 NC	EXP
MBBVMS3	Bianco White Marble, Set 3 (must order 6)	HTI 1	\$ 579	21	Y	14	Y	N
MBBVMS3PK1	Bianco White Marble, Set 3, single pack	HTI 1	\$ 1,009	21	21	21	21	N

Blue Tundra set 1



		Disc. Code	MSRP USD	004 IA	010 PA	014 CA	016 NC	EXP
MBBTAMS1	Blue Tundra Marble, Set 1 (must be ordered in multiples of 6)	HTI 1	\$ 1,059	28	Y	28	Y	N
MBBTAMS1PK1	Blue Tundra Marble, Set 1, single pack	HTI 1	\$ 1,469	28	28	28	35	N

Blue Tundra set 2



		Disc. Code	MSRP USD	004 IA	010 PA	014 CA	016 NC	EXP
MBBTAMS2	Blue Tundra Marble, Set 2 (must be ordered in multiples of 6)	HTI 1	\$ 999	14	Y	21	Y	N
MBBTAMS2PK1	Blue Tundra Marble, Set 2, single pack	HTI 1	\$ 1,409	21	21	21	21	N

Blue Tundra set 3



		Disc. Code	MSRP USD	004 IA	010 PA	014 CA	016 NC	EXP
MBBTAMS3	Blue Tundra marble, Set 3 (must be ordered in multiples of 6)	HTI 1	\$ 669	14	Y	21	14	N
MBBTAMS3PK1	Blue Tundra marble, Set 3, single pack	HTI 1	\$ 1,079	14	28	21	21	N

Driftwood 55 x 6 Linear Header, Riser



	Disc. Code	MSRP USD	004	010	014	016	EXP
			IA	PA	CA	NC	
MBDD55X6	Driftwood Marble, one header, one riser, 55 x 6 x HTI 1 .75	\$ 319	21	Y	21	21	N

Driftwood 75.25 x 6 Linear Header, riser



	Disc. Code	MSRP USD	004	010	014	016	EXP
			IA	PA	CA	NC	
MBDD7525X6	Driftwood Marble, one header, one riser, 75.25 x HTI 1 6 x .75	\$ 459	21	Y	21	21	N

Driftwood Linear Legs (2)



	Disc. Code	MSRP USD	004	010	014	016	EXP
			IA	PA	CA	NC	
MBDD1825X6	Driftwood Marble, two legs, 18.25 x 6 x .75	HTI 1 \$ 76	21	Y	21	21	N

Driftwood set 1



	Disc. Code	MSRP USD	004	010	014	016	EXP
			IA	PA	CA	NC	
MBDDMS1	Driftwood Marble, Set 1 (must be ordered in multiples of 6)	HTI 1 \$ 939	21	Y	21	Y	N
MBDDMS1PK1	Driftwood Marble, Set 1, single pack	HTI 1 \$ 1,369	21	21	21	28	N

Driftwood set 2



	Disc. Code	MSRP USD	004	010	014	016	EXP
			IA	PA	CA	NC	
MBDDMS2	Driftwood Marble, Set 2 (must be ordered in multiples of 6)	HTI 1 \$ 879	21	Y	14	Y	N
MBDDMS2PK1	Driftwood Marble, Set 2, single pack	HTI 1 \$ 1,299	14	66	21	21	N

Driftwood set 3



		Disc. Code	MSRP USD	004 IA	010 PA	014 CA	016 NC	EXP
MBDDMS3	Driftwood marble, Set 3 (must be ordered in multiples of 6)	HTI 1	\$ 579	21	Y	21	35	N
MBDDMS3PK1	Driftwood marble, Set 3 single pack	HTI 1	\$ 1,009	21	21	21	28	N

New Venetian Granite Set 1

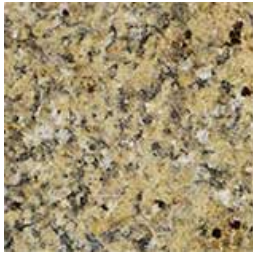

		Disc. Code	MSRP USD	004 IA	010 PA	014 CA	016 NC	EXP
MBOGMS1	New Venetian Granite, Set 1 (must order in multiples of 6)	HTI 1	\$ 769	21	Y	21	Y	N
MBOGMS1PK1	New Venetian Granite, Set 1, Single-pack	HTI 1	\$ 1,219	21	7	14	21	N

New Venetian Granite Set 2



		Disc. Code	MSRP USD	004 IA	010 PA	014 CA	016 NC	EXP
MBOGMS2	New Venetian Granite, Set 2 (must order in multiples of 6)	HTI 1	\$ 719	21	Y	28	Y	N
MBOGMS2PK1	New Venetian Granite, Set 2, Single-pack	HTI 1	\$ 1,169	21	14	28	21	N

New Venetian set 3

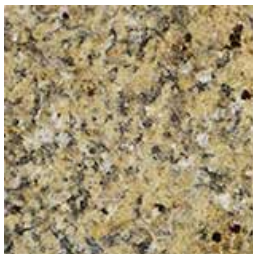

		Disc. Code	MSRP USD	004 IA	010 PA	014 CA	016 NC	EXP
MBOGMS3	New Venetian Granite, Set 3 (must be ordered in multiples of 6)	HTI 1	\$ 459	21	14	21	21	N
MBOGMS3PK1	New Venetian Granite, Set 3, Single Pack	HTI 1	\$ 889	21	7	21	21	N

Parchwood set 1



		Disc. Code	MSRP USD	004 IA	010 PA	014 CA	016 NC	EXP
MBPDMS1	Parchwood Marble, Set 1 (must be ordered in multiples of 6)	HTI 1	\$ 939	21	Y	21	Y	N
MBPDMS1PK1	Parchwood Marble, Set 1, single pack	HTI 1	\$ 1,369	21	21	21	28	N

Parchwood set 2



		Disc. Code	MSRP USD	004 IA	010 PA	014 CA	016 NC	EXP
MBPDMS2	Parchwood Marble, Set 2 (must be ordered in multiples of 6)	HTI 1	\$ 879	Y	Y	21	Y	N
MBPDMS2PK1	Parchwood Marble, Set 2, single pack	HTI 1	\$ 1,299	21	7	21	21	N

Parchwood set 3



		Disc. Code	MSRP USD	004 IA	010 PA	014 CA	016 NC	EXP
MBPDMS3	Parchwood marble, Set 3 (must be ordered in multiples of 6)	HTI 1	\$ 579	21	Y	21	21	N
MBPDMS3PK1	Parchwood marble, Set 3, single pack	HTI 1	\$ 1,009	21	7	14	21	N

Pauline Granite Set 1



		Disc. Code	MSRP USD	004 IA	010 PA	014 CA	016 NC	EXP
MBPEMS1	Pauline Granite, Set 1 (must be ordered in multiples of 6)	HTI 1	\$ 769	21	Y	21	21	N
MBPEMS1PK1	Pauline Granite, Set 1, single pack	HTI 1	\$ 1,219	21	7	21	21	N

Pauline Granite Set 2



		Disc. Code	MSRP USD	004 IA	010 PA	014 CA	016 NC	EXP
MBPEMS2	Pauline Granite, Set 2 (must order in multiples of 6)	HTI 1	\$ 719	Y	Y	21	Y	N
MBPEMS2PK1	Pauline Granite, Set 2, single pack	HTI 1	\$ 1,169	21	7	21	21	N

Pauline Granite Set 3



		Disc. Code	MSRP USD	004 IA	010 PA	014 CA	016 NC	EXP
MBPEMS3	Pauline granite, Set 3 (must order in multiples of 6)	HTI 1	\$ 459	21	Y	21	21	N
MBPEMS3PK1	Pauline granite, Set 3, single pack	HTI 1	\$ 889	21	7	21	21	N

Slate 37.25X7



	Disc. Code	MSRP USD	004	010	014	016	EXP
			IA	PA	CA	NC	
MBSR3725X7-C	HTI 1	\$ 76	63	Y	63	Y	N
Slate Legs 37.25X7X5/8 (must be ordered in multiples of 50)							

Slate 51X8

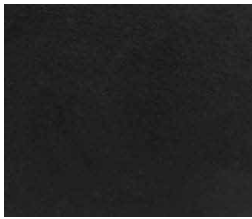

	Disc. Code	MSRP USD	004	010	014	016	EXP
			IA	PA	CA	NC	
MBSR51X8-C	HTI 1	\$ 139	63	Y	63	Y	N
Slate Header 51X8X5/8 (must be ordered in multiples of 25)							

Slate 57X8

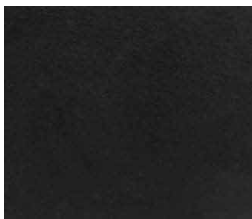

	Disc. Code	MSRP USD	004	010	014	016	EXP
			IA	PA	CA	NC	
MBSR57X8-C	HTI 1	\$ 139	70	Y	70	Y	N
Slate Header 57X8X5/8 (must be ordered in multiples of 25)							

Slate 60X20



	Disc. Code	MSRP USD	004	010	014	016	EXP
			IA	PA	CA	NC	
MBSR60X20-C	HTI 1	\$ 329	63	Y	63	Y	N
Slate Hearth 60X20X5/8 (must be ordered in multiples of 25)							

Slate 70x20"

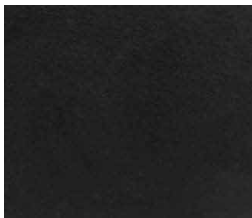

	Disc. Code	MSRP USD	004	010	014	016	EXP
			IA	PA	CA	NC	
MBSR70X20-C	HTI 1	\$ 409	70	Y	70	Y	N
Slate Hearth 70X20X5/8 (must be ordered in multiples of 25)							

Steel Gray Granite set 1

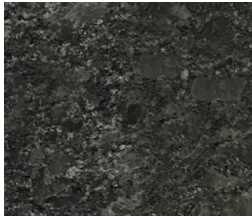

		Disc. Code	MSRP USD	004 IA	010 PA	014 CA	016 NC	EXP
MBSGMS1	Steel Gray granite, Set 1 (must order in multiples of 6)	HTI 1	\$ 939	Y	Y	21	Y	N
MBSGMS1PK1	Steel Gray granite, Set 1, single pack	HTI 1	\$ 1,369	21	28	21	21	N

Steel Gray set 2



		Disc. Code	MSRP USD	004 IA	010 PA	014 CA	016 NC	EXP
MBSGMS2	Steel Gray granite, Set 2 (must order in multiples of 6)	HTI 1	\$ 879	21	Y	14	Y	N
MBSGMS2PK1	Steel Gray granite, Set 2, single pack	HTI 1	\$ 1,299	21	7	14	21	N

Steel Gray set 3

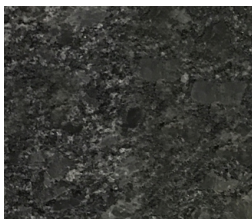

		Disc. Code	MSRP USD	004 IA	010 PA	014 CA	016 NC	EXP
MBSGMS3	Steel Gray Granite, Set 3 (must be ordered in multiples of 6)	HTI 1	\$ 579	21	Y	21	21	N
MBSGMS3PK1	Steel Gray Granite, Set 3, single pack	HTI 1	\$ 1,009	21	7	21	21	N

Thala Beige set 1



		Disc. Code	MSRP USD	004 IA	010 PA	014 CA	016 NC	EXP
MBTEMS1	Thala Beige, Set 1 (must be ordered in multiples of 6)	HTI 1	\$ 1,059	21	Y	21	21	N
MBTEMS1PK1	Thala Beige, Set 1, single pack	HTI 1	\$ 1,469	21	7	21	21	N

Thala Beige set 2



		Disc. Code	MSRP USD	004 IA	010 PA	014 CA	016 NC	EXP
MBTEMS2	Thala Beige Marble, Set 2 (must be ordered in multiples of 6)	HTI 1	\$ 999	Y	Y	21	Y	N
MBTEMS2PK1	Thala Beige Marble, Set 2, single pack	HTI 1	\$ 1,409	21	7	21	21	N

Thala Beige set 3



		Disc. Code	MSRP USD	004 IA	010 PA	014 CA	016 NC	EXP
MBTEMS3	Thala Beige, Set 3 (must be ordered in multiples of 6)	HTI 1	\$ 669	21	Y	21	21	N
MBTEMS3PK1	Thala Beige, Set 3, single pack	HTI 1	\$ 1,079	21	7	21	21	N

Majestic - Fireside Finishings Recommended Mantel, Cabinet and Surround Reference Sheet

Recommendations based on clearance to combustibles listed in installation instructions. If space is left blank, there are no mantel recommendations at this time.

* NOTE: Hearth must be cut to fit between legs of mantel or recessed to be flush with the floor. Marble set sizes are minimum size required to fit. Larger sets may be used depending on desired look. Additional cuts may be required.

This sheet is intended to be used as a quick reference guide only. Use the HHT Natural Stone Sizing Guide for specific details on dimensions to cut legs/hearths.

Unit Series	HHT Brand	Mantel	SELECT			SIGNATURE					DESIGN				SHELVE S	Minimum combustible mantel clearances measured from top of firebox opening				
			Richland	Richland RS	Wescott	Acadia	Kenwood	Kenwood B60	Merritt	Roxborough	Zimmer	Battlefield	Laurel	Malone		Walker	Baxter, Crosby, Fillmore, Ozark	3" Mantel Depth	5" Mantel Depth	7" Mantel Depth
ASH36	MAJ	Mantel Size													48", 59"					22
		NS Set Size																		
ASH42	MAJ	Mantel Size													59", 72"					
		NS Set Size																		
ASH50	MAJ	Mantel Size													59", 72"					
		NS Set Size																		
BE36	MAJ	Mantel Size	B		B	B	B	B	B	B	B	B	B	B	48", 59"					
		NS Set Size	2		2	1	1	2	1	2	1	1	1	1		1				
BE42	MAJ	Mantel Size	C		C	C		C	C	C					59", 72"					
		NS Set Size	1		1	1		1	1	1										
Biltmore 36	MAJ	Mantel Size													48", 59"					
		NS Set Size																		
Biltmore 42	MAJ	Mantel Size													59", 72"					
		NS Set Size																		
Biltmore 50	MAJ	Mantel Size													59", 72"					
		NS Set Size																		
DSR36	MAJ	Mantel Size	B		B	B	B	B	B	B	B	B	B	B	48", 59"					
		NS Set Size	2		2	1	1	2	1	2	1	1	1	1		1				
DSR42	MAJ	Mantel Size	C		C	C		C	C	C					59", 72"					
		NS Set Size	1		1	1		1	1	1										
Echelon II 36 & 36ST	MAJ	Mantel Size													48", 59"	20"	22"	24"	25"	29"
		NS Set Size	MBDD55X6 header & riser; MBDD1825X6 legs																	
Echelon II 48 & 42ST	MAJ	Mantel Size													59", 72"	20"	22"	24"	25"	29"
		NS Set Size	MBDD7525X6 header & riser; MBDD1825X6 legs																	
Echelon II 60	MAJ	Mantel Size													72"	24"	26"	28"	29"	
		NS Set Size	MBDD7525X6 header & riser; MBDD1825X6 legs																	
Echelon II 72	MAJ	Mantel Size														24"	26"	28"	29"	
		NS Set Size																		

Majestic - Fireside Finishings Recommended Mantel, Cabinet and Surround Reference Sheet

Recommendations based on clearance to combustibles listed in installation instructions. If space is left blank, there are no mantel recommendations at this time.

* NOTE: Hearth must be cut to fit between legs of mantel or recessed to be flush with the floor. Marble set sizes are minimum size required to fit. Larger sets may be used depending on desired look. Additional cuts may be required.

This sheet is intended to be used as a quick reference guide only. Use the HHT Natural Stone Sizing Guide for specific details on dimensions to cut legs/hearths.

Unit Series	HHT Brand	Mantel	SELECT			SIGNATURE					DESIGN				SHELVES Baxter, Crosby, Filmore, Ozark	Minimum combustible mantel clearances measured from top of firebox opening				
			Richland	Richland RS	Wescott	Acadia	Kenwood	Kenwood B&O	Merritt	Roxborough	Zimmer	Battlefield	Laurel	Malone		Walker	3" Mantel Depth	5" Mantel Depth	7" Mantel Depth	8" Mantel Depth
Jade 32	MAJ	Mantel Size													48", 59"					14"
		NS Set Size	MBDD55X6 header & riser; MBDD1825X6 legs																	
Jade 42	MAJ	Mantel Size													48", 59", 72"					14"
		NS Set Size	MBDD55X6 header & riser; MBDD1825X6 legs																	
MARQUIS II 36	MAJ	Mantel Size													48", 59"	15"	17"	20"	21"	24"
		NS Set Size																		
MARQUIS II 42	MAJ	Mantel Size													59", 72"	15"	17"	20"	21"	24"
		NS Set Size																		
MARQUIS II 42ST	MAJ	Mantel Size													59", 72"	10"	10"	10"	10"	10"
		NS Set Size																		
Mercury (MERC32)	MAJ	Mantel Size	A		A	A	A			A	A				48"	4"	6"	8"	9"	13"
		NS Set Size	3*		3*	3*	3*			3*	3*									
Meridian 36 (DBDV36)	MAJ	Mantel Size	B		B	B	B	B	B	B	B	B	B	B	48", 59"	10"	12"	14"	15"	19"
		NS Set Size	2		2	1	1	2	1	2	1	1	1	1						
Meridian 42 (DBDV42)	MAJ	Mantel Size	C		C	C	C		C	C	C	C	C	C	59", 72"	10"	12"	14"	15"	19"
		NS Set Size	1		1	1	1		1	1	1	1	1	1						
Meridian Platinum 36 (DBDV36PLAT)	MAJ	Mantel Size	B		B	B	B	B	B	B	B	B	B	B	48", 59"	10"	12"	14"	15"	19"
		NS Set Size	2		2	1	1	2	1	2	1	1	1	1						
Meridian Platinum 42 (DBDV42PLAT)	MAJ	Mantel Size	C		C	C	C		C	C	C	C	C	C	59", 72"	10"	12"	14"	15"	19"
		NS Set Size	1		1	1	1		1	1	1	1	1	1						
Pearl II Peninsula 36	MAJ	Mantel Size													48", 59"	10"	12"	14"	15"	19"
		NS Set Size																		
Pearl II See-through 36	MAJ	Mantel Size	B		B	B	B	B	B	B	B	B	B	B	48", 59"	10"	12"	14"	15"	19"
		NS Set Size	2		2	1	1	2	1	2	1	1	1	1						

Majestic - Fireside Finishings Recommended Mantel, Cabinet and Surround Reference Sheet

Recommendations based on clearance to combustibles listed in installation instructions. If space is left blank, there are no mantel recommendations at this time.

* NOTE: Hearth must be cut to fit between legs of mantel or recessed to be flush with the floor. Marble set sizes are minimum size required to fit. Larger sets may be used depending on desired look. Additional cuts may be required.

This sheet is intended to be used as a quick reference guide only. Use the HHT Natural Stone Sizing Guide for specific details on dimensions to cut legs/hearths.

Unit Series	HHT Brand	Mantel	SELECT			SIGNATURE						DESIGN				SHELVES	Minimum combustible mantel clearances measured from top of firebox opening				
			Richland	Richland RS	Wescott	Acadia	Kenwood	Kenwood B60	Merritt	Roxborough	Zimmer	Battlefield	Laurel	Malone	Walker		Baxter, Crosby, Fillmore, Ozark	3" Mantel Depth	5" Mantel Depth	7" Mantel Depth	8" Mantel Depth
QUARTZ 32	MAJ	Mantel Size	A	RS	A	A	A			A						48"	4"	6"	8"	9"	13"
		NS Set Size	3*	1	3*	3*	3*			3*											
QUARTZ 36	MAJ	Mantel Size	B		B	B	B	B	B	B	B	B	B	B	B	48", 59"	4"	6"	8"	9"	13"
		NS Set Size	2		2	1	1	2	1	2	1	1	1	1	1						
QUARTZ 42	MAJ	Mantel Size	C		C	C	C		C	C	C	C	C	C	59", 72"	4"	6"	8"	9"	13"	
		NS Set Size	1		1	1	1		1	1	1	1	1	1							
RBV4236	MAJ	Mantel Size	B		B	B	B	B	B	B	B	B	B	B	59", 72"	6 1/2"	9 1/4"	10 3/4"	11 1/2"	14 1/2"	
		NS Set Size	2		2	1	1	2	1	2	1	1	1	1							
RBV4842	MAJ	Mantel Size	C		C	C	C		C	C	C	C	C	C	59", 72"	6 1/2"	9 1/4"	10 3/4"	11 1/2"	14 1/2"	
		NS Set Size	1		1	1	1		1	1	1	1	1	1							
SA36	MAJ	Mantel Size	B		B	B	B	B	B	B	B	B	B	B	48", 59"					12	
		NS Set Size	2		2	1	1	2	1	2	1	1	1	1							
SA42	MAJ	Mantel Size	C		C	C	C		C	C	C	C	C	C	59", 72"					12	
		NS Set Size	1		1	1	1		1	1	1	1	1	1							