



SUMMERSET

2024 CATALOG





LET'S GRILL.

FEATURED

- 42" ALTURI GRILL
- ALTURI DOUBLE SIDE BURNER
- 24" 4.5 Cu. DELUXE OUTDOOR RATED DUAL ZONE WINE COOLER
- 32" FARMHOUSE SINK
- 36" DOUBLE ACCESS DOOR

COVER

- 42" QUEST
- 24" DUAL ZONE WINE COOLER
- 48" VENT HOOD

Grills

Summerset Grills offers a complete line of commercial grade stainless steel barbecue grills. Whether you're looking for a simple, clean, entry-level grill like the Sizzler, or an entirely Made-in-America, luxury appliance like the Alturi, we have it all.

FEATURED

- 38" TRL GRILL
- 15" 3.2 Cu. OUTDOOR RATED REFRIGERATOR
- 36" 2-DRAWER & ACCESS DOOR COMBO







ALTURI 30" / 36" / 42"

ALT30 / ALT36 / ALT42

The Alturi Series can be summed up in one word: luxury. Designed with elegance, made in the U.S., fueled with power, and loaded with every feature, this grill sets the bar for luxury outdoor cooking.



#304 Stainless Steel Construction



26,000 BTU #304 Stainless Steel U-Tube Burners



Double-Lined Hood w/ Spring Assist



12,000 BTU IR Back Burner



Heavy-Duty 9mm Cooking Grates



Interior and Exterior Lighting

ADDITIONAL FEATURES



PROUDLY MADE
IN THE USA

- Interior Halogen Lighting
- Exterior LED Front Panel Lighting
- Heat Zone Separators
- Easy-Clean Briquette System
- Flame Thrower Ignition
- Manual Flash Tube Ignition
- 40 lb. Motor with Rotisserie Kit Included
- 26,000 BTU Drop-In Sear Burner Available
- LED Lighted Double Side Burner, Sear Side Burner & Power Burner Available
- Red Brass Burners Available
- Grill Cover Included
- Built-In & Cart Models Available
- Grill Liner Available
- Built, Factory-Tested, & Serviced in the USA
- Natural Gas (NG) & Propane (LP) Available
- Gold Standard Lifetime Warranty



NEW PRODUCT!

QUEST 30" / 36" / 42"

QST30 / QST36 / QST42

Dare to adventure with the all-new Quest Grill! Quest brings a new era of outdoor grilling with premium features, innovative accessories, and unmatched quality. Quest is not just a grill; it's an experience, a flavorful adventure waiting to unfold in your backyard.



#304 Stainless Steel Construction



Electronic Flame Thrower Ignition



Interior Halogen Cooking Lights



Exterior LED Strip Lighting + White to Red Bezel Lighting Indicating On/Off Burner State



18,000 BTU U-Tube Burners



Multi-Position Warming Racks (QST30/36 x2 / QST42 x3)

ADDITIONAL FEATURES

- Interior Halogen Lighting
- Heat Zone Separators
- Easy-Clean Briquette System
- Flame Thrower Ignition
- Manual Flash Tube Ignition
- Rotisserie Kit with 40 lb. Motor Included
- 18,000 BTU Drop-In Sear Burner Available
- Heavy-Duty 8mm Square Cooking Grates
- Waterfall LED Strip Over Knobs
- 10,500 BTU Angled Infrared Rear Burner
- Rear Burner Flame-Out System Will Stop Gas Supply if Flame is Not Detected
- 18-Gauge Double-Lined Hood w/ Spring Assist
- #304 Stainless Steel Full-Width Hood Handle
- Removable, Dishwasher Safe Drip Tray
- Rib Rack Included
- Smoker Box Included
- Drop-In Griddle Plate Included
- Warming Rack Storage in Full-Width Drip Tray
- Weatherproof Vinyl Grill Head Cover Included
- Natural Gas (NG) & Propane (LP) Available
- Gold Standard Lifetime Warranty

*IMAGE SHOWN WITH BURNERS TURNED "ON"





TRL/TRLD 32" / 38" / 44"

TRL32 / TRL38 / TRLD44

The TRL is a fully loaded workhorse, a grilling classic packed with luxury features. Complete with interior lights, exterior LEDs, rear infrared burner, rotisserie kit, flame thrower valves, easy-clean briquette burner covers, and plug-and-play infrared sear zone options, the TRL makes professional grilling easy.



#304 Stainless Steel Construction



18,000 BTU #304 Stainless U-Tube Burners



16 & 18 Gauge Double-Lined Hood



15,000 BTU IR Back Burner



8mm Cooking Grates and Easy-Clean Briquette System



Interior and Exterior Lighting

ADDITIONAL FEATURES

- Interior Halogen Lighting
- Exterior LED Front Panel Lighting
- Heat Zone Separators
- Easy-Clean Briquette System
- Flame Thrower Ignition
- Manual Flash Tube Ignition
- 40 lb. Motor with Rotisserie Kit Included
- 18,000 BTU Drop-In Sear Burner Available
- LED Lighted Double Side Burner & Power Burner Available
- Natural Gas (NG) & Propane (LP) Available
- Built-In & Cart Models Available
- Cast Stainless Burners Available
- Grill Liner Available
- Grill Cover Available
- Gold Standard Lifetime Warranty

TRLD ADDED FEATURES

- Cast Stainless Burners
- Heavy-Duty 9mm Cooking Grates





SIZZLER PRO 32" / 40"

SIZPRO32 / SIZPRO40

The Sizzler Pro Series combines features, quality construction, and affordability. Based on the same sleek design of our classic Sizzler, with the addition of interior and exterior lighting, 14,000 BTU cast burners and heatzone separators, this grill really sets itself apart.



#443 Commercial Grade Stainless Steel



18-Gauge Double-Lined Hood



8mm Cooking Grates and Easy-Clean Briquette System



14,000 BTU Cast Stainless Burners



15,000 BTU IR Back Burner



Interior and Exterior Lighting

ADDITIONAL FEATURES

- Interior Halogen Lighting
- Exterior LED Front Panel Lighting
- Heat Zone Separators
- Easy-Clean Briquette System
- Flame Thrower Ignition
- Manual Flash Tube Ignition
- 40 lb. Motor with Rotisserie Kit Available
- LED Lighted Double Side Burner & Power Burner Available
- Side Burner Cart Bracket Available
- Built-In & Cart Models Available
- Natural Gas (NG) & Propane (LP) Available
- Grill Liner Available
- Grill Cover Available
- 14,000 BTU Drop-In Sear Burner Available
- Gold Standard Lifetime Warranty





SIZZLER 26" / 32" / 40"

SIZ26 / SIZ32 / SIZ40

The Summerset Sizzler Series is a premium product at an unbeatable price. Constructed in all #443 stainless steel and designed with careful precision to ensure optimal airflow and even heating, this grill gives its higher-priced competitors a run for their money in both durability and grilling performance. The Sizzler will impress the most discriminating of grillers.



#443 Commercial Grade Stainless Steel



12,000 BTU #304 Stainless Tube Burners



18-Gauge Double-Lined Hood



15,000 BTU IR Back Burner (32" & 40" Only)



8mm Stainless Steel Cooking Grates & Easy-Clean Briquette System



Interior and Exterior Lighting

ADDITIONAL FEATURES

- Easy-Clean Briquette System
- Flame Thrower Ignition
- Manual Flash Tube Ignition
- 40 lb. Motor with Rotisserie Kit Available
- Matching Double Side Burner Available
- Side Burner Cart Bracket Available
- Built-In & Cart Models Available
- 12,000 BTU Drop-In Sear Burner Available
- Cast Stainless Burners Available
- Grill Liner Available
- Grill Cover Available
- Natural Gas (NG) & Propane (LP) Available
- Gold Standard Lifetime Warranty





RESORT GRILL 30"

SBG30

The Resort Grill excels in performance while communicating quality and style to residents or clients. With optional features like LP conversion kits and timers, the Resort Grill can be configured for any commercial application.



PROUDLY MADE
IN THE USA



#304 Stainless Steel Construction



Flame Thrower Ignition



18-Gauge Double-Lined Hood



26,000 BTU #304 Stainless Steel U-Tube Burners



Heavy-Duty 9mm Cooking Grates



Heavy Duty Anti-Theft Knobs

ADDITIONAL FEATURES

- 26,000 BTU #304 Stainless Burners
- Heavy-Duty 14-Gauge Flame Tamers
- Locking Drip Tray
- Heavy-Duty Anti-Theft Knobs
- LP Conversion Kit Included
- Built, Factory Tested, and Serviced in the USA
- Built-In, Cart & Pedestal Models Available
- Gas Timers Available
- Grill Liner Available
- Grill Cover Available
- Gold Standard Lifetime Warranty



Gas Griddle Pro

Explore new flavors with the all-new, premium 30" Gas Griddle Pro by Summerset. Constructed of #304 stainless steel, this heavy-duty flat top grill is the perfect addition to your outdoor kitchen, diversifying your menu, and adding a host of new flavors.

- #304 Stainless Steel Construction
- 1/2" Thick Stainless Steel Cooking Surface
- 495 Sq. Inches of Cooking Surface
- 18,000 BTU Stainless Steel U-Tube Burners
- 36,000 Total BTU Output
- Included #304 Stainless Steel, Removable Lid
- Large Capacity Drip Tray
- Waterfall Exterior White LED Lighting



30" GAS GRIDDLE PRO
GRIDPRO-NG / LP



30" GAS GRIDDLE CART
CART-GRID30

- High-Power, Reliable Flame Thrower Ignition
- Grill Liner Available - GL-GRID30
- Overall Dimensions: 30" W x 28" D x 12" H
- Weight: 120 LB.
- CSA Certified
- Natural Gas (NG) & Propane (LP) Available
- Gold Standard Lifetime Warranty

Gas Griddle

Discover new flavors with Summerset's premium 30" Gas Griddle. Built with durable #304 stainless steel, this flat top grill enhances your outdoor kitchen. Ideal for steaks, burgers, eggs, and more!

- #304 Stainless Steel Construction
- 1/2" Thick Stainless Steel Cooking Surface
- 495 Sq. Inches of Cooking Surface
- 18,000 BTU Stainless Steel U-Tube Burners
- 36,000 Total BTU Output
- Included #304 Stainless Steel, Removable Lid
- Large Capacity Drip Tray
- Blue Exterior LED Lighting



30" GAS GRIDDLE
GRID30-NG / LP



30" GAS GRIDDLE CART
CART-GRID30

- High-Power, Reliable Flame Thrower Ignition
- Grill Liner Available - GL-GRID30
- Overall Dimensions: 30" W x 28" D x 12" H
- Weight: 120 LB
- Natural Gas (NG) & Propane (LP) Available.
- CSA Certified
- Gold Standard Lifetime Warranty

Hybrid Pizza Oven

Introducing the Hybrid Pizza Oven, where style and versatility abound. Whether you want the rich, smoky essence of wood-fired cooking or the exacting control and efficiency of gas, this oven brings both to the table with precision and, most importantly, flavor.



HYBRID PIZZA OVEN
OV-HYB-NG / LP

- Hybrid Oven, Ability to Cook with Wood or Gas
- 1- #304 Stainless Steel Tube L-Shaped Gas Burner
- 1- #304 Stainless Steel Jet Type Burner for Igniting Wood
- Gas Burner: 38,000 BTUs When Cooking with Gas Only
- Wood Burner Gas Starter Rated at 38,000 BTUs
- 390 Square Inches of Cooking Surface
- Stainless Steel Wood Rack + Ash Catch
- Temperature Up to 1022°F / 550°C
- Cooking Stone Made From Cordierite
- Digital Thermometer Measures Oven Ambient Temperature, Also Features Two (2) Meat Cooking Temperature Probes
- Material Interior: #443 Stainless Steel
- Stainless Steel Chimney
- Knobs for Burners Marked High/Low
- Adjustable Feet
- ETL Certified
- Gold Standard Lifetime Warranty

Outdoor Gas Oven

From appetizers to desserts, this oven will bake it all. Now you can add pizzas, roasts, brownies and more to your outdoor menu. To top it off, its #304 stainless steel construction is sure to outlast the competition.



OUTDOOR OVEN
SS-OVBI-NG / LP



OUTDOOR OVEN WITH CART
SS-OVFS-NG / LP

- Built-In Halogen Cooking Light
- Large Oven Capacity; Cook up to a 16-Inch Pizza
- Utensil Drawer
- Convenient Electronic Ignition
- Full View Front Window with Temperature Gauge
- Cool Touch, Heat Resistant Handle
- Flange Kit Available for Built-In Models
- CSA Certified
- Natural Gas (NG) & Propane (LP) Available
- Includes Deluxe Freestanding or Built-In Cover (GRILLCOV-OVBI / CARTCOV-OVFS)
- Gold Standard Lifetime Warranty

Side & Power Burners

Here we've combined the comfort of an indoor kitchen range with all the benefits of being outside. Specially designed for performance and function, a Summerset side burner is the perfect addition to your outdoor kitchen. Commonly used for finish cooking, sauces, or heating foods that require lower, more controlled temperatures than your grill, a side burner offers the convenience of range top cooking and grilling simultaneously.



ALTURI POWER BURNER
ALTPB2-NG / LP



ALTURI LIGHTED DOUBLE SIDE BURNER
ALTSB2-NG / LP



ALTURI LIGHTED SEAR SIDE BURNER
ALTSS-NG / LP



TRL LIGHTED POWER BURNER
TRLPB2-NG / LP



TRL LIGHTED DOUBLE SIDE BURNER
TRLSB2-NG / LP



SINGLE SIDE BURNER
SSSB1-NG / LP



SIZZLER PRO POWER BURNER
SIZPROPB-NG / LP

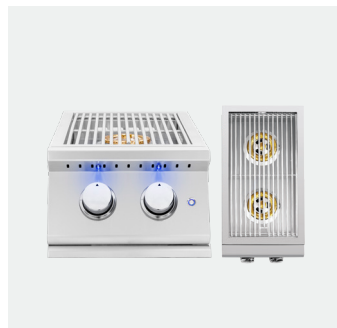

SIZZLER PRO LIGHTED DOUBLE SIDE BURNER
SIZPROSB2-NG / LP

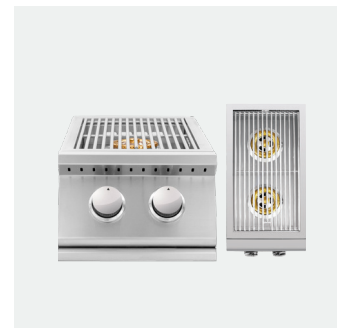

SIZZLER DOUBLE SIDE BURNER
SIZSB2-NG / LP

Freestanding Carts

Summerset Professional Grills' complete line of grill carts offer a premium alternative to built-in models. Constructed of the highest quality stainless steel and manufactured in the USA, Summerset's durable carts offers stability, storage and convenience for casual and professional chefs alike.



ALTURI 36" & 42" CART

CART-ALT36 / CART-ALT42

- #304 Stainless Steel
- Magnetic Access Door with 2-Drawer Storage
- Locking Caster Wheels
- Interior Door Condiment Tray
- Propane Tank Storage
- Side, Rear and Bottom Ventilation
- 30" Model Features Double Access Doors
- Fully Assembled
- Made in America



ALTURI 30" CART

CART-ALT30

- #304 Stainless Steel
- Magnetic Double Door Access
- Locking Caster Wheels
- Interior Door Condiment Tray
- Propane Tank Storage
- Side, Rear and Bottom Ventilation
- Fully Assembled
- Made in America



TRL DELUXE CART

CART-TRL32-DC / CART-TRL38-DC /
CART-TRLD44-DC

- #304 Stainless Steel
- Magnetic Access Door with 2-Drawer Storage
- Front Locking Caster Wheels
- Interior Paper Towel Holder
- Propane Tank Storage
- Side, Rear and Bottom Ventilation
- Fully Assembled
- Made in America



TRL CART

CART-TRL32 / CART-TRL38

- #304 Stainless Steel
- Magnetic Double Access Door
- Front Locking Caster Wheels
- Interior Paper Towel Holder
- Propane Tank Storage
- Side, Rear and Bottom Ventilation
- Made in America

FREESTANDING CARTS (CONT.)

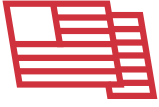

PROUDLY MADE
IN THE USA



SIZZLER DELUXE CART

CART-SIZ32-DC / CART-SIZ40-DC

- #304 Stainless Steel
- Magnetic Access Door with 2-Drawer Storage
- Front Locking Caster Wheels
- Interior Paper Towel Holder
- Propane Tank Storage
- Side, Rear and Bottom Ventilation
- Fully Assembled
- Made in America



SIZZLER CART

CART-SIZ26 / CART-SIZ32 / CART-40

- #304 Stainless Steel
- Magnetic Double Access Door
- Front Locking Caster Wheels
- Interior Paper Towel Holder
- Propane Tank Storage
- Side, Rear and Bottom Ventilation
- Made in America



RESORT CART

CART-ALT30

- #304 Stainless Steel
- Magnetic Double Door Access
- Locking Caster Wheels
- Interior Door Condiment Tray
- Propane Tank Storage
- Side, Rear and Bottom Ventilation
- Fully Assembled
- Made in America



RESORT PEDESTAL

SBG30-PED

- #304 Stainless Steel
- Locking Double Door
- Propane Tank Storage
- Side, Rear and Bottom Ventilation
- Fully Assembled
- Also Available with Wheels (CART-ALT30)
- Timer Available
- Made in America

22" REFRIGERATION SERIES

The 22" Compact Refrigerator Series offers 4.1 cubic feet of storage, #304 stainless steel doors, and automatic interior lighting. Build them into an island or use them inside—these refrigerators will add a whole new level of convenience to your setup.

NEW PRODUCT!

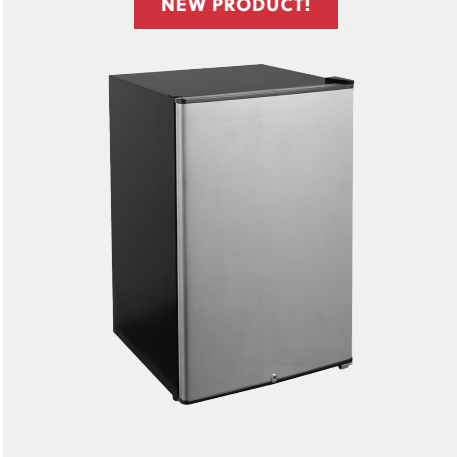

22" 4.1 Cu. OUTDOOR APPROVED COMPACT REFRIGERATOR

RFR-22S

- #304 Stainless Steel Reversible Door
- Upgrade Deluxe #304 Stainless Steel Door Sleeve w/ Handle Available
- Locking Door

NEW PRODUCT!

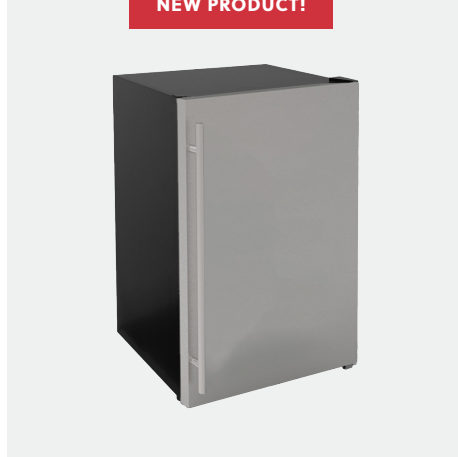

22" 4.1 Cu. DELUXE OUTDOOR APPROVED COMPACT REFRIGERATOR

RFR-22D

- Upgrades Deluxe #304 Stainless Steel Door & Handle
- Right to Left Opening Door Model Available (RFR-22D-R)
- Locking Door

FEATURES:

- Storage Capacity: 4.1 ft³
- Black Exterior & Interior Cabinet
- Black Wire Shelves (x4)
- Interior LED Light
- Full Range Mechanical Temperature Controls with 7 Settings
- Temperature Range: 0°C - 22°C / 32°F - 72°F
- 156 Can Capacity
- Energy Efficient Rating: DOE Household
- Trim Kit Available: RTK-22
- Certifications: ETL, DOE, CE



OUTDOOR RATED

REFRIGERATION

FEATURES:

- #304 Stainless Steel Door & Handle Construction
- UL Rated for Outdoor Use
- Locking Door (excludes 24DR2-A)
- Interior LED Lighting
- Front Venting
- Auto-Defrost
- Self-Closing Doors
- Electronic Temperature Controller w/ Digital Display
- Built-In Design
- Commercial & Residential Compliant
- Anti-Vibration System
- Soft-Closing Drawers
- Certifications: ETL, DOE, CE

NEW PRODUCT!



24" 5 Cu. OUTDOOR RATED DOUBLE DRAWER REFRIGERATOR

RFR-24DR2-A

- 114 Can Capacity
- 32°F - 72°F Temperature Range
- Black Interior Cabinet w/ Stainless Steel Drawers



24" 5.3 Cu. DELUXE OUTDOOR RATED REFRIGERATOR

SSRFR-24D

- 165 Can Capacity
- 32°F - 50°F Temperature Range
- #304 Stainless Steel Door & Body
- Right to Left Opening Door Model Available (SSRFR-24D-R)

NEW PRODUCT!

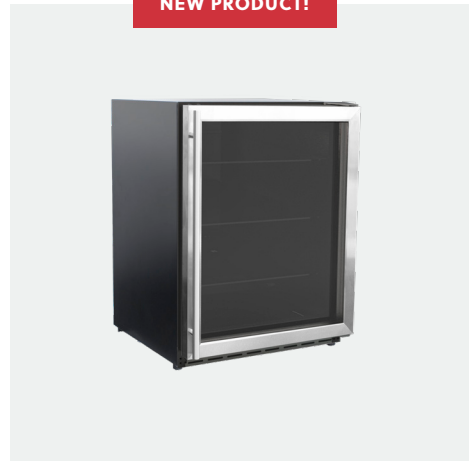

24" 5 Cu. OUTDOOR RATED REFRIGERATOR WITH GLASS DOOR

RFR-24G

- 161 Can Capacity
- 32°F - 72°F Temperature Range
- Glass Shelves (x3)
- Black Exterior & Interior Cabinet
- Triple-Glazed, Tinted Glass Door

NEW PRODUCT!



24" 5 Cu. OUTDOOR RATED REFRIGERATOR

RFR-24S-A

- Glass Shelves (x3)
- 32°F - 50°F Temperature Range
- Black Exterior & Interior
- Right to Left Opening Door Model Available (RFR-24S-AR)



15" 3.2 Cu. OUTDOOR RATED REFRIGERATOR

RFR-15S

- 32°F - 50°F Temperature Range
- #304 Stainless Steel Door & Handle



15" 3.2 Cu. OUTDOOR RATED REFRIGERATOR WITH GLASS DOOR

RFR-15G

- 32°F - 50°F Temperature Range
- Black Interior
- Triple-Glazed, Tinted Glass Door

OUTDOOR RATED

WINE COOLERS

FEATURES:

- Double-Glazed, Self-Closing, Tinted Glass Door w/ #304 Stainless Frame & Handle
- Interior LED Lighting
- Built-In Design
- UL Rated for Outdoor Use
- Front Venting
- Commercial & Residential Compliant
- Locking Doors
- Auto-Defrost
- Anti-Vibration System
- Electronic Temperature Controller w/ Digital Display
- Certifications: ETL, DOE, CE



24" 5 Cu. DELUXE OUTDOOR RATED SINGLE ZONE WINE COOLER

RFR-24W

- 46 Bottle Capacity
- Temperature Range: 41°F-64°F



24" 4.5 Cu. DELUXE OUTDOOR RATED DUAL ZONE WINE COOLER

RFR-24WD

- 46 Bottle Capacity
- Upper Temperature Range: 41°F-50°F
- Lower Temperature Range: 50°F-64°F



15" 3.2 Cu. OUTDOOR RATED SINGLE ZONE WINE COOLER

RFR-15W

- 28 Bottle Capacity
- 41°F - 64°F Temperature Range



15" 3.2 Cu. OUTDOOR RATED DUAL ZONE WINE COOLER

RFR-15WD

- 20 Bottle Capacity
- Upper Temperature Range: 41°F-50°F
- Lower Temperature Range: 50°F-64°F

OUTDOOR RATED
KEGERATORS

FEATURES:

- #304 Stainless Steel Door Construction
- UL Rated for Outdoor Use
- Locking Doors
- Interior LED Lighting
- Front Venting
- Auto-Defrost
- Electronic Temperature Controller w/ Digital Display
- Built-In Design
- Self-Closing Door
- Commercial & Residential Compliant
- Anti-Vibration System
- Certifications: ETL, DOE, CE



**24" 6.6 Cu. DELUXE OUTDOOR RATED
KEGERATOR (NO TAP / SINGLE TAP /
DOUBLE TAP)**

RFR-24DK / RFR-24DK1 / RFR-24DK2

- Available in Single or Double Tap Towers
- 32°F - 50°F Temperature Range
- Right to Left Opening Door Model Available
(RFR-24DK-R / RFR-24DK1-R / RFR-24DK2-R)



SINGLE KEG TAP FOR KEGERATOR

RFR-TAP-1

- Fits RFR-24DK
- Includes Tap Tray, Single Hose, CO2 Kit
(Tank & Regulator)



DOUBLE KEG TAP FOR KEGERATOR

RFR-TAP-2

- Fits RFR-24DK
- Includes Tap Tray, Two Hoses, CO2 Kit (Tank & Regulator)



OUTDOOR RATED
ICE MAKER



**50 LB. DELUXE OUTDOOR RATED ICE MAKER W/
GRAVITY DRAIN**

IM-15

- Daily Ice Output: 50 lbs.
- Storage Capacity: 25 lbs.
- Gravity Drain
- Temperature Control Not Necessary
- Self-Closing #304 Stainless Steel Door, Body & Handle

SINKS AND BAR PREP

Take your outdoor kitchen to the next level with our Beverage Center and selection of sinks. Complete with an ice compartment, sink, towel holder, speed rail with condiment tray, and built-in bottle opener, the Beverage Center will make you the best host in the neighborhood. Don't worry, when the sun goes down the LEDs will light it up and keep the party going!



15" DROP-IN SINK & HOT/COLD FAUCET

SNK-15D



19" UNDERMOUNT SINK & 360° HOT/COLD FAUCET

SNK-19U



FARMHOUSE SINK

SNK-32FH

*Faucet Sold Separately



30" BEVERAGE & PREP STATION

SSBC-30L

ICE CHESTS

With our grills heating things up, we have just what you need to keep cool. Choose between two sizes to optimize your serving station. With up to 40 lbs. of ice capacity, load them up with refreshments, snacks, or ingredients to make for a good time.



17" 1.7 Cu. DROP-IN COOLER (20LB ICE CAPACITY)

IC-17



28" 2.7 Cu. DROP-IN COOLER (40LB ICE CAPACITY)

IC-28

ACCESS DOORS

Our doors give you elegant and convenient access to your island, utilities, and grill. These access doors feature #304 stainless steel body & handles, hingeless design, heavy-duty flange, reversible door mounting and magnetic latches.

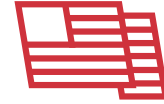

PROUDLY MADE
IN THE USA



33" VENTED DOUBLE ACCESS DOOR

DD-33V



DOUBLE ACCESS DOOR (26", 30" 32", 33", 36", 39", 40" 42", 45")

DD-26 / DD-30 / DD-32 / DD-33 / DD-36 / DD-39 / DD-40 / DD-42 / DD-45



VERTICAL ACCESS DOOR (16", 17", 18", 20")

DV-16 / DV-17 / DV-18 / DV-20

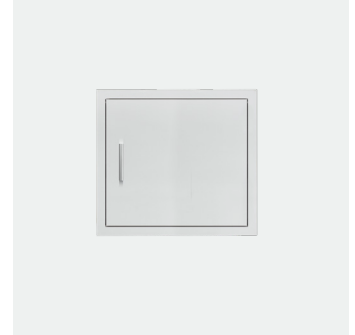

HORIZONTAL ACCESS DOOR (22", 27")

DH-22 / DH-27



16" VENTED VERTICAL ACCESS DOOR

DV-16V



18" VENTED VERTICAL ACCESS DOOR (LEFT SIDE OPENING)

DV-18VL



18" VENTED VERTICAL ACCESS DOOR (RIGHT SIDE OPENING)

DV-18VR

DOOR/DRAWER COMBOS

These hingeless components with #304 stainless steel handles are specifically designed with versatility in mind. Whether you need a simple storage setup, LP tank drawer, paper towel holder, or weather-resistant dry storage shelving, these #304 stainless steel combos give you the options you need for a perfect outdoor setup.

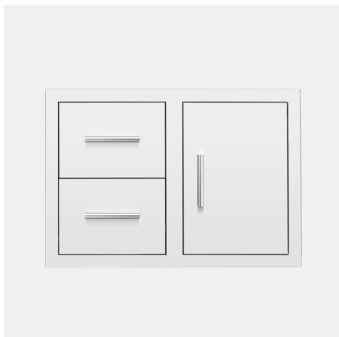

2-DRAWER & ACCESS DOOR COMBO (30", 32", 33", 36", 42")

DC2-30 / DC2-32 / DC2-33 / DC2-36 / DC2-42



33" 3-DRAWER & ACCESS DOOR COMBO

DC3-33



33" 2-DRAWER & LP TANK PULLOUT DRAWER COMBO

DC2-33LP



17" VERTICAL 2-DRAWER & PAPER TOWEL HOLDER COMBO

TDC-17

STORAGE DRAWERS

Our line of drawers are feature-packed storage options that ensure you get exactly what you need in your backyard set up. These drawers feature #304 stainless steel body & handles, heavy-duty flanges and soft closing drawers.



PROUDLY MADE
IN THE USA

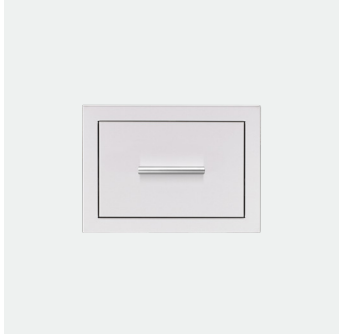

17" SINGLE DRAWER
DR1-17



17" DOUBLE DRAWER
DR2-17



17" TRIPLE DRAWER
DR3-17



**20" VENTED LIQUID PROPANE
TANK OR TRASH DRAWER**
DR1-20LP



20" TRASH PULLOUT DRAWER
TD1-20



**20" TRASH & RECYCLING
2-BIN PULLOUT DRAWER**
TD2-20

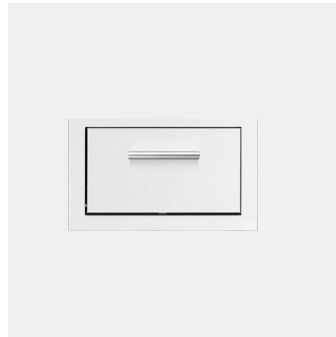

17" PAPER TOWEL HOLDER
TH-17



26" UTENSIL DRAWER
DR1-26U

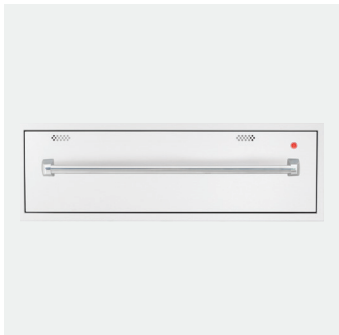

36" WARMING DRAWER
WD-36



**32" DOUBLE HORIZONTAL
DRAWER**
DR2-32H

DRY STORAGE

This line of dry storage pantries is a solution that offers heavy-duty weather-resistant seals to give you peace of mind year-round—that means moisture and critters are locked out for good. These pantries feature #304 stainless steel body & handles, hingless design, heavy-duty flanges and magnetic latches. flanges and magnetic latches.

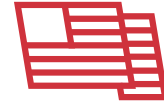

PROUDLY MADE
IN THE USA



**36" 2-DRAWER DRY STORAGE
PANTRY & ENCLOSED CABINET
COMBO**

DP-36DC



**36" 2-DRAWER DRY STORAGE
PANTRY & ACCESS DOOR
COMBO**

DP-36AC



MASONRY STORAGE

Our hingeless line of Masonry Storage, with #304 stainless steel body & handles, is perfect for islands with stone or brick finishes. . These #304 stainless steel components can also be used to add an attractive contrast to any island with stucco or Ameristone finishes.

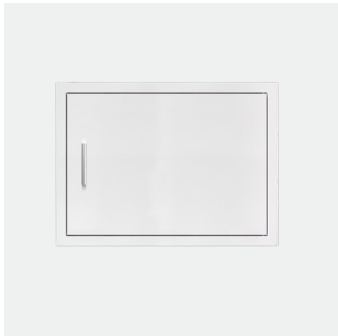

**20" MASONRY VERTICAL
ACCESS DOOR**

DV-20M

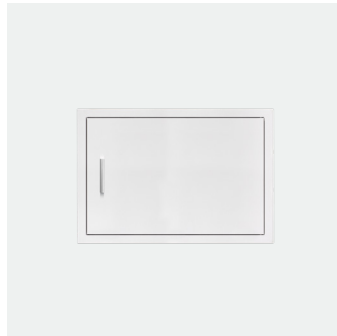

**27" MASONRY HORIZONTAL
ACCESS DOOR**

DH-27M

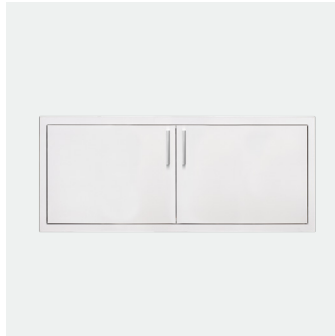

**MASONRY DOUBLE
ACCESS DOOR (33", 45")**

DD-33M / DD-45M



**20" MASONRY VENTED
LIQUID PROPANE TANK OR
TRASH DRAWER**

TD1-20M

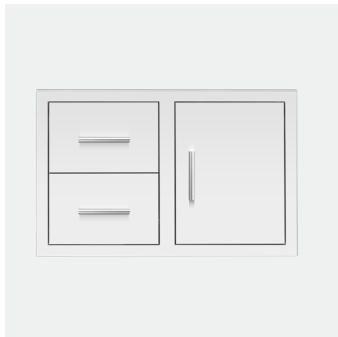

**33" MASONRY 2-DRAWER
& ACCESS DOOR COMBO**

DC2-33M



17" MASONRY DOUBLE DRAWER

DR2-17M



**17" MASONRY VERTICAL
2-DRAWER & PAPER TOWEL
HOLDER COMBO**

TDC-17M

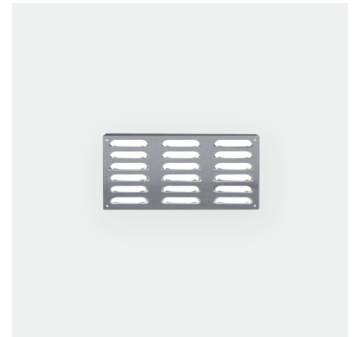

12" MASONRY ISLAND VENT PANEL

IV-12M

DROP-IN IR SEAR BURNERS

Become the chef you've dreamed of by using Summerset Sear Burners. Our sear burners can replace nearly any burner position, giving you a customizable cooking experience and allowing you to burn and turn the way you want.

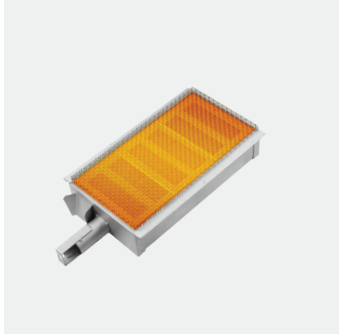

ALTURI DROP-IN INFRARED SEAR BURNER

IRB-ALT
BTU: 26,000

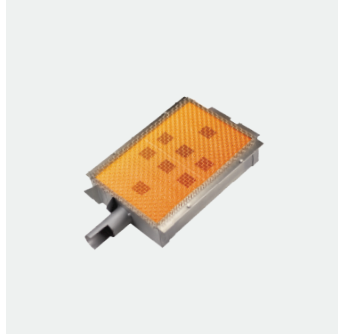

TRL/TRLD & QUEST DROP-IN INFRARED SEAR BURNER

IRB-TRL / IRB-QST
BTU: 18,000



SIZZLER DROP-IN INFRARED SEAR BURNER

IRB-SIZ
BTU: 12,000



SIZZLER PRO DROP-IN INFRARED SEAR BURNER

IRB-SIZ
BTU: 14,000

ISLAND ACCESSORIES

For a sleek and well finished outdoor kitchen, count on us to pay attention to even the smallest of details. Trim your refrigerator cutout, seal your umbrella hole and ventilate in style with Summerset's stainless steel accessories. Finishing touches make luxury islands!



REFRIGERATOR TRIM 15"/22"/24" SERIES

RTK-15 / RTK-22 / RTK-24SM
RTK-24LG



14" ISLAND VENT PANEL

IV-14



1.75" / 2" UMBRELLA COUNTERTOP MOUNTING STANCHION

US-1 / US-1L



12" X 6" ISLAND VENT PANEL W/ MASONRY FRAME RETURN

IV-12M

GRILL & SIDE BURNER LINERS

Summerset Grill Liners are designed with #304 stainless steel construction to protect any outdoor kitchen made of combustible material. The fitted Grill Liners provide an inch of double-walled insulation that blocks the heat from reaching combustible surfaces or framing such as wood or plastic, giving you the freedom to create your outdoor kitchen in the material of your choice.



GRILL LINER

GL-30 / GL-36 / GL-42 / GL-SIZ26
GL-SIZ32 / GL-SIZ40 / GL-TRL32
GL-TRL38 / GL-TRL44 / GL-GRID30
GL-QST30 / GL-QST36 / GL-QST42



SIDE BURNER LINER

GL-TRLPB2 GL-ASB2 / GL-APB2 / GL-SIZPROP
GL-QSTSB2 / GL-QSTPB

*ACCESS MAY DIFFER BASED ON MODEL



SIDE BURNER LINER -TRL / SIZ

GL-TRLSB2 / GL-SIZSB2



14" GRIDDLE PLATE

GP-14

GRIDDLES

ROTISSERIE KITS AND BAGS

Complete with weather-protected stainless steel motor, fork set, counterbalance and a spit rod for every grill model, the Summerset Rotisserie Kits have everything you need to start cooking your chicken, turkey, loin or roast like a pro.



SUMMERSET 40 LB ROTISSERIE KIT

ROTKIT-TRL32 / ROTKIT-38 /
ROTKIT-TRLD44 / ROTKIT-ALT30-A
ROTKIT-ATL36-A / ROTKIT-ALT42-A
ROTKIT-TRL38 / ROTKIT-SIZ26 /
ROTKIT-SIZ32 / ROTKIT-SIZ40



ROTISSERIE KIT STORAGE BAG

GRILLCOV-ROT32 / GRILLCOV-ROT44

*ROTISSERIE KIT SOLD SEPARATELY

APPLIANCE COVERS

Protect your outdoor kitchen appliances with Summerset Grill Covers. Our heavy-duty PVC covers are 100 percent water-resistant, UV-protected to prevent fading, custom fitted, and feature soft flannel backing (to keep your steel scratch-free). Covers available for Grills, Griddles, Side Burners, & Ovens.



GRILL COVER

GRILLCOV(-ALT30D, -ALT36D,
-ALT42D, -26D, -32D, -38/40D, -44D)



CART COVER

CARTCOV(-ALT30D, -ALT36D,
-ALT42D, -26D, -32D, -38/40D, -44D
-QST30D, -QST36D, -QST42D)



SIDE & POWER BURNER COVER

GRILLCOV(-SIZSB2, -SB1, -SB2, -PB,
-ALTSB2, -APB2)



BUILT-IN OVEN COVER

GRILLCOV-OVBI

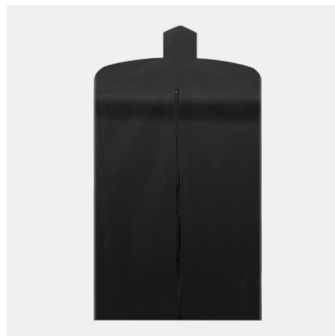

FREESTANDING OVEN COVER

CARTCOV-OVFS



30" GAS GRIDDLE COVER

GRILLCOV-GRID30

GAS TIMER / MOUNTING PLATE



GAS TIMER WITH EMERGENCY SHUTOFF / MOUNTING PLATE
ESTOP1-0H

*MOUNTING PLATE SOLD SEPARATELY

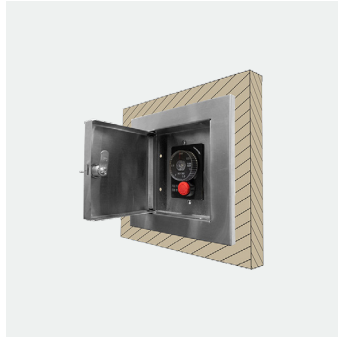

GAS TIMER LOCKING CABINET
ESTOP-LC-KIT / ESTOP-RM-KIT



EXPANDABLE MASONRY GAS TIMER KIT
ESTOP-CP-KIT

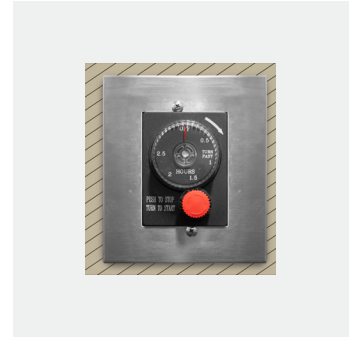

GAS TIMER RECESS MOUNT KIT
ESTOP-RM-KIT

BURNER BRACKET



SIDE BURNER BRACKET
CART-SIZ-SB2BK-R / CART-SIZ-SB2BK-L

WIND GUARDS



36" STAINLESS STEEL WIND GUARD (FITS 26"-32" GRILLS)
SSWG-36



48" STAINLESS STEEL WIND GUARD (FITS 36"-44" GRILLS)
SSWG-48

VENT HOODS



VENT HOODS (36", 42", 48", 60")
VH36-2 / VH42-2 / VH48-2 / VH60-2



12" DUCT COVER (36", 42", 48", 60")
VH36-2-DC / VH42-2-DC
VH48-2-DC / VH60-2-DC



SPACER TEMPLATE
VH36-2-SPT / VH42-2-SPT
VH48-2-SPT / VH60-2-SPT



SPACER BRACKETS (4", 8")
VH36-2-SP4 / VH36-2-SP8
VH42-2-SP4 / VH42-2-SP8
VH48-2-SP4 / VH48-2-SP8
VH60-2-SP4 / VH60-2-SP8

CUTTING BOARD & TRASH CHUTE

Add convenience to your outdoor kitchen with the Summerset Grills Cutting Board & Trash Chute. Add the Trash Chute above Summerset's Trash Drawer for easy cleanup. Made from #304 Stainless Steel, Summerset's Trash Chute is durable even in the harshest weather.



14" TRASH CHUTE & CUTTING BOARD WITH LID
TC-14

SMOKER TRAYS

Add some pizzazz to an otherwise ordinary meal with the Summerset Smoker Tray. Whether it's mesquite chicken or applewood smoked salmon, the smoker tray is the ultimate meal enhancer that allows for endless flavor options.



SMOKER TRAYS
SSMK-SIZ / SSMK-TRL



ALTURI SMOKER TRAY
SSMK-ALT

OVEN ACCESSORIES

Here are all the included tools that you will need for a successful night of pizza making. Be sure you use that glove, because this pizza will be coming out of the oven hot!



PIZZA STONE KIT
SSTOAK-1



FLANGE KIT
OV-FLANG KIT



Product Dimensions

ALT30/SBG30

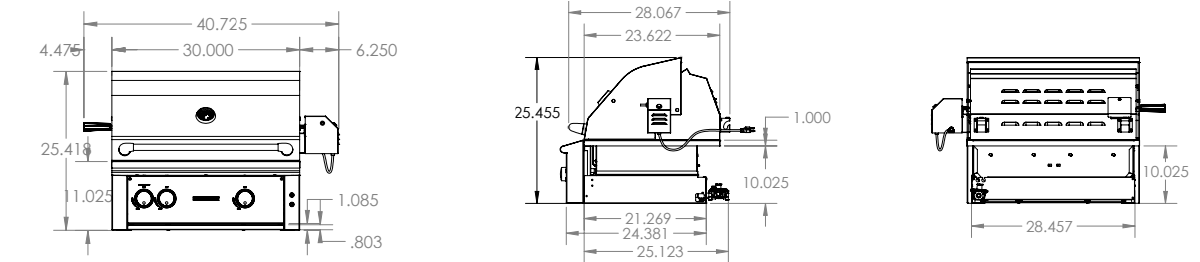

ALT 36

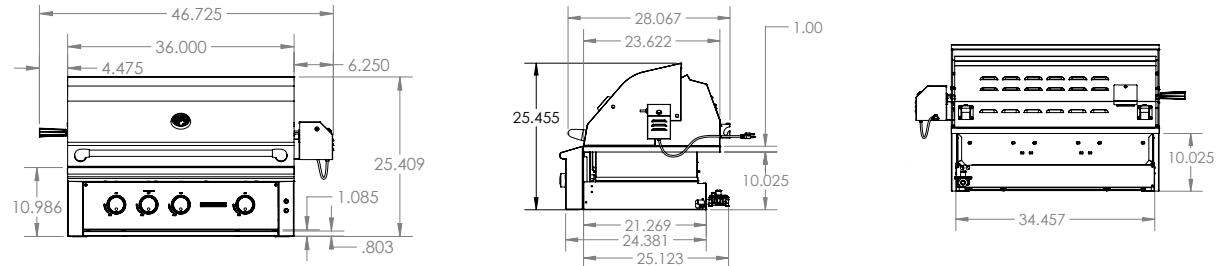

ALT 42

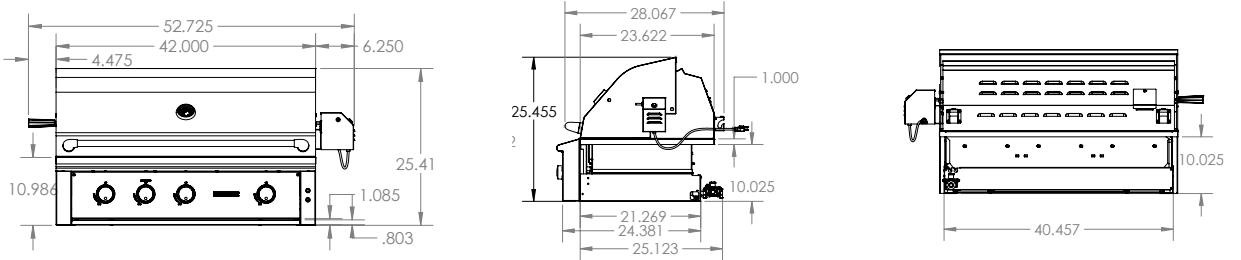

QST 30

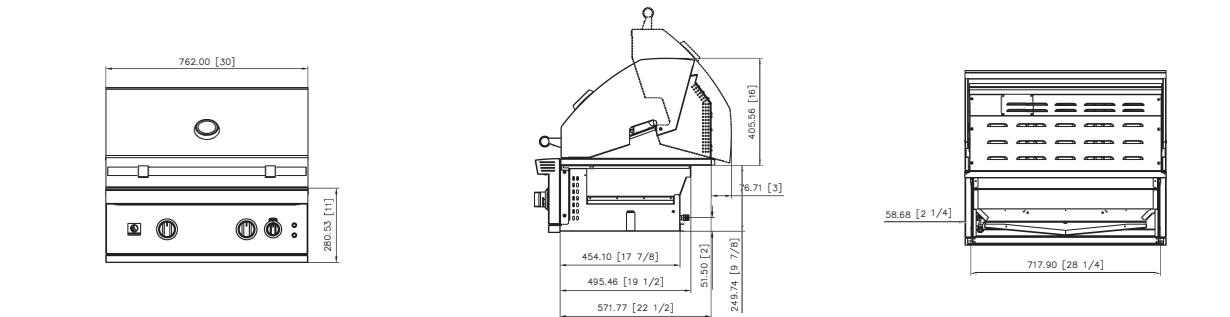

QST 36

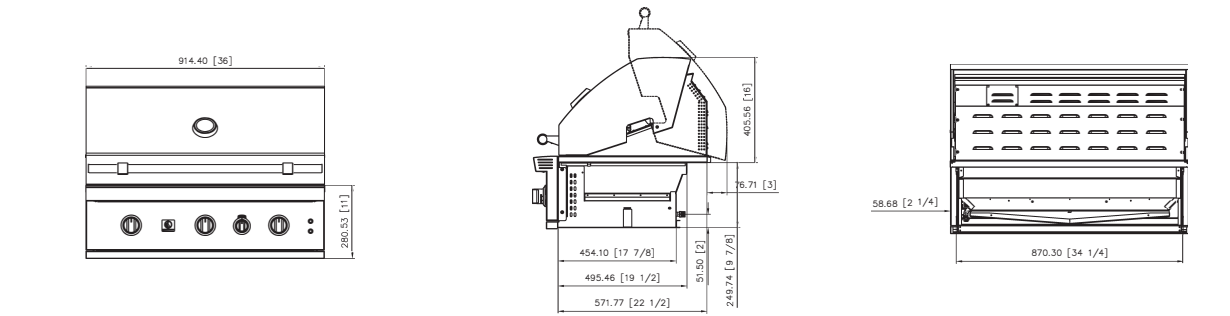

QST 42

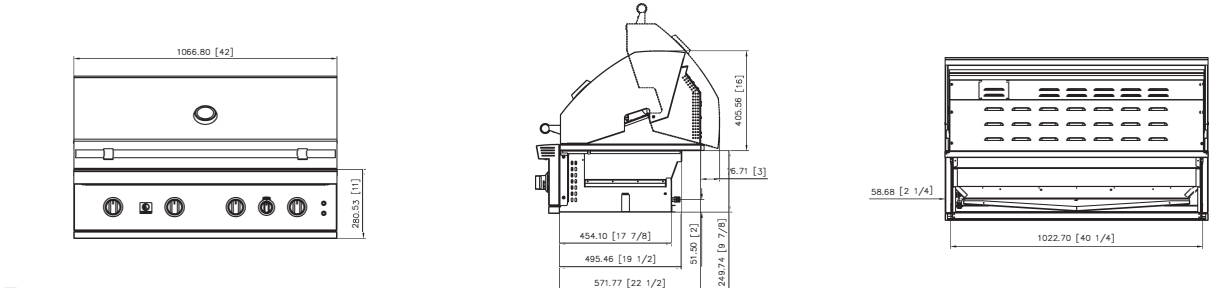

For cutouts, dimensions or more information on your Summerset product, visit Summersetgrills.com/cutouts or scan this QR Code with your smartphone's camera app.



SIZ26

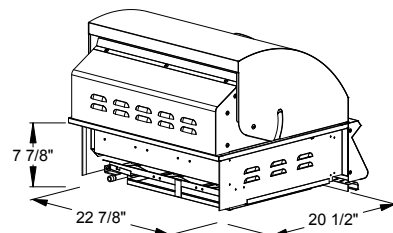
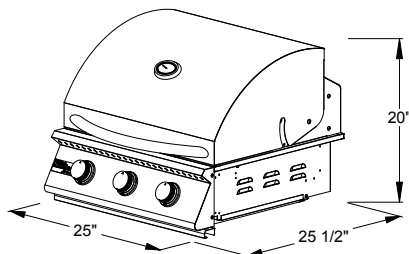

SIZ32 / SIZPRO32

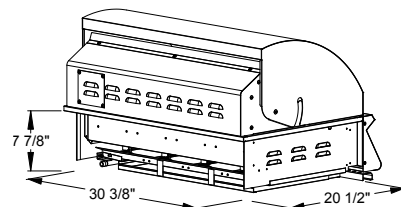
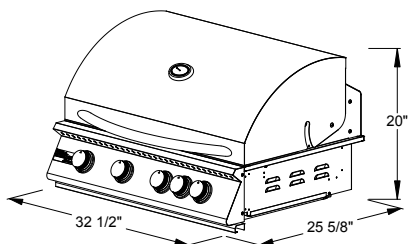

SIZ40 / SIZPRO40

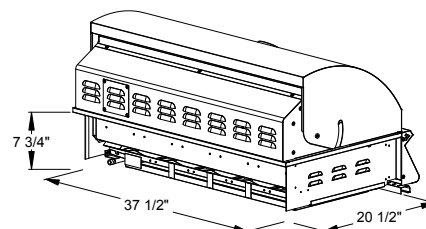
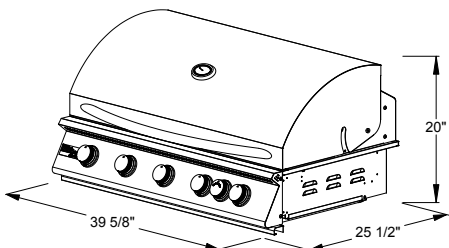

TRL32

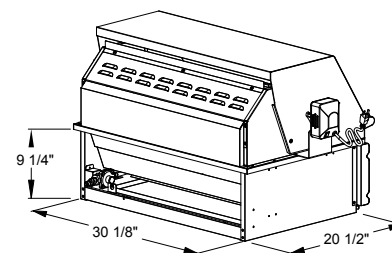
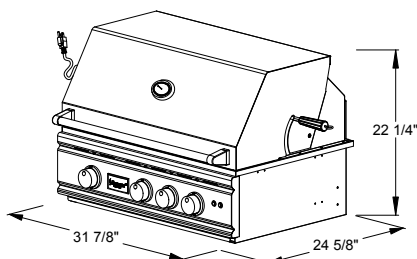

TRL38

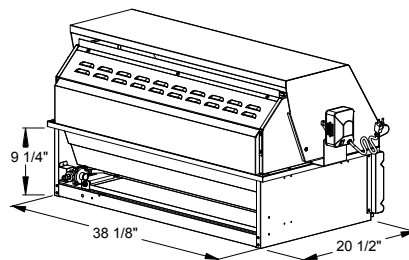
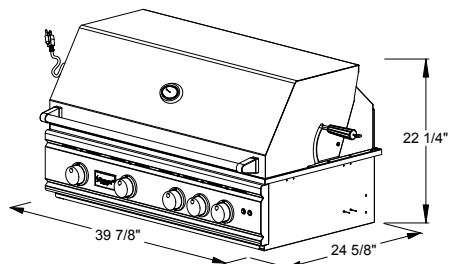

TRLD44

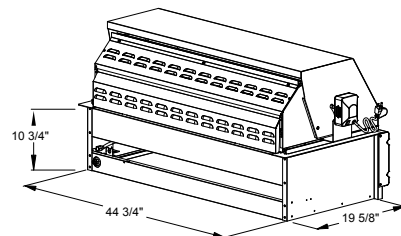
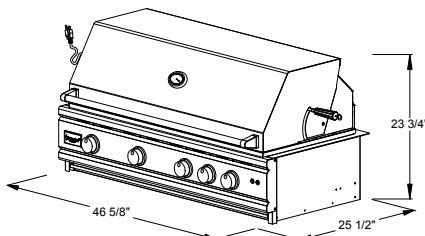

Product Dimensions

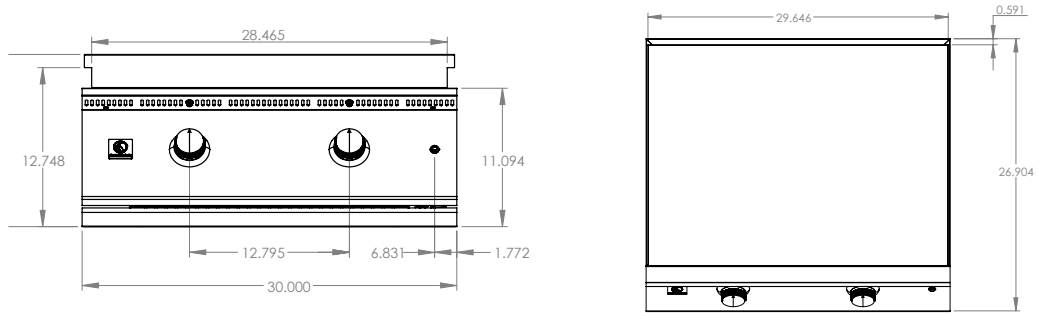

GRIDPRO / GRID 30

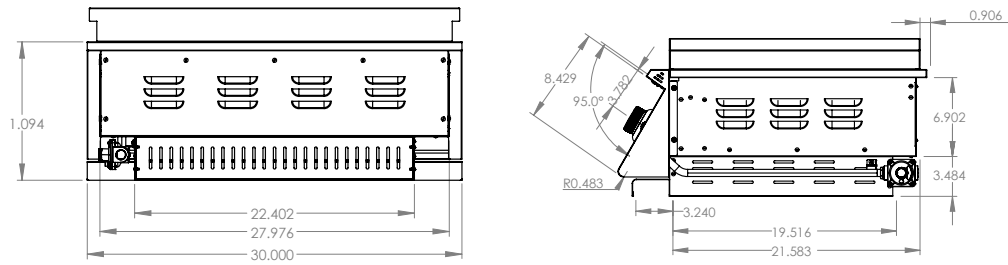

SS-OVBI

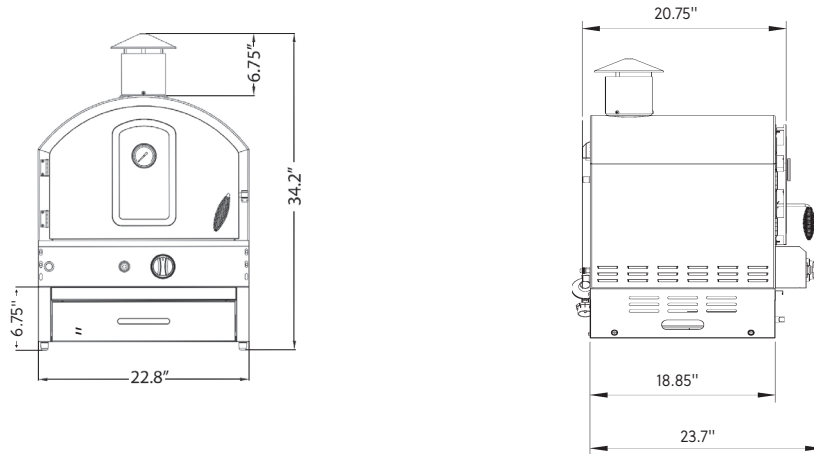

OV-HYB

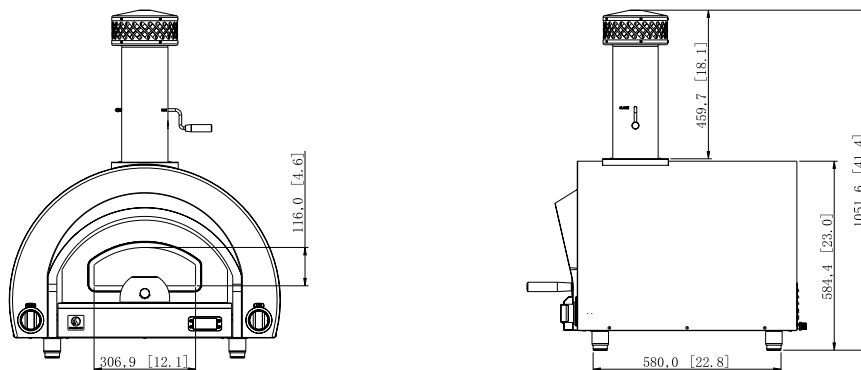

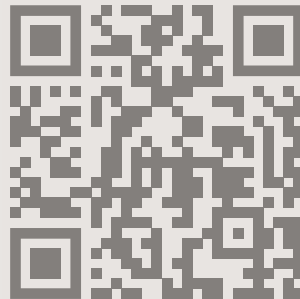

**Scan this QR code to see
warranty details**



14520 Delta Ln, Suite 105
Huntington Beach, CA 92647
(800) 966-8126
SUMMERSETGRILLS.COM